

ANALOG CLOCK IC WITH SNOOZE FUNCTION

■ GENERAL DESCRIPTION

The NJU6304 is an analog clock IC driving a stepping motor with soft start alarm and snooze function.

It consists of a quartz crystal oscillator, frequency divider, output pulse generators, push-pull motor drivers, alarm with snooze function controller and alarm output.

The alarm with snooze function controller performs soft-start gradual-increase alarm sound repeated with a constant pre-fixed interval period until stopped.

The input and output of the quartz crystal oscillator are provided with oscillation capacitors. Consequently, only a quartz crystal is required as the external component.

The motor driving pulse width made by output pulse generators, alarm modulation pattern and alarm active level are all option.

■ FEATURES

- Soft Start Alarm Sound
- Snooze Function
- Low Operating Current -- 1uA typ.
- Oscillation Capacitor On-chip
- Operating Voltage --- 1.5V
- Package Outline ---- DIP/DMP 8
- C-MOS Technology

■ PACKAGE OUTLINE

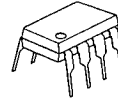

NJU6304XD



NJU6304XM

■ PIN CONFIGURATION

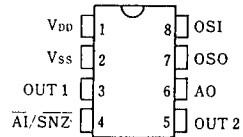

■ LINE-UP

Version	Motor Driving		Alarm Output			AI/SNZ	Int.Capacitor	
	Pulse Width	Active	Fundamental	Modulation	Active		C <sub>I</sub>	C <sub>O</sub>
B	31.25ms	H	2 kHz	8Hz+1Hz	H	AI	2pF	23pF

■ BLOCK DIAGRAM

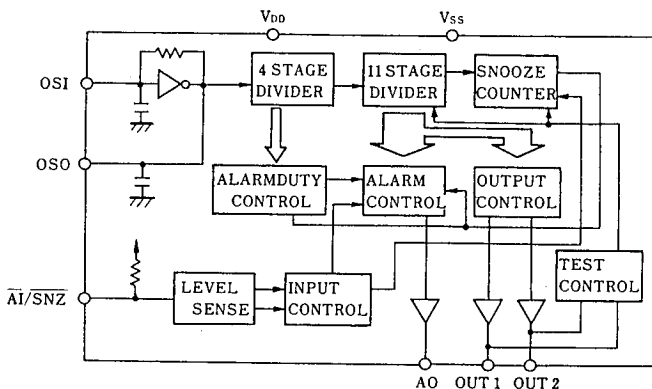

**■ TERMINAL DESCRIPTION**

NO.	SYMBOL	F U N C T I O N
1	V <sub>DD</sub>	+1.5V
2	V <sub>SS</sub>	GND
3	OUT1	Stepping Motor Driving Terminal. Active "H"
4	$\overline{AI/SNZ}$	Alarm/Snooze Input Terminal. When this terminal level change from "H" to "L" during alarm ringing or in snooze period, the snooze function is restarted.
5	OUT2	Stepping Motor Driving Terminal. Active "H"
6	AO	Alarm Output Terminal. Active "H"
7	OSD	Quartz Crystal Connecting Terminal. On-chip capacitance=30pF Max. (Refer the Line-up table for actual capacitance value)
8	OSI	Quartz Crystal Connecting Terminal. On-chip capacitance=15pF Max. (Refer the Line-up table for actual capacitance value)

**■ FUNCTIONAL DESCRIPTION**

## (1) Motor Driving Output

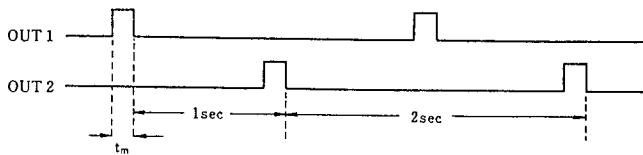

## (2) Alarm Output Waveform

Alarm signal of the following pattern is output from the Alarm Output Terminal.  
(Pin No.6)

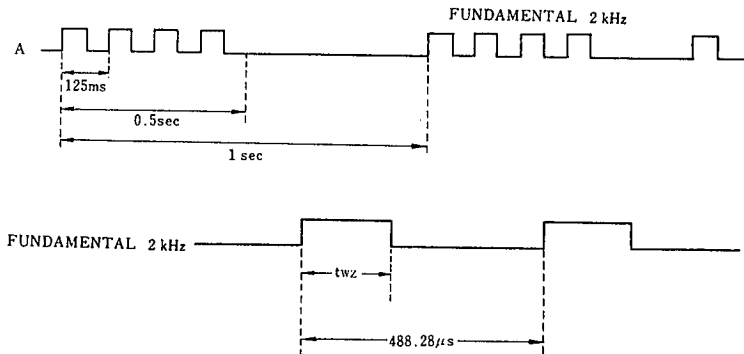

## (3) Alarm Duty

Alarm	0~8sec	8~16sec	16~32sec	32~128sec
twz	30.5us	61.0us	122.1us	244.1us
duty	6.25%	12.5%	25.0%	50.0%

## (4) Alarm Input/User Test

When  $1/2V_{DD}$  level is input on pin No.4, AO output the continuous waveform for frequency adjustment shown below.

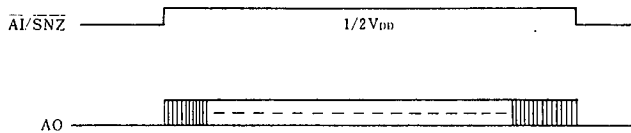
 (5)  $\overline{AI/SNZ}$  function

When this terminal level change from "H" to "L" during alarm ringing or in snooze period, the snooze frequency is restarted. After 256sec of snooze period, the alarm sound output for 128sec.

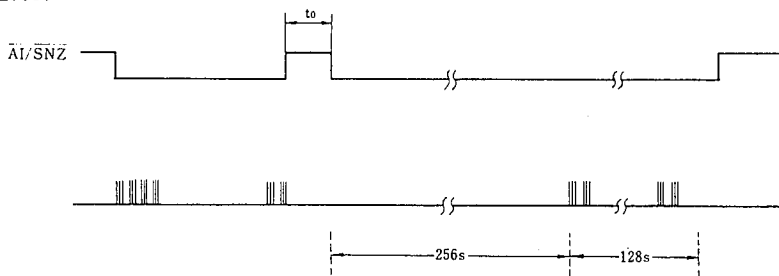

If the  $t_o$  input is over 8.0sec, the snooze is canceled and 4.0 to 8.0sec is unfixed(cancel or not cancel).

## (6) Snooze Speed Test

When OUT1 and OUT2 level is "H",snooze time is shortened to 0.25sec.

**ABSOLUTE MAXIMUM RATINGS**

 (  $T_a=25^{\circ}\text{C}$  )

PARAMETER	SYMBOL	RATINGS	UNIT
Supply Voltage	$V_{DD}$	- 0.3 ~ 7.0	V
Input Voltage	$V_{IN}$	- 0.3 ~ $V_{DD}+0.3$	V
Power Dissipation	$P_D$	( DIP ) 250 ( DMP ) 200	mW
Operating Temperature	$T_{opr}$	- 20 ~ + 70	$^{\circ}\text{C}$
Storage Temperature	$T_{stg}$	- 40 ~ + 150	$^{\circ}\text{C}$
Soldering Temperature	$T_{SLD}$	260	$^{\circ}\text{C}$
Soldering Time	$t_{SLD}$	10	sec

**■ ELECTRICAL CHARACTERISTICS**

 (V<sub>DD</sub>-V<sub>SS</sub>=1.5V, T<sub>a</sub>=25°C)

PARAMETER	SYMBOL	CONDITIONS	MIN	TYP	MAX	UNIT
Operating Voltage	V <sub>DD</sub>		1.1		2.0	V
Operating Current	I <sub>DD</sub>	No Load		1.0	2.0	μA
Motor Driving Current	I <sub>M</sub>	V <sub>DD</sub> =1.2V, R <sub>L</sub> =200Ω	4.0			mA
Alarm Output Current	I <sub>OH</sub>	V <sub>DD</sub> =1.2V, V <sub>OH</sub> =0.7V	0.3			mA
	I <sub>OL</sub>	V <sub>DD</sub> =1.2V, V <sub>OL</sub> =0.5V	0.3			
Input Voltage	V <sub>IH</sub>	No.4 Terminal ( $\overline{AI}$ or $\overline{SNZ}$ )	V <sub>DD</sub> -0.2		V <sub>DD</sub>	V
	V <sub>IL</sub>		V <sub>SS</sub>		V <sub>SS</sub> +0.2	
	V <sub>TEST</sub>		0.9*1/2V <sub>DD</sub>	1/2V <sub>DD</sub>	1.1*1/2V <sub>DD</sub>	
Input Resistance	R <sub>IN</sub>		0.1	0.5	1.0	MΩ
Oscillation Stability	Δf/f			0.5	1.0	ppm/0.1V
Oscillation Capacitor	C <sub>O</sub>	f=100kHz	-7%	Note	+7%	pF
	C <sub>I</sub>					

Note) Typical value of on-chip capacitor is mentioned in Line-up table.

# NJU6304 Series

---

MEMO

**[CAUTION]**

The specifications on this databook are only given for information, without any guarantee as regards either mistakes or omissions. The application circuits in this databook are described only to show representative usages of the product and not intended for the guarantee or permission of any right including the industrial rights.