

PLEASE CHECK WWW.MOLEX.COM FOR LATEST PART INFORMATION

Part Number: [0879140616](#)
Status: **Active**
Overview: [cgrid_sl_products](#)
Description: 2.54mm (.100") Pitch C-Grid® Header, Through Hole, Dual Row, Vertical, 6 Circuits, 2.50µm (98.4µ") Tin (Sn) Overall Plating, Tray Packaging, Lead-free

Documents:

[3D Model](#) [Product Specification PS-87920-019 \(PDF\)](#)
[Drawing \(PDF\)](#) [RoHS Certificate of Compliance \(PDF\)](#)

Agency Certification

UL E29179

General

Product Family PCB Headers
 Series [87914](#)
 Application Board-to-Board, Wire-to-Board
 Overview [cgrid_sl_products](#)
 Product Name C-Grid®

Physical

Breakaway Yes
 Circuits (Loaded) 6
 Circuits (maximum) 6
 Color - Resin Black
 First Mate / Last Break No
 Flammability 94V-0
 Glow-Wire Compliant No
 Guide to Mating Part No
 Keying to Mating Part None
 Lock to Mating Part None
 Mated Height (in) 0.230 In
 Mated Height (mm) 5.84 mm
 Material - Metal Copper Alloy
 Material - Plating Mating Tin
 Material - Plating Termination Nickel
 Material - Resin High Temperature Thermoplastic
 Number of Rows 2
 Orientation Vertical
 PC Tail Length (in) 0.110 In
 PC Tail Length (mm) 2.79 mm
 PCB Locator No
 PCB Retention None
 PCB Thickness Recommended (in) 0.062 In
 PCB Thickness Recommended (mm) 1.60 mm
 Packaging Type Tray
 Pitch - Mating Interface (in) 0.100 In
 Pitch - Mating Interface (mm) 2.54 mm
 Pitch - Term. Interface (in) 0.100 In
 Pitch - Term. Interface (mm) 2.54 mm
 Plating min: Mating (µin) 98
 Plating min: Mating (µm) 2.50
 Plating min: Termination (µin) 49
 Plating min: Termination (µm) 1.25
 Polarized to Mating Part No
 Polarized to PCB No

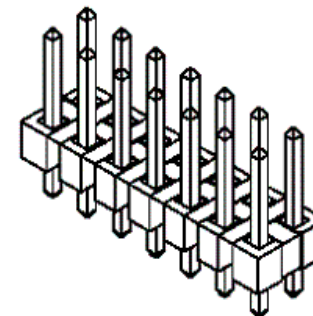

Series

image - Reference only

EU RoHS

ELV and RoHS Compliant
REACH SVHC
 Not Reviewed
Halogen-Free Status
Not Reviewed

China RoHS



Need more information on product environmental compliance?

Email productcompliance@molex.com
 For a multiple part number RoHS Certificate of Compliance, [click here](#)

Please visit the [Contact Us](#) section for any non-product compliance questions.

Search Parts in this Series

[87914Series](#)

Mates With

7859 Shunts. C-Grid® PCB Receptacles like 71850. [SL™](#) IDT Housing like 70450

Shrouded	No
Stackable	No
Surface Mount Compatible (SMC)	Yes
Temperature Range - Operating	-55°C to +105°C
Termination Interface: Style	Through Hole

Electrical

Current - Maximum per Contact	3A
Voltage - Maximum	250V

Solder Process Data

Duration at Max. Process Temperature (seconds)	12
Lead-free Process Capability	Wave Capable (TH only)
Max. Cycles at Max. Process Temperature	1
Process Temperature max. C	260

Material Info

Reference - Drawing Numbers

Packaging Specification	PK-89990-489
Product Specification	PS-87920-019
Sales Drawing	SD-87914-013

This document was generated on 05/25/2010

PLEASE CHECK WWW.MOLEX.COM FOR LATEST PART INFORMATION

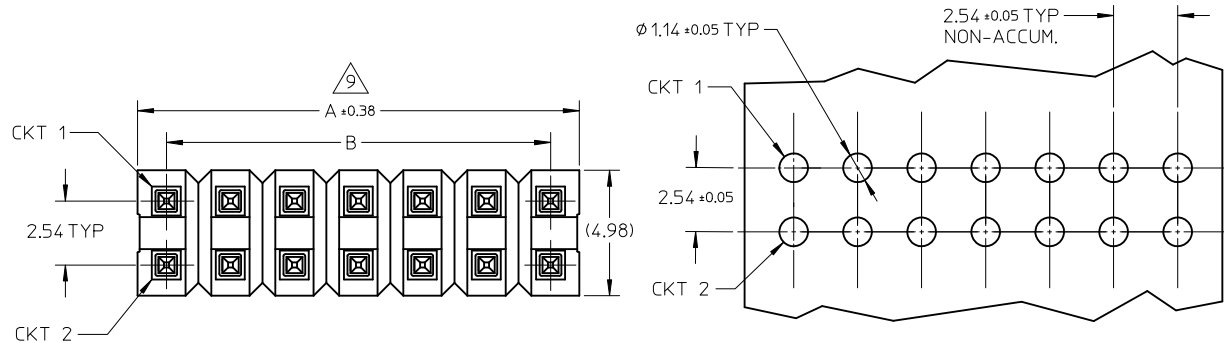

RECOMMENDED P.C.B HOLE LAYOUT

NOTES:

1. MATERIAL:
 - HSG: LCP, GLASS-FILLED, UL94V-0, COLOR: BLACK
 - PIN: 0.64MM SQ PIN, COPPER ALLOY
2. PLATING TYPE:
 - (1) : GOLD FLASH OVER
1.25 MICRO METER MIN. NICKEL OVERALL.
 - (2) : 0.025 μm MIN. GOLD PLATE ON CONTACT AND 1.88 μm MIN. TIN ON SOLDERTAIL OVER 1.25 μm MIN. NICKEL OVERALL.
 - (3) : 0.25 μm MIN. GOLD PLATE ON CONTACT AND 1.88 μm MIN. TIN ON SOLDERTAIL OVER 1.25 μm MIN. NICKEL OVERALL.
 - (4) : 0.38 μm MIN. GOLD PLATE ON CONTACT AND 1.88 μm MIN. TIN ON SOLDERTAIL OVER 1.25 μm MIN. NICKEL OVERALL.
 - (5) : 0.75 μm MIN. GOLD PLATE ON CONTACT AND 1.88 μm MIN. TIN ON SOLDERTAIL OVER 1.25 μm MIN. NICKEL OVERALL
 - (6) : 2.50 μm MIN. TIN IN SELECTED AREA OVER 1.25 μm MIN. NICKEL OVERALL.
 - (7) : 0.38 μm MIN. GOLD PLATE ON CONTACT AND 2.50 μm MIN. TIN ON SOLDERTAIL OVER 1.25 μm MIN. NICKEL OVERALL.
 - (8) : 0.38 μm MIN. GOLD PLATE ON CONTACT AND 0.05 μm MIN. GOLD FLASH ON SOLDERTAIL OVER 1.25 μm MIN. NICKEL OVERALL.
3. PIN PUSHOUT FORCE: 1KG MIN IN EITHER DIRECTION
4. THE ABOVE 14 CKT IS FOR ILLUSTRATION PURPOSE ONLY.
5. FOR PACKAGING OPTION PLEASE REFER TO THE TABLE.
6. RECOMMENDED PCB THICKNESS 1.60MM.
7. PRODUCT SPECIFICATION: PS-87920-019
8. WAFER TO BE FLAT WITHIN 0.003mm/mm
9. IRREGULAR CIRCUIT CUTOFF WITHIN BREAKAWAY SECTION IS PERMISSIBLE. CUTTING OR CHIPPING OF THE MAIN BODY IS NOT ACCEPTABLE.
10. PARTS ARE NOT STACKABLE ON 2.54 CENTER
11. CAP TO BE PLACED AS CENTRAL OF PART AS POSSIBLE WITH THE TOP SURFACE FLAT FOR PICK AND PLACE.
12. PACKAGING SPECIFICATION:
 - TRAY: PK-89990-489
 - BULK: PK-89990-491

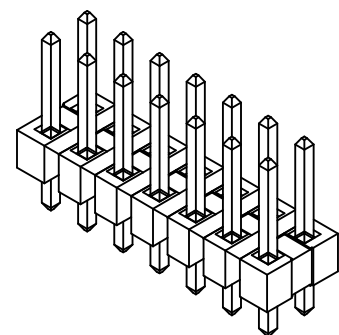
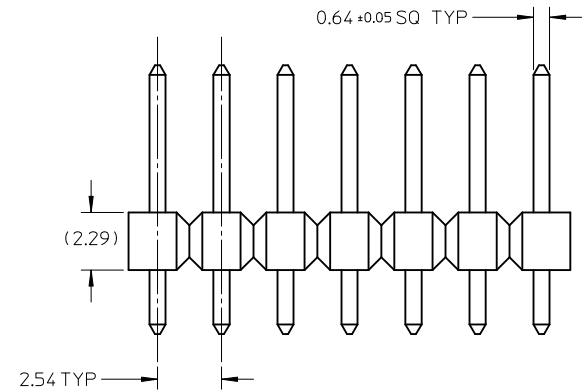

PG8. +879140108 EC NO: S2010-0695 DRWN:ATSEE 2010/02/11 CHKD:PTLIM 2004/12/08 APPR:MLONG 2010/06/05 REV D7	QUALITY SYMBOLS	GENERAL TOLERANCES (UNLESS SPECIFIED)	DIMENSION STYLE	SCALE	DESIGN UNITS	THIRD ANGLE PROJECTION															
	$\nabla_A = 0$ $\nabla_C = 0$ $\nabla_P = 0$	<table border="1"> <tr> <th></th> <th>mm</th> <th>INCH</th> </tr> <tr> <td>4 PLACES</td> <td>± ---</td> <td>± ---</td> </tr> <tr> <td>3 PLACES</td> <td>± ---</td> <td>± ---</td> </tr> <tr> <td>2 PLACES</td> <td>± 0.20</td> <td>± ---</td> </tr> <tr> <td>1 PLACE</td> <td>± ---</td> <td>± ---</td> </tr> </table>		mm	INCH	4 PLACES	± ---	± ---	3 PLACES	± ---	± ---	2 PLACES	± 0.20	± ---	1 PLACE	± ---	± ---	MM ONLY	N/T S	METRIC	
		mm	INCH																		
	4 PLACES	± ---	± ---																		
3 PLACES	± ---	± ---																			
2 PLACES	± 0.20	± ---																			
1 PLACE	± ---	± ---																			
ANGULAR ± 3 °	DRAFT WHERE APPLICABLE MUST REMAIN WITHIN DIMENSIONS	DRAWN BY: KCHO CHECKED BY: PTLIM APPROVED BY: SCLOW DATE: 2004/11/05 DATE: 2004/12/08 DATE: 2004/12/10	TITLE	2.54MM PITCH DUAL ROW HEADER SINGLE WAFER, T/H																	
		SEE TABLE	MATERIAL NO.	DOCUMENT NO.	MOLEX INCORPORATED SD-87914-013																
			SIZE A3	THIS DRAWING CONTAINS INFORMATION THAT IS PROPRIETARY TO MOLEX INCORPORATED AND SHOULD NOT BE USED WITHOUT WRITTEN PERMISSION																	

P/N	CKT SIZE	F	So	W	QTY/ REEL
87914-0627	06	11.50	-	24.00	250
87914-0827	08	11.50	-	24.00	250

FOR TAPE WIDTH WITH SINGLE ROW SPROCKET HOLES.

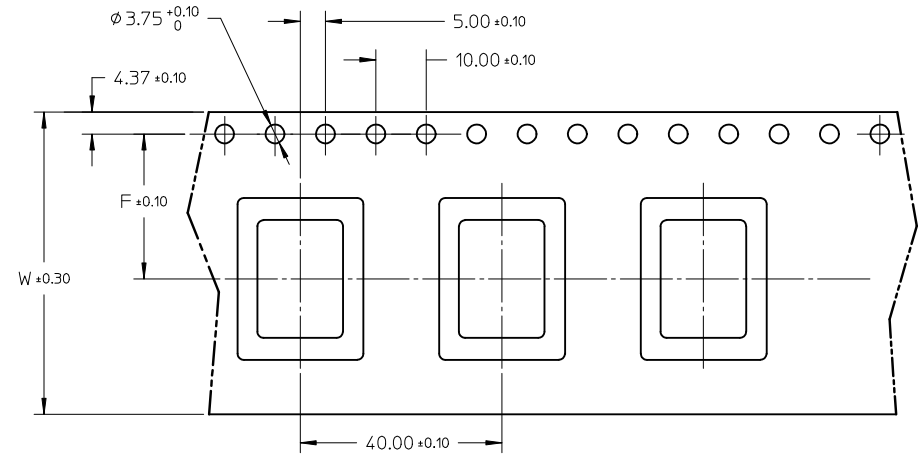

CUSTOMER PULL OUT DIRECTION

FOR TAPE WIDTH WITH 2 ROWS OF SPROCKET HOLES.

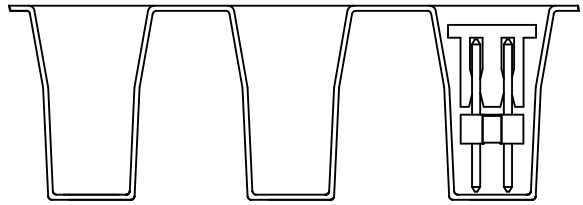
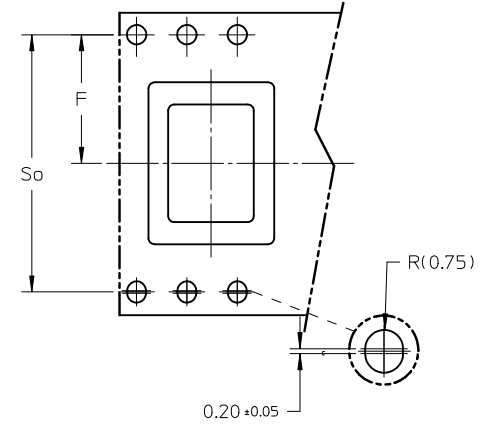

VIEW OF PART ORIENTATION IN TAPE & REEL

NOTES:

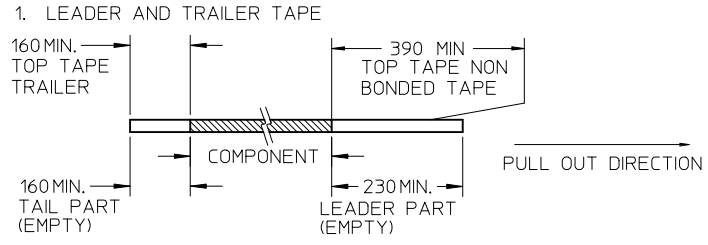

2. PEELING OFF FORCE OF THE TOP TAPE: 20 - 80gf. (PEELING DIRECTION AS SHOWN IN FOLLOWING FIGURE)

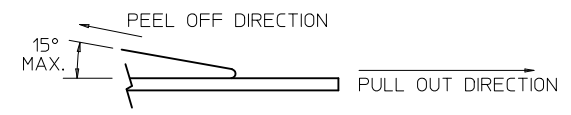

3. TAPE AND REEL SPECIFICATION IS AS PER EIA-481.
4. THE TAPE IS TREATED FOR ANTI-STATIC.

REV	DESCRIPTION	QUALITY SYMBOLS	GENERAL TOLERANCES (UNLESS SPECIFIED)		DIMENSION STYLE	SCALE	DESIGN UNITS	THIRD ANGLE PROJECTION		
			mm	INCH	MM ONLY	NTS	METRIC	⊙		
D7	PG8. +879140108 EC NO: S2010-0695 DRWN:ATSEE 2010/02/11 CHKD:PTLIM 2004/12/08 APPR:MLONG 2010/06/05	$F_A=0$ $F_C=0$ $F_P=0$	4 PLACES ± --- ± ---	3 PLACES ± --- ± ---	2 PLACES ± 0.20 ± ---	1 PLACE ± --- ± ---	ANGULAR ± 3 °	DRAFT WHERE APPLICABLE MUST REMAIN WITHIN DIMENSIONS	DRAWN BY: KCHO CHECKED BY: PTLIM APPROVED BY: SCLOW DATE: 2004/11/05 DATE: 2004/12/08 DATE: 2004/12/10 MATERIAL NO.: SEE TABLE DOCUMENT NO.: SD-87914-013	TITLE: 2.54MM PITCH DUAL ROW HEADER SINGLE WAFER, T/H MOLEX INCORPORATED SHEET NO.: 2 OF 46

	10	9	8	7	6	5	4	3	2	1			
	PART NO FOR TRAY PACKAGING	PART NO. FOR TUBE WITHOUT CAP PACKAGING	PART NO. FOR TUBE WITH CAP PACKAGING	PART NO. FOR TAPE & REEL WITHOUT CAP PACKAGING	PART NO. FOR TAPE & REEL WITH CAP PACKAGING	CKT SIZE	VOID POSITION	PLATING TYPE	DIMENSION				
								A	B	F	M	P	
F	87914-0211	-----	-----	-----	-----	2	----	1	2.54	----	10.92	5.84	2.79
	87914-0221	-----	-----	-----	-----	2	----	1	2.54	----	12.25	7.00	2.96
	87914-0231	-----	-----	-----	-----	2	----	1	2.54	----	13.38	6.09	5.00
	87914-0212	-----	-----	-----	-----	2	----	2	2.54	----	10.92	5.84	2.79
	87914-0222	-----	-----	-----	-----	2	----	2	2.54	----	12.25	7.00	2.96
	87914-0232	-----	-----	-----	-----	2	----	2	2.54	----	13.38	6.09	5.00
E	87914-0213	-----	-----	-----	-----	2	----	3	2.54	----	10.92	5.84	2.79
	87914-0223	-----	-----	-----	-----	2	----	3	2.54	----	12.25	7.00	2.96
	87914-0233	-----	-----	-----	-----	2	----	3	2.54	----	13.38	6.09	5.00
	87914-0214	-----	-----	-----	-----	2	----	4	2.54	----	10.92	5.84	2.79
	87914-0224	-----	-----	-----	-----	2	----	4	2.54	----	12.25	7.00	2.96
	87914-0234	-----	-----	-----	-----	2	----	4	2.54	----	13.38	6.09	5.00
D	87914-0215	-----	-----	-----	-----	2	----	5	2.54	----	10.92	5.84	2.79
	87914-0225	-----	-----	-----	-----	2	----	5	2.54	----	12.25	7.00	2.96
	87914-0235	-----	-----	-----	-----	2	----	5	2.54	----	13.38	6.09	5.00
	87914-0216	-----	-----	-----	-----	2	----	6	2.54	----	10.92	5.84	2.79
	87914-0226	-----	-----	-----	-----	2	----	6	2.54	----	12.25	7.00	2.96
	87914-0236	-----	-----	-----	-----	2	----	6	2.54	----	13.38	6.09	5.00
C													
B													

PG8. +879140108 EC NO: S2010-0695 DRWN:ATSEE 2010/02/11 CHKD:PTLIM 2004/12/08 APPR:MLONG 2010/06/05	QUALITY SYMBOLS $F_A=0$ $F_G=0$ $F_P=0$	GENERAL TOLERANCES (UNLESS SPECIFIED)		DIMENSION STYLE MM ONLY		SCALE NTS	DESIGN UNITS METRIC	THIRD ANGLE PROJECTION				
				mm	INCH	DRAWN BY KCHO	DATE 2004/11/05	TITLE 2.54MM PITCH DUAL ROW HEADER SINGLE WAFER, T/H				
				4 PLACES	± ---	± ---	CHECKED BY PTLIM	DATE 2004/12/08	 MOLEX INCORPORATED MATERIAL NO. SEE TABLE DOCUMENT NO. SD-87914-013 SHEET NO. 3 OF 46			
				3 PLACES	± ---	± ---	APPROVED BY SCLOW	DATE 2004/12/10				
		2 PLACES	± 0.20	± ---	DRAFT WHERE APPLICABLE MUST REMAIN WITHIN DIMENSIONS							
		1 PLACE	± ---	± ---	SIZE A3		THIS DRAWING CONTAINS INFORMATION THAT IS PROPRIETARY TO MOLEX INCORPORATED AND SHOULD NOT BE USED WITHOUT WRITTEN PERMISSION					

	10	9	8	7	6	5	4	3	2	1			
	PART NO. FOR TRAY PACKAGING	PART NO. FOR TUBE WITHOUT CAP PACKAGING	PART NO. FOR TUBE WITH CAP PACKAGING	PART NO. FOR TAPE & REEL WITHOUT CAP PACKAGING	PART NO. FOR TAPE & REEL WITH CAP PACKAGING	CKT SIZE	VOID POSITION	PLATING TYPE	DIMENSION				
								A	B	F	M	P	
F	87914-0411	-----	-----	-----	-----	4	----	1	5.08	2.54	10.92	5.84	2.79
	87914-0421	-----	-----	-----	-----	4	----	1	5.08	2.54	12.25	7.00	2.96
	87914-0431	-----	-----	-----	-----	4	----	1	5.08	2.54	13.38	6.09	5.00
	87914-0412	-----	-----	-----	-----	4	----	2	5.08	2.54	10.92	5.84	2.79
	87914-0422	-----	-----	-----	-----	4	----	2	5.08	2.54	12.25	7.00	2.96
	87914-0432	-----	-----	-----	-----	4	----	2	5.08	2.54	13.38	6.09	5.00
E	87914-0413	-----	-----	-----	-----	4	----	3	5.08	2.54	10.92	5.84	2.79
	87914-0423	-----	-----	-----	-----	4	----	3	5.08	2.54	12.25	7.00	2.96
	87914-0433	-----	-----	-----	-----	4	----	3	5.08	2.54	13.38	6.09	5.00
	87914-0414	-----	-----	-----	-----	4	----	4	5.08	2.54	10.92	5.84	2.79
	87914-0424	-----	-----	-----	-----	4	----	4	5.08	2.54	12.25	7.00	2.96
	87914-0434	-----	-----	-----	-----	4	----	4	5.08	2.54	13.38	6.09	5.00
D	87914-0415	-----	-----	-----	-----	4	----	5	5.08	2.54	10.92	5.84	2.79
	87914-0425	-----	-----	-----	-----	4	----	5	5.08	2.54	12.25	7.00	2.96
	87914-0435	-----	-----	-----	-----	4	----	5	5.08	2.54	13.38	6.09	5.00
	87914-0416	-----	-----	-----	-----	4	----	6	5.08	2.54	10.92	5.84	2.79
	87914-0426	-----	-----	-----	-----	4	----	6	5.08	2.54	12.25	7.00	2.96
	87914-0436	-----	-----	-----	-----	4	----	6	5.08	2.54	13.38	6.09	5.00
C													
B													

PG8. +879140108 EC NO: S2010-0695 DRWN:ATSEE 2010/02/11 CHKD:PTLIM 2004/12/08 APPR:MLONG 2010/06/05 D7	QUALITY SYMBOLS $\nabla_A=0$ $\nabla_C=0$ $\nabla_P=0$	GENERAL TOLERANCES (UNLESS SPECIFIED) <table border="1"> <tr><th colspan="2">mm</th><th>INCH</th></tr> <tr><td>4 PLACES</td><td>± ---</td><td>± ---</td></tr> <tr><td>3 PLACES</td><td>± ---</td><td>± ---</td></tr> <tr><td>2 PLACES</td><td>± 0.20</td><td>± ---</td></tr> <tr><td>1 PLACE</td><td>± ---</td><td>± ---</td></tr> </table>	mm		INCH	4 PLACES	± ---	± ---	3 PLACES	± ---	± ---	2 PLACES	± 0.20	± ---	1 PLACE	± ---	± ---	DIMENSION STYLE MM ONLY	SCALE NTS	DESIGN UNITS METRIC		TITLE 2.54MM PITCH DUAL ROW HEADER SINGLE WAFER, T/H
	mm		INCH																			
	4 PLACES	± ---	± ---																			
	3 PLACES	± ---	± ---																			
2 PLACES	± 0.20	± ---																				
1 PLACE	± ---	± ---																				
DESCRIPTION DRAWN BY: KCHO CHECKED BY: PTLIM APPROVED BY: SCLOW	DATE 2004/11/05 2004/12/08 2004/12/10	MATERIAL NO. SEE TABLE	DOCUMENT NO. SD-87914-013	SHEET NO. 4 OF 46																		
DRAFT WHERE APPLICABLE MUST REMAIN WITHIN DIMENSIONS		SIZE A3	THIS DRAWING CONTAINS INFORMATION THAT IS PROPRIETARY TO MOLEX INCORPORATED AND SHOULD NOT BE USED WITHOUT WRITTEN PERMISSION																			
								MOLEX INCORPORATED														

PART NO FOR TRAY PACKAGING	PART NO. FOR TUBE WITHOUT CAP PACKAGING	PART NO. FOR TUBE WITH CAP PACKAGING	PART NO. FOR TAPE & REEL WITHOUT CAP PACKAGING	PART NO. FOR TAPE & REEL WITH CAP PACKAGING	CKT SIZE	VOID POSITION	PLATING TYPE	DIMENSION					
								A	B	F	M	P	G
87914-0611	-----	-----	-----	-----	6	----	1	7.62	5.08	10.92	5.84	2.79	----
87914-0621	-----	-----	-----	-----	6	----	1	7.62	5.08	12.25	7.00	2.96	----
87914-0631	-----	-----	-----	-----	6	----	1	7.62	5.08	13.38	6.09	5.00	----
87914-0612	-----	-----	-----	-----	6	----	2	7.62	5.08	10.92	5.84	2.79	----
87914-0622	-----	-----	-----	-----	6	----	2	7.62	5.08	12.25	7.00	2.96	----
87914-0632	-----	-----	-----	-----	6	----	2	7.62	5.08	13.38	6.09	5.00	----
87914-0613	-----	-----	-----	-----	6	----	3	7.62	5.08	10.92	5.84	2.79	----
87914-0623	-----	-----	-----	-----	6	----	3	7.62	5.08	12.25	7.00	2.96	----
87914-0633	-----	-----	-----	-----	6	----	3	7.62	5.08	13.38	6.09	5.00	----
87914-0614	-----	-----	-----	-----	6	----	4	7.62	5.08	10.92	5.84	2.79	----
87914-0624	-----	-----	-----	-----	6	----	4	7.62	5.08	12.25	7.00	2.96	----
87914-0634	-----	-----	-----	-----	6	----	4	7.62	5.08	13.38	6.09	5.00	----
87914-0615	-----	-----	-----	-----	6	----	5	7.62	5.08	10.92	5.84	2.79	----
87914-0625	-----	-----	-----	-----	6	----	5	7.62	5.08	12.25	7.00	2.96	----
87914-0635	-----	-----	-----	-----	6	----	5	7.62	5.08	13.38	6.09	5.00	----
87914-0616	-----	-----	-----	-----	6	----	6	7.62	5.08	10.92	5.84	2.79	----
87914-0626	-----	-----	-----	-----	6	----	6	7.62	5.08	12.25	7.00	2.96	----
87914-0636	-----	-----	-----	-----	6	----	6	7.62	5.08	13.38	6.09	5.00	----
-----	-----	-----	-----	87914-0627	6	----	6	7.62	5.08	13.55	8.08	3.18	14.70

<p>PG8. +879140108 EC NO: S2010-0695 DRWN:ATSEE 2010/02/11 CHKD:PTLIM 2004/12/08 APPR:MLONG 2010/06/05</p>										QUALITY SYMBOLS $F_A=0$ $F_G=0$ $F_P=0$	GENERAL TOLERANCES (UNLESS SPECIFIED) mm INCH 4 PLACES \pm --- \pm --- 3 PLACES \pm --- \pm --- 2 PLACES \pm 0.20 \pm --- 1 PLACE \pm --- \pm --- ANGULAR \pm 3 °	DIMENSION STYLE MM ONLY DRAWN BY DATE KCHO 2004/11/05 CHECKED BY DATE PTLIM 2004/12/08 APPROVED BY DATE SCLOW 2004/12/10	SCALE NTS DESIGN UNITS METRIC THIRD ANGLE PROJECTION	TITLE 2.54MM PITCH DUAL ROW HEADER SINGLE WAFER, T/H				MATERIAL NO. SEE TABLE	DOCUMENT NO. SD-87914-013	SHEET NO. 5 OF 46
--	--	--	--	--	--	--	--	--	--	--	---	--	--	--	--	--	--	----------------------------------	-------------------------------------	-----------------------------

DRAFT WHERE APPLICABLE MUST REMAIN WITHIN DIMENSIONS THIS DRAWING CONTAINS INFORMATION THAT IS PROPRIETARY TO MOLEX INCORPORATED AND SHOULD NOT BE USED WITHOUT WRITTEN PERMISSION									
---	--	--	--	--	--	--	--	--	--

PART NO FOR TRAY PACKAGING	PART NO. FOR TUBE WITHOUT CAP PACKAGING	PART NO. FOR TUBE WITH CAP PACKAGING	PART NO. FOR TAPE & REEL WITHOUT CAP PACKAGING	PART NO. FOR TAPE & REEL WITH CAP PACKAGING	CKT SIZE	VOID POSITION	PLATING TYPE	DIMENSION				
								A	B	F	M	P
87914-0009	-----	-----	-----	-----	6	-----	1	7.62	5.08	18.84	13.25	3.30
87914-0642	-----	-----	-----	-----	6	-----	2	7.62	5.08	18.84	13.25	3.30
87914-0643	-----	-----	-----	-----	6	-----	3	7.62	5.08	18.84	13.25	3.30
87914-0644	-----	-----	-----	-----	6	-----	4	7.62	5.08	18.84	13.25	3.30
87914-0645	-----	-----	-----	-----	6	-----	5	7.62	5.08	18.84	13.25	3.30
87914-0646	-----	-----	-----	-----	6	-----	6	7.62	5.08	18.84	13.25	3.30

PG8. +879140108 EC NO: S2010-0695 DRW:ATSEE 2010/02/11 CHKD:PTLIM 2004/12/08 APPR:MLONG 2010/06/05	QUALITY SYMBOLS $F_A=0$ $F_C=0$ $F_P=0$	GENERAL TOLERANCES (UNLESS SPECIFIED) mm INCH		DIMENSION STYLE MM ONLY		SCALE NTS	DESIGN UNITS METRIC	THIRD ANGLE PROJECTION		
		4 PLACES ± --- ± --- 3 PLACES ± --- ± --- 2 PLACES ± 0.20 ± --- 1 PLACE ± --- ± --- ANGULAR ± 3 °	DRAWN BY KCHO CHECKED BY PTLIM APPROVED BY SCLOW	DATE 2004/11/05 DATE 2004/12/08 DATE 2004/12/10	TITLE 2.54MM PITCH DUAL ROW HEADER SINGLE WAFER, T/H MOLEX INCORPORATED			MATERIAL NO. SEE TABLE	DOCUMENT NO. SD-87914-013	SHEET NO. 6 OF 46
D7		DRAFT WHERE APPLICABLE MUST REMAIN WITHIN DIMENSIONS		SIZE A3		THIS DRAWING CONTAINS INFORMATION THAT IS PROPRIETARY TO MOLEX INCORPORATED AND SHOULD NOT BE USED WITHOUT WRITTEN PERMISSION				

	10	9	8	7	6	5	4	3	2	1				
	PART NO. FOR TRAY PACKAGING	PART NO. FOR TUBE WITHOUT CAP PACKAGING	PART NO. FOR TUBE WITH CAP PACKAGING	PART NO. FOR TAPE & REEL WITHOUT CAP PACKAGING	PART NO. FOR TAPE & REEL WITH CAP PACKAGING	CKT SIZE	VOID POSITION	PLATING TYPE	DIMENSION					
									A	B	F	M	P	G
F	87914-0811	-----	-----	-----	-----	8	-----	1	10.16	7.62	10.92	5.84	2.79	----
	87914-0821	-----	-----	-----	-----	8	-----	1	10.16	7.62	12.25	7.00	2.96	----
	87914-0831	-----	-----	-----	-----	8	-----	1	10.16	7.62	13.38	6.09	5.00	----
	87914-0812	-----	-----	-----	-----	8	-----	2	10.16	7.62	10.92	5.84	2.79	----
	87914-0822	-----	-----	-----	-----	8	-----	2	10.16	7.62	12.25	7.00	2.96	----
	87914-0832	-----	-----	-----	-----	8	-----	2	10.16	7.62	13.38	6.09	5.00	----
E	87914-0813	-----	-----	-----	-----	8	-----	3	10.16	7.62	10.92	5.84	2.79	----
	87914-0823	-----	-----	-----	-----	8	-----	3	10.16	7.62	12.25	7.00	2.96	----
	87914-0833	-----	-----	-----	-----	8	-----	4	10.16	7.62	13.38	6.09	5.00	----
	87914-0814	-----	-----	-----	-----	8	-----	4	10.16	7.62	10.92	5.84	2.79	----
	87914-0824	-----	-----	-----	-----	8	-----	4	10.16	7.62	12.25	7.00	2.96	----
	87914-0834	-----	-----	-----	-----	8	-----	4	10.16	7.62	13.38	6.09	5.00	----
D	87914-0815	-----	-----	-----	-----	8	-----	5	10.16	7.62	10.92	5.84	2.79	----
	87914-0825	-----	-----	-----	-----	8	-----	5	10.16	7.62	12.25	7.00	2.96	----
	87914-0835	-----	-----	-----	-----	8	-----	5	10.16	7.62	13.38	6.09	5.00	----
	87914-0816	-----	-----	-----	-----	8	-----	6	10.16	7.62	10.92	5.84	2.79	----
	87914-0826	-----	-----	-----	-----	8	-----	6	10.16	7.62	12.25	7.00	2.96	----
	87914-0836	-----	-----	-----	-----	8	-----	6	10.16	7.62	13.38	6.09	5.00	----
C	87914-0807	-----	-----	-----	-----	8	2,3,4,5,6,8	6	10.16	7.62	21.75	16.51	2.95	----
	-----	-----	-----	-----	87914-0827	8	-----	6	10.16	7.62	13.55	8.08	3.18	14.70

B

PG8. +879140108 EC NO: S2010-0695 DRWN:ATSEE 2010/02/11 CHKD:PTLIM 2004/12/08 APPR:MLONG 2010/06/05	REV	D7	DESCRIPTION	QUALITY SYMBOLS	$\nabla_A = 0$ $\nabla_C = 0$ $\nabla_P = 0$	GENERAL TOLERANCES (UNLESS SPECIFIED) <table border="1" style="width: 100%; border-collapse: collapse;"> <tr> <th></th> <th>mm</th> <th>INCH</th> </tr> <tr> <td>4 PLACES</td> <td>± ---</td> <td>± ---</td> </tr> <tr> <td>3 PLACES</td> <td>± ---</td> <td>± ---</td> </tr> <tr> <td>2 PLACES</td> <td>± 0.20</td> <td>± ---</td> </tr> <tr> <td>1 PLACE</td> <td>± ---</td> <td>± ---</td> </tr> </table>		mm	INCH	4 PLACES	± ---	± ---	3 PLACES	± ---	± ---	2 PLACES	± 0.20	± ---	1 PLACE	± ---	± ---	DIMENSION STYLE MM ONLY	SCALE NTS	DESIGN UNITS METRIC	THIRD ANGLE PROJECTION
		mm	INCH																						
	4 PLACES	± ---	± ---																						
	3 PLACES	± ---	± ---																						
2 PLACES	± 0.20	± ---																							
1 PLACE	± ---	± ---																							
					DRAWN BY: KCHO CHECKED BY: PTLIM APPROVED BY: SCLOW	DATE: 2004/11/05 DATE: 2004/12/08 DATE: 2004/12/10	2.54MM PITCH DUAL ROW HEADER SINGLE WAFER, T/H																		
					ANGULAR ± 3 °	MOLEX INCORPORATED																			
					DRAFT WHERE APPLICABLE MUST REMAIN WITHIN DIMENSIONS	SEE TABLE	DOCUMENT NO. SD-87914-013		SHEET NO. 7 OF 46																

F	PART NO FOR TRAY PACKAGING	PART NO. FOR TUBE WITHOUT CAP PACKAGING	PART NO. FOR TUBE WITH CAP PACKAGING	PART NO. FOR TAPE & REEL WITHOUT CAP PACKAGING	PART NO. FOR TAPE & REEL WITH CAP PACKAGING	CKT SIZE	VOID POSITION	PLATING TYPE	DIMENSION				
									A	B	F	M	P
									87914-0841	-----	-----	-----	-----
87914-0842	-----	-----	-----	-----	8	----	2	10.16	7.62	13.51	8.75	2.47	
87914-0843	-----	-----	-----	-----	8	----	3	10.16	7.62	13.51	8.75	2.47	
87914-0844	-----	-----	-----	-----	8	----	4	10.16	7.62	13.51	8.75	2.47	
87914-0845	-----	-----	-----	-----	8	----	5	10.16	7.62	13.51	8.75	2.47	
87914-0005	-----	-----	-----	-----	8	----	6	10.16	7.62	13.51	8.75	2.47	
E	87914-0108	-----	-----	-----	-----	8	----	6	10.16	7.62	16.50	11.11	3.10

PG8. +879140108 EC NO: S2010-0695 DRWN:ATSEE 2010/02/11 CHKD:PTLIM 2004/12/08 APPR:MLONG 2010/06/05	QUALITY SYMBOLS	GENERAL TOLERANCES (UNLESS SPECIFIED)	DIMENSION STYLE	SCALE	DESIGN UNITS	THIRD ANGLE PROJECTION
	$\nabla_A = 0$	\pm mm \pm INCH	MM ONLY	NTS	METRIC	
	$\nabla_C = 0$ $\nabla_P = 0$	4 PLACES \pm --- \pm --- 3 PLACES \pm --- \pm --- 2 PLACES \pm 0.20 \pm --- 1 PLACE \pm --- \pm --- ANGULAR \pm 3 °	DRAWN BY: KCHO DATE: 2004/11/05 CHECKED BY: PTLIM DATE: 2004/12/08 APPROVED BY: SCLOW DATE: 2004/12/10	TITLE: 2.54MM PITCH DUAL ROW HEADER SINGLE WAFER, T/H		
D7	DRAFT WHERE APPLICABLE MUST REMAIN WITHIN DIMENSIONS	SEE TABLE	MATERIAL NO. DOCUMENT NO.		MOLEX INCORPORATED	
		SIZE: A3	THIS DRAWING CONTAINS INFORMATION THAT IS PROPRIETARY TO MOLEX INCORPORATED AND SHOULD NOT BE USED WITHOUT WRITTEN PERMISSION			SHEET NO. 8 OF 46

10		9		8		7		6		5		4		3		2		1	
PART NO FOR TRAY PACKAGING	PART NO. FOR TUBE WITHOUT CAP PACKAGING	PART NO. FOR TUBE WITH CAP PACKAGING	PART NO. FOR TAPE & REEL WITHOUT CAP PACKAGING	PART NO. FOR TAPE & REEL WITH CAP PACKAGING	PART NO. FOR BULK PACKAGING	CKT SIZE	VOID POSITION	PLATING TYPE	DIMENSION										
									A	B	F	M	P	G					
F	87914-1011	-----	-----	-----	-----	10	----	1	12.70	10.16	10.92	5.84	2.79	----					
	87914-1021	-----	-----	-----	-----	10	----	1	12.70	10.16	12.25	7.00	2.96	----					
	87914-1031	-----	-----	-----	-----	10	----	1	12.70	10.16	13.38	6.09	5.00	----					
	87914-1012	-----	-----	-----	-----	10	----	2	12.70	10.16	10.92	5.84	2.79	----					
	87914-1022	-----	-----	-----	-----	10	----	2	12.70	10.16	12.25	7.00	2.96	----					
	87914-1032	-----	-----	-----	-----	10	----	2	12.70	10.16	13.38	6.09	5.00	----					
E	87914-1013	-----	-----	-----	-----	10	----	3	12.70	10.16	10.92	5.84	2.79	----					
	87914-1023	-----	-----	-----	-----	10	----	3	12.70	10.16	12.25	7.00	2.96	----					
	87914-1033	-----	-----	-----	-----	10	----	3	12.70	10.16	13.38	6.09	5.00	----					
	87914-1014	-----	-----	-----	-----	10	----	4	12.70	10.16	10.92	5.84	2.79	----					
	87914-1024	-----	-----	-----	-----	10	----	4	12.70	10.16	12.25	7.00	2.96	----					
	87914-1034	-----	-----	-----	-----	10	----	4	12.70	10.16	13.38	6.09	5.00	----					
D	87914-1015	-----	-----	-----	-----	10	----	5	12.70	10.16	10.92	5.84	2.79	----					
	87914-1025	-----	-----	-----	-----	10	----	5	12.70	10.16	12.25	7.00	2.96	----					
	87914-1035	-----	-----	-----	-----	10	----	5	12.70	10.16	13.38	6.09	5.00	----					
	87914-1016	-----	-----	-----	-----	10	----	6	12.70	10.16	10.92	5.84	2.79	----					
	87914-1026	-----	-----	-----	-----	10	----	6	12.70	10.16	12.25	7.00	2.96	----					
	87914-1036	-----	-----	-----	-----	10	----	6	12.70	10.16	13.38	6.09	5.00	----					
C	87914-0001	-----	-----	-----	-----	10	----	7	12.70	10.16	12.07	5.97	3.81	----					
	-----	-----	-----	-----	87914-1037	10	9	4	12.70	10.16	10.92	5.84	2.79	----					
B																			

PG8, +879140108 EC NO: S2010-0695 DRW:ATSEE 2010/02/11 CHKD:PTLIM 2004/12/08 APPR:MLONG 2010/06/05	QUALITY SYMBOLS $F_A=0$ $F_G=0$ $F_P=0$	GENERAL TOLERANCES (UNLESS SPECIFIED) <table border="1"> <tr><th colspan="2">mm</th><th>INCH</th></tr> <tr><td>4 PLACES</td><td>± ---</td><td>± ---</td></tr> <tr><td>3 PLACES</td><td>± ---</td><td>± ---</td></tr> <tr><td>2 PLACES</td><td>± 0.20</td><td>± ---</td></tr> <tr><td>1 PLACE</td><td>± ---</td><td>± ---</td></tr> </table>	mm		INCH	4 PLACES	± ---	± ---	3 PLACES	± ---	± ---	2 PLACES	± 0.20	± ---	1 PLACE	± ---	± ---	DIMENSION STYLE MM ONLY DRAWN BY: KCHO DATE: 2004/11/05 CHECKED BY: PTLIM DATE: 2004/12/08 APPROVED BY: SCLOW DATE: 2004/12/10	SCALE: NTS DESIGN UNITS: METRIC THIRD ANGLE PROJECTION	TITLE: 2.54MM PITCH DUAL ROW HEADER SINGLE WAFER, T/H MOLEX INCORPORATED
	mm		INCH																	
	4 PLACES	± ---	± ---																	
	3 PLACES	± ---	± ---																	
2 PLACES	± 0.20	± ---																		
1 PLACE	± ---	± ---																		
DRAFT WHERE APPLICABLE MUST REMAIN WITHIN DIMENSIONS	SEE TABLE	MATERIAL NO.: SD-87914-013	SHEET NO.: 9 OF 46																	
THIS DRAWING CONTAINS INFORMATION THAT IS PROPRIETARY TO MOLEX INCORPORATED AND SHOULD NOT BE USED WITHOUT WRITTEN PERMISSION																				
SIZE: A3																				

	10	9	8	7	6	5	4	3	2	1			
	PART NO FOR TRAY PACKAGING	PART NO. FOR TUBE WITHOUT CAP PACKAGING	PART NO. FOR TUBE WITH CAP PACKAGING	PART NO. FOR TAPE & REEL WITHOUT CAP PACKAGING	PART NO. FOR TAPE & REEL WITH CAP PACKAGING	CKT SIZE	VOID POSITION	PLATING TYPE	DIMENSION				
								A	B	F	M	P	
F	87914-1211	-----	-----	-----	-----	12	----	1	15.24	12.70	10.92	5.84	2.79
	87914-1221	-----	-----	-----	-----	12	----	1	15.24	12.70	12.25	7.00	2.96
	87914-1231	-----	-----	-----	-----	12	----	1	15.24	12.70	13.38	6.09	5.00
	87914-1212	-----	-----	-----	-----	12	----	2	15.24	12.70	10.92	5.84	2.79
	87914-1222	-----	-----	-----	-----	12	----	2	15.24	12.70	12.25	7.00	2.96
	87914-1232	-----	-----	-----	-----	12	----	2	15.24	12.70	13.38	6.09	5.00
E	87914-1213	-----	-----	-----	-----	12	----	3	15.24	12.70	10.92	5.84	2.79
	87914-1223	-----	-----	-----	-----	12	----	3	15.24	12.70	12.25	7.00	2.96
	87914-1233	-----	-----	-----	-----	12	----	3	15.24	12.70	13.38	6.09	5.00
	87914-1214	-----	-----	-----	-----	12	----	4	15.24	12.70	10.92	5.84	2.79
	87914-1224	-----	-----	-----	-----	12	----	4	15.24	12.70	12.25	7.00	2.96
	87914-1234	-----	-----	-----	-----	12	----	4	15.24	12.70	13.38	6.09	5.00
D	87914-1215	-----	-----	-----	-----	12	----	5	15.24	12.70	10.92	5.84	2.79
	87914-1225	-----	-----	-----	-----	12	----	5	15.24	12.70	12.25	7.00	2.96
	87914-1235	-----	-----	-----	-----	12	----	5	15.24	12.70	13.38	6.09	5.00
	87914-1216	-----	-----	-----	-----	12	----	6	15.24	12.70	10.92	5.84	2.79
	87914-1226	-----	-----	-----	-----	12	----	6	15.24	12.70	12.25	7.00	2.96
	87914-1236	-----	-----	-----	-----	12	----	6	15.24	12.70	13.38	6.09	5.00

C

B

PG8. +879140108 EC NO: S2010-0695 DRWN:ATSEE 2010/02/11 CHKD:PTLIM 2004/12/08 APPR:MLONG 2010/06/05	QUALITY SYMBOLS	GENERAL TOLERANCES (UNLESS SPECIFIED)	DIMENSION STYLE	SCALE	DESIGN UNITS	THIRD ANGLE PROJECTION																						
	$\nabla_A = 0$ $\nabla_C = 0$ $\nabla_P = 0$	<table border="1"> <tr> <th></th> <th>mm</th> <th>INCH</th> </tr> <tr> <td>4 PLACES</td> <td>± ---</td> <td>± ---</td> </tr> <tr> <td>3 PLACES</td> <td>± ---</td> <td>± ---</td> </tr> <tr> <td>2 PLACES</td> <td>± 0.20</td> <td>± ---</td> </tr> <tr> <td>1 PLACE</td> <td>± ---</td> <td>± ---</td> </tr> </table>		mm	INCH	4 PLACES	± ---	± ---	3 PLACES	± ---	± ---	2 PLACES	± 0.20	± ---	1 PLACE	± ---	± ---	MM ONLY	NTS	METRIC								
		mm	INCH																									
	4 PLACES	± ---	± ---																									
3 PLACES	± ---	± ---																										
2 PLACES	± 0.20	± ---																										
1 PLACE	± ---	± ---																										
DESCRIPTION	<table border="1"> <tr> <th>REV</th> <th>DESCRIPTION</th> </tr> <tr> <td>D7</td> <td></td> </tr> </table>	REV	DESCRIPTION	D7		<table border="1"> <tr> <th>DRAWN BY</th> <th>DATE</th> <th>TITLE</th> </tr> <tr> <td>KCHO</td> <td>2004/11/05</td> <td rowspan="3">2.54MM PITCH DUAL ROW HEADER SINGLE WAFER, T/H</td> </tr> <tr> <th>CHECKED BY</th> <th>DATE</th> </tr> <tr> <td>PTLIM</td> <td>2004/12/08</td> </tr> <tr> <th>APPROVED BY</th> <th>DATE</th> <td rowspan="2"> MOLEX INCORPORATED </td> </tr> <tr> <td>SCLOW</td> <td>2004/12/10</td> </tr> </table>	DRAWN BY	DATE	TITLE	KCHO	2004/11/05	2.54MM PITCH DUAL ROW HEADER SINGLE WAFER, T/H	CHECKED BY	DATE	PTLIM	2004/12/08	APPROVED BY	DATE	MOLEX INCORPORATED	SCLOW	2004/12/10	<table border="1"> <tr> <th>MATERIAL NO.</th> <th>DOCUMENT NO.</th> <th>SHEET NO.</th> </tr> <tr> <td>SEE TABLE</td> <td>SD-87914-013</td> <td>10 OF 46</td> </tr> </table>	MATERIAL NO.	DOCUMENT NO.	SHEET NO.	SEE TABLE	SD-87914-013	10 OF 46
REV	DESCRIPTION																											
D7																												
DRAWN BY	DATE	TITLE																										
KCHO	2004/11/05	2.54MM PITCH DUAL ROW HEADER SINGLE WAFER, T/H																										
CHECKED BY	DATE																											
PTLIM	2004/12/08																											
APPROVED BY	DATE	MOLEX INCORPORATED																										
SCLOW	2004/12/10																											
MATERIAL NO.	DOCUMENT NO.	SHEET NO.																										
SEE TABLE	SD-87914-013	10 OF 46																										
	DRAFT WHERE APPLICABLE MUST REMAIN WITHIN DIMENSIONS	<table border="1"> <tr> <th>SIZE</th> <th>THIS DRAWING CONTAINS INFORMATION THAT IS PROPRIETARY TO MOLEX INCORPORATED AND SHOULD NOT BE USED WITHOUT WRITTEN PERMISSION</th> </tr> <tr> <td>A3</td> <td></td> </tr> </table>	SIZE	THIS DRAWING CONTAINS INFORMATION THAT IS PROPRIETARY TO MOLEX INCORPORATED AND SHOULD NOT BE USED WITHOUT WRITTEN PERMISSION	A3																							
SIZE	THIS DRAWING CONTAINS INFORMATION THAT IS PROPRIETARY TO MOLEX INCORPORATED AND SHOULD NOT BE USED WITHOUT WRITTEN PERMISSION																											
A3																												

10		9		8		7		6		5			4		3		2		1	
PART NO FOR TRAY PACKAGING	PART NO. FOR TUBE WITHOUT CAP PACKAGING	PART NO. FOR TUBE WITH CAP PACKAGING	PART NO. FOR TAPE & REEL WITHOUT CAP PACKAGING	PART NO. FOR TAPE & REEL WITH CAP PACKAGING	CKT SIZE	VOID POSITION	PLATING TYPE	DIMENSION												
								A	B	F	M	P								
F	87914-1251	-----	-----	-----	-----	12	----	1	15.24	12.70	18.40	13.08	3.03							
	87914-1252	-----	-----	-----	-----	12	----	2	15.24	12.70	18.40	13.08	3.03							
	87914-1253	-----	-----	-----	-----	12	----	3	15.24	12.70	18.40	13.08	3.03							
	87914-1254	-----	-----	-----	-----	12	----	4	15.24	12.70	18.40	13.08	3.03							
	87914-1255	-----	-----	-----	-----	12	----	5	15.24	12.70	18.40	13.08	3.03							
	87914-1256	-----	-----	-----	-----	12	----	6	15.24	12.70	18.40	13.08	3.03							
E	87914-1241	-----	-----	-----	-----	12	----	1	15.24	12.70	12.50	6.95	3.26							
	87914-1242	-----	-----	-----	-----	12	----	2	15.24	12.70	12.50	6.95	3.26							
	87914-1243	-----	-----	-----	-----	12	----	3	15.24	12.70	12.50	6.95	3.26							
	87914-1244	-----	-----	-----	-----	12	----	4	15.24	12.70	12.50	6.95	3.26							
	87914-1245	-----	-----	-----	-----	12	----	5	15.24	12.70	12.50	6.95	3.26							
D																				
C																				
B																				

PG8. +879140108 EC NO: S2010-0695 DRW:ATSEE 2010/02/11 CHKD:PTLIM 2004/12/08 APPR:MLONG 2010/06/05 D7	QUALITY SYMBOLS $\nabla_A=0$ $\nabla_C=0$ $\nabla_P=0$	GENERAL TOLERANCES (UNLESS SPECIFIED) <table border="1"> <tr><td></td><td>mm</td><td>INCH</td></tr> <tr><td>4 PLACES</td><td>± ---</td><td>± ---</td></tr> <tr><td>3 PLACES</td><td>± ---</td><td>± ---</td></tr> <tr><td>2 PLACES</td><td>± 0.20</td><td>± ---</td></tr> <tr><td>1 PLACE</td><td>± ---</td><td>± ---</td></tr> </table>		mm	INCH	4 PLACES	± ---	± ---	3 PLACES	± ---	± ---	2 PLACES	± 0.20	± ---	1 PLACE	± ---	± ---	DIMENSION STYLE MM ONLY DRAWN BY: KCHO CHECKED BY: PTLIM APPROVED BY: SCLOW DATE: 2004/11/05 DATE: 2004/12/08 DATE: 2004/12/10	SCALE NTS	DESIGN UNITS METRIC	THIRD ANGLE PROJECTION	TITLE 2.54MM PITCH DUAL ROW HEADER SINGLE WAFER, T/H	MATERIAL NO. SEE TABLE	DOCUMENT NO. SD-87914-013	SHEET NO. 11 OF 46
		mm	INCH																						
4 PLACES	± ---	± ---																							
3 PLACES	± ---	± ---																							
2 PLACES	± 0.20	± ---																							
1 PLACE	± ---	± ---																							
DRAFT WHERE APPLICABLE MUST REMAIN WITHIN DIMENSIONS		THIS DRAWING CONTAINS INFORMATION THAT IS PROPRIETARY TO MOLEX INCORPORATED AND SHOULD NOT BE USED WITHOUT WRITTEN PERMISSION																							

PART NO FOR TRAY PACKAGING	PART NO. FOR TUBE WITHOUT CAP PACKAGING	PART NO. FOR TUBE WITH CAP PACKAGING	PART NO. FOR TAPE & REEL WITHOUT CAP PACKAGING	PART NO. FOR TAPE & REEL WITH CAP PACKAGING	CKT SIZE	VOID POSITION	PLATING TYPE	DIMENSION				
								A	B	F	M	P
								F	87914-1411	-----	-----	-----
	87914-1421	-----	-----	-----	14	-----	1	17.78	15.24	12.25	7.00	2.96
	87914-1431	-----	-----	-----	14	-----	1	17.78	15.24	13.38	6.09	5.00
	87914-1412	-----	-----	-----	14	-----	2	17.78	15.24	10.92	5.84	2.79
	87914-1422	-----	-----	-----	14	-----	2	17.78	15.24	12.25	7.00	2.96
	87914-1432	-----	-----	-----	14	-----	2	17.78	15.24	13.38	6.09	5.00
E	87914-1413	-----	-----	-----	14	-----	3	17.78	15.24	10.92	5.84	2.79
	87914-1423	-----	-----	-----	14	-----	3	17.78	15.24	12.25	7.00	2.96
	87914-1433	-----	-----	-----	14	-----	3	17.78	15.24	13.38	6.09	5.00
	87914-1414	-----	-----	-----	14	-----	4	17.78	15.24	10.92	5.84	2.79
	87914-1424	-----	-----	-----	14	-----	4	17.78	15.24	12.25	7.00	2.96
	87914-1434	-----	-----	-----	14	-----	4	17.78	15.24	13.38	6.09	5.00
D	87914-1415	-----	-----	-----	14	-----	5	17.78	15.24	10.92	5.84	2.79
	87914-1425	-----	-----	-----	14	-----	5	17.78	15.24	12.25	7.00	2.96
	87914-1435	-----	-----	-----	14	-----	5	17.78	15.24	13.38	6.09	5.00
	87914-1416	-----	-----	-----	14	-----	6	17.78	15.24	10.92	5.84	2.79
	87914-1426	-----	-----	-----	14	-----	6	17.78	15.24	12.25	7.00	2.96
	87914-1436	-----	-----	-----	14	-----	6	17.78	15.24	13.38	6.09	5.00
C	87914-0007	-----	-----	-----	14	-----	6	17.78	15.24	13.42	8.08	3.05

PG8. +879140108 EC NO: S2010-0695 DRWN:ATSEE 2010/02/11 CHKD:PTLIM 2004/12/08 APPR:MLONG 2010/06/05 REV D7	QUALITY SYMBOLS	GENERAL TOLERANCES (UNLESS SPECIFIED)	DIMENSION STYLE	SCALE	DESIGN UNITS	THIRD ANGLE PROJECTION
	$\nabla_A = 0$ $\nabla_C = 0$ $\nabla_P = 0$	mm INCH 4 PLACES ± --- ± --- 3 PLACES ± --- ± --- 2 PLACES ± 0.20 ± --- 1 PLACE ± --- ± --- ANGULAR ± 3 °	MM ONLY	NTS	METRIC	
	DESCRIPTION	DRAFT WHERE APPLICABLE MUST REMAIN WITHIN DIMENSIONS	DRAWN BY DATE KCHO 2004/11/05 CHECKED BY DATE PTLIM 2004/12/08 APPROVED BY DATE SCLOW 2004/12/10	TITLE	2.54MM PITCH DUAL ROW HEADER SINGLE WAFER, T/H MOLEX INCORPORATED	
			SEE TABLE	MATERIAL NO.	DOCUMENT NO.	SHEET NO.

10		9		8		7		6		5		4		3		2		1	
PART NO FOR TRAY PACKAGING	PART NO. FOR TUBE WITHOUT CAP PACKAGING	PART NO. FOR TUBE WITH CAP PACKAGING	PART NO. FOR TAPE & REEL WITHOUT CAP PACKAGING	PART NO. FOR TAPE & REEL WITH CAP PACKAGING	CKT SIZE	VOID POSITION	PLATING TYPE	DIMENSION											
								A	B	F	M	P							
87914-1441	-----	-----	-----	-----	14	----	1	17.78	15.24	13.42	8.08	3.05							
87914-1442	-----	-----	-----	-----	14	----	2	17.78	15.24	13.42	8.08	3.05							
87914-1443	-----	-----	-----	-----	14	----	3	17.78	15.24	13.42	8.08	3.05							
87914-1444	-----	-----	-----	-----	14	----	4	17.78	15.24	13.42	8.08	3.05							
87914-1445	-----	-----	-----	-----	14	----	5	17.78	15.24	13.42	8.08	3.05							

PG8. +879140108 EC NO: S2010-0695 DRW:ATSEE 2010/02/11 CHK:PTLIM 2004/12/08 APPR:MLONG 2010/06/05	QUALITY SYMBOLS	GENERAL TOLERANCES (UNLESS SPECIFIED)		DIMENSION STYLE		SCALE	DESIGN UNITS	THIRD ANGLE PROJECTION	
	$\nabla_A = 0$	mm INCH		MM ONLY		NTS	METRIC		
	$\nabla_C = 0$	4 PLACES	\pm --- \pm ---	DRAWN BY	DATE	TITLE			
	$\nabla_P = 0$	3 PLACES	\pm --- \pm ---	KCHO	2004/11/05	2.54MM PITCH DUAL ROW HEADER SINGLE WAFER, T/H			
		2 PLACES	\pm 0.20 \pm ---	CHECKED BY	DATE				
	1 PLACE	\pm --- \pm ---	PTLIM	2004/12/08	MOLEX INCORPORATED				
	ANGULAR \pm 3 °		APPROVED BY	DATE					
	DRAFT WHERE APPLICABLE MUST REMAIN WITHIN DIMENSIONS		SCLOW	2004/12/10	MATERIAL NO.		DOCUMENT NO.	SHEET NO.	
D7			SEE TABLE			SD-87914-013		13 OF 46	
			THIS DRAWING CONTAINS INFORMATION THAT IS PROPRIETARY TO MOLEX INCORPORATED AND SHOULD NOT BE USED WITHOUT WRITTEN PERMISSION						

PART NO. FOR TRAY PACKAGING	PART NO. FOR TUBE WITHOUT CAP PACKAGING	PART NO. FOR TUBE WITH CAP PACKAGING	PART NO. FOR TAPE & REEL WITHOUT CAP PACKAGING	PART NO. FOR TAPE & REEL WITH CAP PACKAGING	CKT SIZE	VOID POSITION	PLATING TYPE	DIMENSION				
								A	B	F	M	P
								F	87914-1611	-----	-----	-----
	87914-1621	-----	-----	-----	16	-----	1	20.32	17.78	12.25	7.00	2.96
	87914-1631	-----	-----	-----	16	-----	1	20.32	17.78	13.38	6.09	5.00
	87914-1612	-----	-----	-----	16	-----	2	20.32	17.78	10.92	5.84	2.79
	87914-1622	-----	-----	-----	16	-----	2	20.32	17.78	12.25	7.00	2.96
	87914-1632	-----	-----	-----	16	-----	2	20.32	17.78	13.38	6.09	5.00
E	87914-1613	-----	-----	-----	16	-----	3	20.32	17.78	10.92	5.84	2.79
	87914-1623	-----	-----	-----	16	-----	3	20.32	17.78	12.25	7.00	2.96
	87914-1633	-----	-----	-----	16	-----	3	20.32	17.78	13.38	6.09	5.00
	87914-1614	-----	-----	-----	16	-----	4	20.32	17.78	10.92	5.84	2.79
	87914-1624	-----	-----	-----	16	-----	4	20.32	17.78	12.25	7.00	2.96
	87914-1634	-----	-----	-----	16	-----	4	20.32	17.78	13.38	6.09	5.00
D	87914-1615	-----	-----	-----	16	-----	5	20.32	17.78	10.92	5.84	2.79
	87914-1625	-----	-----	-----	16	-----	5	20.32	17.78	12.25	7.00	2.96
	87914-1635	-----	-----	-----	16	-----	5	20.32	17.78	13.38	6.09	5.00
	87914-1616	-----	-----	-----	16	-----	6	20.32	17.78	10.92	5.84	2.79
	87914-1626	-----	-----	-----	16	-----	6	20.32	17.78	12.25	7.00	2.96
	87914-1636	-----	-----	-----	16	-----	6	20.32	17.78	13.38	6.09	5.00
C	87914-1600	-----	-----	-----	16	-----	6	20.32	17.78	9.49	4.50	2.70
B												

PG8, +879140108 EC NO: S2010-0695 DRWN:ATSEE 2010/02/11 CHKD:PTLIM 2004/12/08 APPR:MLONG 2010/06/05	QUALITY SYMBOLS $F_A=0$ $F_G=0$ $F_P=0$	GENERAL TOLERANCES (UNLESS SPECIFIED)		DIMENSION STYLE	SCALE	DESIGN UNITS	THIRD ANGLE PROJECTION	
				MM ONLY	NTS	METRIC		
				DRAWN BY	DATE	TITLE		
				3 PLACES	2004/11/05	2.54MM PITCH DUAL ROW HEADER SINGLE WAFER, T/H		
		2 PLACES	2004/12/08					
		1 PLACE	2004/12/10	MOLEX INCORPORATED				
		ANGULAR $\pm 3^\circ$		MATERIAL NO.	DOCUMENT NO.			
		DRAFT WHERE APPLICABLE MUST REMAIN WITHIN DIMENSIONS		SEE TABLE	SD-87914-013		SHEET NO.	
				SIZE	THIS DRAWING CONTAINS INFORMATION THAT IS PROPRIETARY TO MOLEX INCORPORATED AND SHOULD NOT BE USED WITHOUT WRITTEN PERMISSION			

PART NO FOR TRAY PACKAGING	PART NO. FOR TUBE WITHOUT CAP PACKAGING	PART NO. FOR TUBE WITH CAP PACKAGING	PART NO. FOR TAPE & REEL WITHOUT CAP PACKAGING	PART NO. FOR TAPE & REEL WITH CAP PACKAGING	CKT SIZE	VOID POSITION	PLATING TYPE	DIMENSION				
								A	B	F	M	P
								F	87914-1811	-----	-----	-----
	87914-1821	-----	-----	-----	18	----	1	22.86	20.32	12.25	7.00	2.96
	87914-1831	-----	-----	-----	18	----	1	22.86	20.32	13.38	6.09	5.00
	87914-1812	-----	-----	-----	18	----	2	22.86	20.32	10.92	5.84	2.79
	87914-1822	-----	-----	-----	18	----	2	22.86	20.32	12.25	7.00	2.96
	87914-1832	-----	-----	-----	18	----	2	22.86	20.32	13.38	6.09	5.00
E	87914-1813	-----	-----	-----	18	----	3	22.86	20.32	10.92	5.84	2.79
	87914-1823	-----	-----	-----	18	----	3	22.86	20.32	12.25	7.00	2.96
	87914-1833	-----	-----	-----	18	----	3	22.86	20.32	13.38	6.09	5.00
	87914-1814	-----	-----	-----	18	----	4	22.86	20.32	10.92	5.84	2.79
	87914-1824	-----	-----	-----	18	----	4	22.86	20.32	12.25	7.00	2.96
	87914-1834	-----	-----	-----	18	----	4	22.86	20.32	13.38	6.09	5.00
D	87914-1815	-----	-----	-----	18	----	5	22.86	20.32	10.92	5.84	2.79
	87914-1825	-----	-----	-----	18	----	5	22.86	20.32	12.25	7.00	2.96
	87914-1835	-----	-----	-----	18	----	5	22.86	20.32	13.38	6.09	5.00
	87914-1816	-----	-----	-----	18	----	6	22.86	20.32	10.92	5.84	2.79
	87914-1826	-----	-----	-----	18	----	6	22.86	20.32	12.25	7.00	2.96
	87914-1836	-----	-----	-----	18	----	6	22.86	20.32	13.38	6.09	5.00
C												
B												

PG8. +879140108 EC NO: S2010-0695 DRWN:ATSEE 2010/02/11 CHKD:PTLIM 2004/12/08 APPR:MLONG 2010/06/05 D7	QUALITY SYMBOLS $F_A=0$ $F_C=0$ $F_P=0$	GENERAL TOLERANCES (UNLESS SPECIFIED) mm INCH		DIMENSION STYLE MM ONLY		SCALE NTS	DESIGN UNITS METRIC	THIRD ANGLE PROJECTION
		4 PLACES ± --- ± --- 3 PLACES ± --- ± --- 2 PLACES ± 0.20 ± --- 1 PLACE ± --- ± ---	DRAWN BY KCHO DATE 2004/11/05	TITLE 2.54MM PITCH DUAL ROW HEADER SINGLE WAFER, T/H				
		ANGULAR ± 3 °	CHECKED BY PTLIM DATE 2004/12/08	MOLEX INCORPORATED				
		DRAFT WHERE APPLICABLE MUST REMAIN WITHIN DIMENSIONS	APPROVED BY SCLOW DATE 2004/12/10	MATERIAL NO. SEE TABLE	DOCUMENT NO. SD-87914-013	SHEET NO. 15 OF 46		

	10	9	8	7	6	5	4	3	2	1				
	PART NO. FOR TRAY PACKAGING	PART NO. FOR TUBE WITHOUT CAP PACKAGING	PART NO. FOR TUBE WITH CAP PACKAGING	PART NO. FOR TAPE & REEL WITHOUT CAP PACKAGING	PART NO. FOR TAPE & REEL WITH CAP PACKAGING	CKT SIZE	VOID POSITION	PLATING TYPE	DIMENSION					
								A	B	F	M	P		
F	87914-2011	-----	-----	-----	-----	20	----	1	25.40	22.86	10.92	5.84	2.79	F
	87914-2021	-----	-----	-----	-----	20	----	1	25.40	22.86	12.25	7.00	2.96	
	87914-2031	-----	-----	-----	-----	20	----	1	25.40	22.86	13.38	6.09	5.00	
	87914-2012	-----	-----	-----	-----	20	----	2	25.40	22.86	10.92	5.84	2.79	
	87914-2022	-----	-----	-----	-----	20	----	2	25.40	22.86	12.25	7.00	2.96	
	87914-2032	-----	-----	-----	-----	20	----	2	25.40	22.86	13.38	6.09	5.00	
E	87914-2013	-----	-----	-----	-----	20	----	3	25.40	22.86	10.92	5.84	2.79	E
	87914-2023	-----	-----	-----	-----	20	----	3	25.40	22.86	12.25	7.00	2.96	
	87914-2033	-----	-----	-----	-----	20	----	3	25.40	22.86	13.38	6.09	5.00	
	87914-2014	-----	-----	-----	-----	20	----	4	25.40	22.86	10.92	5.84	2.79	
	87914-2024	-----	-----	-----	-----	20	----	4	25.40	22.86	12.25	7.00	2.96	
	87914-2034	-----	-----	-----	-----	20	----	4	25.40	22.86	13.38	6.09	5.00	
D	87914-2015	-----	-----	-----	-----	20	----	5	25.40	22.86	10.92	5.84	2.79	D
	87914-2025	-----	-----	-----	-----	20	----	5	25.40	22.86	12.25	7.00	2.96	
	87914-2035	-----	-----	-----	-----	20	----	5	25.40	22.86	13.38	6.09	5.00	
	87914-2016	-----	-----	-----	-----	20	----	6	25.40	22.86	10.92	5.84	2.79	
	87914-2026	-----	-----	-----	-----	20	----	6	25.40	22.86	12.25	7.00	2.96	
	87914-2036	-----	-----	-----	-----	20	----	6	25.40	22.86	13.38	6.09	5.00	
C														C
B														B

PG8. +879140108 EC NO: S2010-0695 DRWN:ATSEE 2010/02/11 CHKD:PTLIM 2004/12/08 APPR:MLONG 2010/06/05 D7	QUALITY SYMBOLS	GENERAL TOLERANCES (UNLESS SPECIFIED)	DIMENSION STYLE	SCALE	DESIGN UNITS	THIRD ANGLE PROJECTION															
	$F_A=0$ $F_G=0$ $F_P=0$	<table border="1"> <tr><th colspan="2">mm</th><th>INCH</th></tr> <tr><td>4 PLACES</td><td>± ---</td><td>± ---</td></tr> <tr><td>3 PLACES</td><td>± ---</td><td>± ---</td></tr> <tr><td>2 PLACES</td><td>± 0.20</td><td>± ---</td></tr> <tr><td>1 PLACE</td><td>± ---</td><td>± ---</td></tr> </table>	mm		INCH	4 PLACES	± ---	± ---	3 PLACES	± ---	± ---	2 PLACES	± 0.20	± ---	1 PLACE	± ---	± ---	MM ONLY	NTS	METRIC	
	mm		INCH																		
	4 PLACES	± ---	± ---																		
3 PLACES	± ---	± ---																			
2 PLACES	± 0.20	± ---																			
1 PLACE	± ---	± ---																			
DESCRIPTION	ANGULAR ± 3 °	DRAWN BY DATE	TITLE																		
	DRAFT WHERE APPLICABLE MUST REMAIN WITHIN DIMENSIONS	KCHO 2004/11/05	2.54MM PITCH DUAL ROW HEADER SINGLE WAFER, T/H																		
		CHECKED BY DATE	MOLEX INCORPORATED																		
		PTLIM 2004/12/08	SD-87914-013																		
		APPROVED BY DATE	SHEET NO. 16 OF 46																		
		SCLOW 2004/12/10	THIS DRAWING CONTAINS INFORMATION THAT IS PROPRIETARY TO MOLEX INCORPORATED AND SHOULD NOT BE USED WITHOUT WRITTEN PERMISSION																		
		MATERIAL NO.																			
		SEE TABLE																			
		SIZE A3																			

PART NO FOR TRAY PACKAGING	PART NO. FOR TUBE WITHOUT CAP PACKAGING	PART NO. FOR TUBE WITH CAP PACKAGING	PART NO. FOR TAPE & REEL WITHOUT CAP PACKAGING	PART NO. FOR TAPE & REEL WITH CAP PACKAGING	CKT SIZE	VOID POSITION	PLATING TYPE	DIMENSION				
								A	B	F	M	P
								F	87914-2211	-----	-----	-----
	87914-2221	-----	-----	-----	22	----	1	27.94	25.40	12.25	7.00	2.96
	87914-2231	-----	-----	-----	22	----	1	27.94	25.40	13.38	6.09	5.00
	87914-2212	-----	-----	-----	22	----	2	27.94	25.40	10.92	5.84	2.79
	87914-2222	-----	-----	-----	22	----	2	27.94	25.40	12.25	7.00	2.96
	87914-2232	-----	-----	-----	22	----	2	27.94	25.40	13.38	6.09	5.00
E	87914-2213	-----	-----	-----	22	----	3	27.94	25.40	10.92	5.84	2.79
	87914-2223	-----	-----	-----	22	----	3	27.94	25.40	12.25	7.00	2.96
	87914-2233	-----	-----	-----	22	----	3	27.94	25.40	13.38	6.09	5.00
	87914-2214	-----	-----	-----	22	----	4	27.94	25.40	10.92	5.84	2.79
	87914-2224	-----	-----	-----	22	----	4	27.94	25.40	12.25	7.00	2.96
	87914-2234	-----	-----	-----	22	----	4	27.94	25.40	13.38	6.09	5.00
D	87914-2215	-----	-----	-----	22	----	5	27.94	25.40	10.92	5.84	2.79
	87914-2225	-----	-----	-----	22	----	5	27.94	25.40	12.25	7.00	2.96
	87914-2235	-----	-----	-----	22	----	5	27.94	25.40	13.38	6.09	5.00
	87914-2216	-----	-----	-----	22	----	6	27.94	25.40	10.92	5.84	2.79
	87914-2226	-----	-----	-----	22	----	6	27.94	25.40	12.25	7.00	2.96
	87914-2236	-----	-----	-----	22	----	6	27.94	25.40	13.38	6.09	5.00
C												
B												

PG8. +879140108 EC NO: S2010-0695 DRWN:ATSEE 2010/02/11 CHKD:PTLIM 2004/12/08 APPR:MLONG 2010/06/05 D7	QUALITY SYMBOLS $F_A=0$ $F_G=0$ $F_P=0$	GENERAL TOLERANCES (UNLESS SPECIFIED)		DIMENSION STYLE MM ONLY		SCALE NTS	DESIGN UNITS METRIC	THIRD ANGLE PROJECTION			
		4 PLACES \pm --- \pm --- 3 PLACES \pm --- \pm --- 2 PLACES ± 0.20 \pm --- 1 PLACE \pm --- \pm ---	mm INCH	DRAWN BY KCHO	DATE 2004/11/05	TITLE 2.54MM PITCH DUAL ROW HEADER SINGLE WAFER, T/H					
		ANGULAR $\pm 3^\circ$		CHECKED BY PTLIM	DATE 2004/12/08	MOLEX INCORPORATED					
		DRAFT WHERE APPLICABLE MUST REMAIN WITHIN DIMENSIONS		APPROVED BY SCLOW	DATE 2004/12/10	MATERIAL NO. SEE TABLE	DOCUMENT NO. SD-87914-013	SHEET NO. 17 OF 46			

PART NO FOR TRAY PACKAGING	PART NO. FOR TUBE WITHOUT CAP PACKAGING	PART NO. FOR TUBE WITH CAP PACKAGING	PART NO. FOR TAPE & REEL WITHOUT CAP PACKAGING	PART NO. FOR TAPE & REEL WITH CAP PACKAGING	CKT SIZE	VOID POSITION	PLATING TYPE	DIMENSION				
								A	B	F	M	P
F	87914-2411	-----	-----	-----	24	-----	1	30.48	27.94	10.92	5.84	2.79
	87914-2421	-----	-----	-----	24	-----	1	30.48	27.94	12.25	7.00	2.96
	87914-2431	-----	-----	-----	24	-----	1	30.48	27.94	13.38	6.09	5.00
	87914-2412	-----	-----	-----	24	-----	2	30.48	27.94	10.92	5.84	2.79
	87914-2422	-----	-----	-----	24	-----	2	30.48	27.94	12.25	7.00	2.96
	87914-2432	-----	-----	-----	24	-----	2	30.48	27.94	13.38	6.09	5.00
E	87914-2413	-----	-----	-----	24	-----	3	30.48	27.94	10.92	5.84	2.79
	87914-2423	-----	-----	-----	24	-----	3	30.48	27.94	12.25	7.00	2.96
	87914-2433	-----	-----	-----	24	-----	3	30.48	27.94	13.38	6.09	5.00
	87914-2414	-----	-----	-----	24	-----	4	30.48	27.94	10.92	5.84	2.79
	87914-2424	-----	-----	-----	24	-----	4	30.48	27.94	12.25	7.00	2.96
	87914-2434	-----	-----	-----	24	-----	4	30.48	27.94	13.38	6.09	5.00
D	87914-2415	-----	-----	-----	24	-----	5	30.48	27.94	10.92	5.84	2.79
	87914-2425	-----	-----	-----	24	-----	5	30.48	27.94	12.25	7.00	2.96
	87914-2435	-----	-----	-----	24	-----	5	30.48	27.94	13.38	6.09	5.00
	87914-2416	-----	-----	-----	24	-----	6	30.48	27.94	10.92	5.84	2.79
	87914-2426	-----	-----	-----	24	-----	6	30.48	27.94	12.25	7.00	2.96
	87914-2436	-----	-----	-----	24	-----	6	30.48	27.94	13.38	6.09	5.00
C												
B												

PG8, +879140108 EC NO: S2010-0695 DRWN:ATSEE 2010/02/11 CHKD:PTLIM 2004/12/08 APPR:MLONG 2010/06/05 D7	QUALITY SYMBOLS $F_A=0$ $F_G=0$ $F_P=0$	GENERAL TOLERANCES (UNLESS SPECIFIED) mm INCH		DIMENSION STYLE MM ONLY		SCALE NTS	DESIGN UNITS METRIC	THIRD ANGLE PROJECTION	
		4 PLACES ± --- ± ---	DRAWN BY KCHO	DATE 2004/11/05	2.54MM PITCH DUAL ROW HEADER SINGLE WAFER, T/H MOLEX INCORPORATED MATERIAL NO. DOCUMENT NO. SEE TABLE SD-87914-013				
		3 PLACES ± --- ± ---	CHECKED BY PTLIM	DATE 2004/12/08					
		2 PLACES ± 0.20 ± ---	APPROVED BY SCLOW	DATE 2004/12/10					
1 PLACE ± --- ± ---	MATERIAL NO. DOCUMENT NO. SEE TABLE SD-87914-013								
ANGULAR ± 3 °		DRAFT WHERE APPLICABLE MUST REMAIN WITHIN DIMENSIONS		THIS DRAWING CONTAINS INFORMATION THAT IS PROPRIETARY TO MOLEX INCORPORATED AND SHOULD NOT BE USED WITHOUT WRITTEN PERMISSION		SHEET NO. 18 OF 46			

PART NO FOR TRAY PACKAGING	PART NO. FOR TUBE WITHOUT CAP PACKAGING	PART NO. FOR TUBE WITH CAP PACKAGING	PART NO. FOR TAPE & REEL WITHOUT CAP PACKAGING	PART NO. FOR TAPE & REEL WITH CAP PACKAGING	CKT SIZE	VOID POSITION	PLATING TYPE	DIMENSION				
								A	B	F	M	P
								F	87914-2611	-----	-----	-----
	87914-2621	-----	-----	-----	26	----	1	33.02	30.48	12.25	7.00	2.96
	87914-2631	-----	-----	-----	26	----	1	33.02	30.48	13.38	6.09	5.00
	87914-2612	-----	-----	-----	26	----	2	33.02	30.48	10.92	5.84	2.79
	87914-2622	-----	-----	-----	26	----	2	33.02	30.48	12.25	7.00	2.96
	87914-2632	-----	-----	-----	26	----	2	33.02	30.48	13.38	6.09	5.00
E	87914-2613	-----	-----	-----	26	----	3	33.02	30.48	10.92	5.84	2.79
	87914-2623	-----	-----	-----	26	----	3	33.02	30.48	12.25	7.00	2.96
	87914-2633	-----	-----	-----	26	----	3	33.02	30.48	13.38	6.09	5.00
	87914-2614	-----	-----	-----	26	----	4	33.02	30.48	10.92	5.84	2.79
	87914-2624	-----	-----	-----	26	----	4	33.02	30.48	12.25	7.00	2.96
	87914-2634	-----	-----	-----	26	----	4	33.02	30.48	13.38	6.09	5.00
D	87914-2615	-----	-----	-----	26	----	5	33.02	30.48	10.92	5.84	2.79
	87914-2625	-----	-----	-----	26	----	5	33.02	30.48	12.25	7.00	2.96
	87914-2635	-----	-----	-----	26	----	5	33.02	30.48	13.38	6.09	5.00
	87914-2616	-----	-----	-----	26	----	6	33.02	30.48	10.92	5.84	2.79
	87914-2626	-----	-----	-----	26	----	6	33.02	30.48	12.25	7.00	2.96
	87914-2636	-----	-----	-----	26	----	6	33.02	30.48	13.38	6.09	5.00
C												
B												

PG8. +879140108 EC NO: S2010-0695 DRWN:ATSEE 2010/02/11 CHKD:PTLIM 2004/12/08 APPR:MLONG 2010/06/05 D7	QUALITY SYMBOLS $F_A=0$ $F_C=0$ $F_P=0$	GENERAL TOLERANCES (UNLESS SPECIFIED)		DIMENSION STYLE MM ONLY		SCALE NTS	DESIGN UNITS METRIC	THIRD ANGLE PROJECTION		
			mm	INCH	DRAWN BY	DATE	TITLE			
		4 PLACES	± ---	± ---	KCHO	2004/11/05	2.54MM PITCH DUAL ROW HEADER SINGLE WAFER, T/H			
		3 PLACES	± ---	± ---	CHECKED BY	DATE				
2 PLACES	± 0.20	± ---	PTLIM	2004/12/08	MOLEX INCORPORATED					
1 PLACE	± ---	± ---	APPROVED BY	DATE						
ANGULAR ± 3 °		DRAFT WHERE APPLICABLE MUST REMAIN WITHIN DIMENSIONS		SCLOW	2004/12/10	MATERIAL NO.	DOCUMENT NO.	SHEET NO.		
				SEE TABLE		SD-87914-013		19 OF 46		
				THIS DRAWING CONTAINS INFORMATION THAT IS PROPRIETARY TO MOLEX INCORPORATED AND SHOULD NOT BE USED WITHOUT WRITTEN PERMISSION						

	10	9	8	7	6	5	4	3	2	1			
	PART NO FOR TRAY PACKAGING	PART NO. FOR TUBE WITHOUT CAP PACKAGING	PART NO. FOR TUBE WITH CAP PACKAGING	PART NO. FOR TAPE & REEL WITHOUT CAP PACKAGING	PART NO. FOR TAPE & REEL WITH CAP PACKAGING	CKT SIZE	VOID POSITION	PLATING TYPE	DIMENSION				
									A	B	F	M	P
F	87914-2811	-----	-----	-----	-----	28	-----	1	35.56	33.02	10.92	5.84	2.79
	87914-2821	-----	-----	-----	-----	28	-----	1	35.56	33.02	12.25	7.00	2.96
	87914-2831	-----	-----	-----	-----	28	-----	1	35.56	33.02	13.38	6.09	5.00
	87914-2812	-----	-----	-----	-----	28	-----	2	35.56	33.02	10.92	5.84	2.79
	87914-2822	-----	-----	-----	-----	28	-----	2	35.56	33.02	12.25	7.00	2.96
	87914-2832	-----	-----	-----	-----	28	-----	2	35.56	33.02	13.38	6.09	5.00
E	87914-2813	-----	-----	-----	-----	28	-----	3	35.56	33.02	10.92	5.84	2.79
	87914-2823	-----	-----	-----	-----	28	-----	3	35.56	33.02	12.25	7.00	2.96
	87914-2833	-----	-----	-----	-----	28	-----	3	35.56	33.02	13.38	6.09	5.00
	87914-2814	-----	-----	-----	-----	28	-----	4	35.56	33.02	10.92	5.84	2.79
	87914-2824	-----	-----	-----	-----	28	-----	4	35.56	33.02	12.25	7.00	2.96
	87914-2834	-----	-----	-----	-----	28	-----	4	35.56	33.02	13.38	6.09	5.00
D	87914-2815	-----	-----	-----	-----	28	-----	5	35.56	33.02	10.92	5.84	2.79
	87914-2825	-----	-----	-----	-----	28	-----	5	35.56	33.02	12.25	7.00	2.96
	87914-2835	-----	-----	-----	-----	28	-----	5	35.56	33.02	13.38	6.09	5.00
	87914-2816	-----	-----	-----	-----	28	-----	6	35.56	33.02	10.92	5.84	2.79
	87914-2826	-----	-----	-----	-----	28	-----	6	35.56	33.02	12.25	7.00	2.96
	87914-2836	-----	-----	-----	-----	28	-----	6	35.56	33.02	13.38	6.09	5.00
C													
B													

A PG8. +879140108 EC NO: S2010-0695 DRWN:ATSEE 2010/02/11 CHKD:PTLIM 2004/12/08 APPR:MLONG 2010/06/05 D7	QUALITY SYMBOLS $F_A=0$ $F_G=0$ $F_P=0$	GENERAL TOLERANCES (UNLESS SPECIFIED) <table border="1"> <tr> <th></th> <th>mm</th> <th>INCH</th> </tr> <tr> <td>4 PLACES</td> <td>± ---</td> <td>± ---</td> </tr> <tr> <td>3 PLACES</td> <td>± ---</td> <td>± ---</td> </tr> <tr> <td>2 PLACES</td> <td>± 0.20</td> <td>± ---</td> </tr> <tr> <td>1 PLACE</td> <td>± ---</td> <td>± ---</td> </tr> </table>		mm	INCH	4 PLACES	± ---	± ---	3 PLACES	± ---	± ---	2 PLACES	± 0.20	± ---	1 PLACE	± ---	± ---	DIMENSION STYLE MM ONLY	SCALE NTS	DESIGN UNITS METRIC	THIRD ANGLE PROJECTION
		mm	INCH																		
	4 PLACES	± ---	± ---																		
	3 PLACES	± ---	± ---																		
2 PLACES	± 0.20	± ---																			
1 PLACE	± ---	± ---																			
		DRAFT WHERE APPLICABLE MUST REMAIN WITHIN DIMENSIONS	DRAWN BY KCHO	DATE 2004/11/05	TITLE 2.54MM PITCH DUAL ROW HEADER SINGLE WAFER, T/H																
			CHECKED BY PTLIM	DATE 2004/12/08	MOLEX INCORPORATED																
			APPROVED BY SCLOW	DATE 2004/12/10	MATERIAL NO. SEE TABLE	DOCUMENT NO. SD-87914-013															
				SIZE A3	THIS DRAWING CONTAINS INFORMATION THAT IS PROPRIETARY TO MOLEX INCORPORATED AND SHOULD NOT BE USED WITHOUT WRITTEN PERMISSION																

	10	9	8	7	6	5	4	3	2	1				
	PART NO FOR TRAY PACKAGING	PART NO. FOR TUBE WITHOUT CAP PACKAGING	PART NO. FOR TUBE WITH CAP PACKAGING	PART NO. FOR TAPE & REEL WITHOUT CAP PACKAGING	PART NO. FOR TAPE & REEL WITH CAP PACKAGING	CKT SIZE	VOID POSITION	PLATING TYPE	DIMENSION					
								A	B	F	M	P		
F	87914-3011	-----	-----	-----	-----	30	----	1	38.10	35.56	10.92	5.84	2.79	F
	87914-3021	-----	-----	-----	-----	30	----	1	38.10	35.56	12.25	7.00	2.96	
	87914-3031	-----	-----	-----	-----	30	----	1	38.10	35.56	13.38	6.09	5.00	
	87914-3012	-----	-----	-----	-----	30	----	2	38.10	35.56	10.92	5.84	2.79	
	87914-3022	-----	-----	-----	-----	30	----	2	38.10	35.56	12.25	7.00	2.96	
	87914-3032	-----	-----	-----	-----	30	----	2	38.10	35.56	13.38	6.09	5.00	
E	87914-3013	-----	-----	-----	-----	30	----	3	38.10	35.56	10.92	5.84	2.79	E
	87914-3023	-----	-----	-----	-----	30	----	3	38.10	35.56	12.25	7.00	2.96	
	87914-3033	-----	-----	-----	-----	30	----	3	38.10	35.56	13.38	6.09	5.00	
	87914-3014	-----	-----	-----	-----	30	----	4	38.10	35.56	10.92	5.84	2.79	
	87914-3024	-----	-----	-----	-----	30	----	4	38.10	35.56	12.25	7.00	2.96	
	87914-3034	-----	-----	-----	-----	30	----	4	38.10	35.56	13.38	6.09	5.00	
D	87914-3015	-----	-----	-----	-----	30	----	5	38.10	35.56	10.92	5.84	2.79	D
	87914-3025	-----	-----	-----	-----	30	----	5	38.10	35.56	12.25	7.00	2.96	
	87914-3035	-----	-----	-----	-----	30	----	5	38.10	35.56	13.38	6.09	5.00	
	87914-3016	-----	-----	-----	-----	30	----	6	38.10	35.56	10.92	5.84	2.79	
	87914-3026	-----	-----	-----	-----	30	----	6	38.10	35.56	12.25	7.00	2.96	
	87914-3036	-----	-----	-----	-----	30	----	6	38.10	35.56	13.38	6.09	5.00	
C														C
B														B

PG8. +879140108 EC NO: S2010-0695 DRWN:ATSEE 2010/02/11 CHKD:PTLIM 2004/12/08 APPR:MLONG 2010/06/05 D7	QUALITY SYMBOLS	GENERAL TOLERANCES (UNLESS SPECIFIED)	DIMENSION STYLE	SCALE	DESIGN UNITS	THIRD ANGLE PROJECTION															
	$F_A=0$ $F_G=0$ $F_P=0$	<table border="1"> <tr><th colspan="2">mm</th><th>INCH</th></tr> <tr><td>4 PLACES</td><td>± ---</td><td>± ---</td></tr> <tr><td>3 PLACES</td><td>± ---</td><td>± ---</td></tr> <tr><td>2 PLACES</td><td>± 0.20</td><td>± ---</td></tr> <tr><td>1 PLACE</td><td>± ---</td><td>± ---</td></tr> </table>	mm		INCH	4 PLACES	± ---	± ---	3 PLACES	± ---	± ---	2 PLACES	± 0.20	± ---	1 PLACE	± ---	± ---	MM ONLY	NTS	METRIC	
	mm		INCH																		
	4 PLACES	± ---	± ---																		
3 PLACES	± ---	± ---																			
2 PLACES	± 0.20	± ---																			
1 PLACE	± ---	± ---																			
DESCRIPTION	ANGULAR ± 3 °	DRAWN BY DATE	TITLE																		
	DRAFT WHERE APPLICABLE MUST REMAIN WITHIN DIMENSIONS	KCHO 2004/11/05	2.54MM PITCH DUAL ROW HEADER SINGLE WAFER, T/H																		
		CHECKED BY DATE	MOLEX INCORPORATED																		
		PTLIM 2004/12/08	SD-87914-013																		
		APPROVED BY DATE	SHEET NO. 21 OF 46																		
		SCLOW 2004/12/10	THIS DRAWING CONTAINS INFORMATION THAT IS PROPRIETARY TO MOLEX INCORPORATED AND SHOULD NOT BE USED WITHOUT WRITTEN PERMISSION																		
		MATERIAL NO.																			
		SEE TABLE																			
		SIZE A3																			

	10	9	8	7	6	5	4	3	2	1			
	PART NO. FOR TRAY PACKAGING	PART NO. FOR TUBE WITHOUT CAP PACKAGING	PART NO. FOR TUBE WITH CAP PACKAGING	PART NO. FOR TAPE & REEL WITHOUT CAP PACKAGING	PART NO. FOR TAPE & REEL WITH CAP PACKAGING	CKT SIZE	VOID POSITION	PLATING TYPE	DIMENSION				
									A	B	F	M	P
F	87914-3211	-----	-----	-----	-----	32	----	1	40.64	38.10	10.92	5.84	2.79
	87914-3221	-----	-----	-----	-----	32	----	1	40.64	38.10	12.25	7.00	2.96
	87914-3231	-----	-----	-----	-----	32	----	1	40.64	38.10	13.38	6.09	5.00
	87914-3212	-----	-----	-----	-----	32	----	2	40.64	38.10	10.92	5.84	2.79
	87914-3222	-----	-----	-----	-----	32	----	2	40.64	38.10	12.25	7.00	2.96
	87914-3232	-----	-----	-----	-----	32	----	2	40.64	38.10	13.38	6.09	5.00
E	87914-3213	-----	-----	-----	-----	32	----	3	40.64	38.10	10.92	5.84	2.79
	87914-3223	-----	-----	-----	-----	32	----	3	40.64	38.10	12.25	7.00	2.96
	87914-3233	-----	-----	-----	-----	32	----	3	40.64	38.10	13.38	6.09	5.00
	87914-3214	-----	-----	-----	-----	32	----	4	40.64	38.10	10.92	5.84	2.79
	87914-3224	-----	-----	-----	-----	32	----	4	40.64	38.10	12.25	7.00	2.96
	87914-3234	-----	-----	-----	-----	32	----	4	40.64	38.10	13.38	6.09	5.00
D	87914-3215	-----	-----	-----	-----	32	----	5	40.64	38.10	10.92	5.84	2.79
	87914-3225	-----	-----	-----	-----	32	----	5	40.64	38.10	12.25	7.00	2.96
	87914-3235	-----	-----	-----	-----	32	----	5	40.64	38.10	13.38	6.09	5.00
	87914-3216	-----	-----	-----	-----	32	----	6	40.64	38.10	10.92	5.84	2.79
	87914-3226	-----	-----	-----	-----	32	----	6	40.64	38.10	12.25	7.00	2.96
	87914-3236	-----	-----	-----	-----	32	----	6	40.64	38.10	13.38	6.09	5.00
C													
B													

PG8. +879140108 EC NO: S2010-0695 DRWN:ATSEE 2010/02/11 CHKD:PTLIM 2004/12/08 APPR:MLONG 2010/06/05 D7	QUALITY SYMBOLS $\nabla_A = 0$ $\nabla_G = 0$ $\nabla_P = 0$	GENERAL TOLERANCES (UNLESS SPECIFIED)	DIMENSION STYLE MM ONLY	SCALE NTS	DESIGN UNITS METRIC	THIRD ANGLE PROJECTION
		4 PLACES \pm --- \pm --- 3 PLACES \pm --- \pm --- 2 PLACES \pm 0.20 \pm --- 1 PLACE \pm --- \pm --- ANGULAR \pm 3 °	DRAWN BY: KCHO DATE: 2004/11/05 CHECKED BY: PTLIM DATE: 2004/12/08 APPROVED BY: SCLOW DATE: 2004/12/10	TITLE 2.54MM PITCH DUAL ROW HEADER SINGLE WAFER, T/H	MOLEX INCORPORATED	
		DRAFT WHERE APPLICABLE MUST REMAIN WITHIN DIMENSIONS	SEE TABLE	DOCUMENT NO. SD-87914-013		SHEET NO. 22 OF 46
		SIZE A3 THIS DRAWING CONTAINS INFORMATION THAT IS PROPRIETARY TO MOLEX INCORPORATED AND SHOULD NOT BE USED WITHOUT WRITTEN PERMISSION				

PART NO FOR TRAY PACKAGING	PART NO. FOR TUBE WITHOUT CAP PACKAGING	PART NO. FOR TUBE WITH CAP PACKAGING	PART NO. FOR TAPE & REEL WITHOUT CAP PACKAGING	PART NO. FOR TAPE & REEL WITH CAP PACKAGING	CKT SIZE	VOID POSITION	PLATING TYPE	DIMENSION				
								A	B	F	M	D
								F	87914-3411	-----	-----	-----
	87914-3421	-----	-----	-----	34	----	1	43.18	40.64	12.25	7.00	2.96
	87914-3431	-----	-----	-----	34	----	1	43.18	40.64	13.38	6.09	5.00
	87914-3412	-----	-----	-----	34	----	2	43.18	40.64	10.92	5.84	2.79
	87914-3422	-----	-----	-----	34	----	2	43.18	40.64	12.25	7.00	2.96
	87914-3432	-----	-----	-----	34	----	2	43.18	40.64	13.38	6.09	5.00
E	87914-3413	-----	-----	-----	34	----	3	43.18	40.64	10.92	5.84	2.79
	87914-3423	-----	-----	-----	34	----	3	43.18	40.64	12.25	7.00	2.96
	87914-3433	-----	-----	-----	34	----	3	43.18	40.64	13.38	6.09	5.00
	87914-3414	-----	-----	-----	34	----	4	43.18	40.64	10.92	5.84	2.79
	87914-3424	-----	-----	-----	34	----	4	43.18	40.64	12.25	7.00	2.96
	87914-3434	-----	-----	-----	34	----	4	43.18	40.64	13.38	6.09	5.00
D	87914-3415	-----	-----	-----	34	----	5	43.18	40.64	10.92	5.84	2.79
	87914-3425	-----	-----	-----	34	----	5	43.18	40.64	12.25	7.00	2.96
	87914-3435	-----	-----	-----	34	----	5	43.18	40.64	13.38	6.09	5.00
	87914-3416	-----	-----	-----	34	----	6	43.18	40.64	10.92	5.84	2.79
	87914-3426	-----	-----	-----	34	----	6	43.18	40.64	12.25	7.00	2.96
	87914-3436	-----	-----	-----	34	----	6	43.18	40.64	13.38	6.09	5.00
C												
B												

PG8. +879140108 EC NO: S2010-0695 DRWN:ATSEE 2010/02/11 CHKD:PTLIM 2004/12/08 APPR:MLONG 2010/06/05 D7	QUALITY SYMBOLS $F_A=0$ $F_G=0$ $F_P=0$	GENERAL TOLERANCES (UNLESS SPECIFIED)		DIMENSION STYLE MM ONLY	SCALE NTS	DESIGN UNITS METRIC	THIRD ANGLE PROJECTION		
		4 PLACES \pm --- \pm --- 3 PLACES \pm --- \pm --- 2 PLACES \pm 0.20 \pm --- 1 PLACE \pm --- \pm ---	mm INCH	DRAWN BY KCHO	DATE 2004/11/05	TITLE 2.54MM PITCH DUAL ROW HEADER SINGLE WAFER, T/H			
		ANGULAR \pm 3 °		CHECKED BY PTLIM	DATE 2004/12/08	MOLEX INCORPORATED			
		DRAFT WHERE APPLICABLE MUST REMAIN WITHIN DIMENSIONS		APPROVED BY SCLOW	DATE 2004/12/10	MATERIAL NO. SEE TABLE	DOCUMENT NO. SD-87914-013	SHEET NO. 23 OF 46	

	10		9		8		7		6		5		4		3		2		1		
	PART NO FOR TRAY PACKAGING	PART NO. FOR TUBE WITHOUT CAP PACKAGING	PART NO. FOR TUBE WITH CAP PACKAGING	PART NO. FOR TAPE & REEL WITHOUT CAP PACKAGING	PART NO. FOR TAPE & REEL WITH CAP PACKAGING	CKT SIZE	VOID POSITION	PLATING TYPE	DIMENSION												
									A	B	F	M	P								
F	87914-3611	-----	-----	-----	-----	36	----	1	45.72	43.18	10.92	5.84	2.79								
	87914-3621	-----	-----	-----	-----	36	----	1	45.72	43.18	12.25	7.00	2.96								
	87914-3631	-----	-----	-----	-----	36	----	1	45.72	43.18	13.38	6.09	5.00								
	87914-3612	-----	-----	-----	-----	36	----	2	45.72	43.18	10.92	5.84	2.79								
	87914-3622	-----	-----	-----	-----	36	----	2	45.72	43.18	12.25	7.00	2.96								
	87914-3632	-----	-----	-----	-----	36	----	2	45.72	43.18	13.38	6.09	5.00								
E	87914-3613	-----	-----	-----	-----	36	----	3	45.72	43.18	10.92	5.84	2.79								
	87914-3623	-----	-----	-----	-----	36	----	3	45.72	43.18	12.25	7.00	2.96								
	87914-3633	-----	-----	-----	-----	36	----	3	45.72	43.18	13.38	6.09	5.00								
	87914-3614	-----	-----	-----	-----	36	----	4	45.72	43.18	10.92	5.84	2.79								
	87914-3624	-----	-----	-----	-----	36	----	4	45.72	43.18	12.25	7.00	2.96								
	87914-3634	-----	-----	-----	-----	36	----	4	45.72	43.18	13.38	6.09	5.00								
D	87914-3615	-----	-----	-----	-----	36	----	5	45.72	43.18	10.92	5.84	2.79								
	87914-3625	-----	-----	-----	-----	36	----	5	45.72	43.18	12.25	7.00	2.96								
	87914-3635	-----	-----	-----	-----	36	----	5	45.72	43.18	13.38	6.09	5.00								
	87914-3616	-----	-----	-----	-----	36	----	6	45.72	43.18	10.92	5.84	2.79								
	87914-3626	-----	-----	-----	-----	36	----	6	45.72	43.18	12.25	7.00	2.96								
	87914-3636	-----	-----	-----	-----	36	----	6	45.72	43.18	13.38	6.09	5.00								
C	87914-3637	-----	-----	-----	-----	36	----	6	45.72	43.18	12.10	7.21	2.60								
B																					

PG8. +879140108 EC NO: S2010-0695 DRWN:ATSEE 2010/02/11 CHKD:PTLIM 2004/12/08 APPR:MLONG 2010/06/05	DESCRIPTION REV D7	QUALITY SYMBOLS	GENERAL TOLERANCES (UNLESS SPECIFIED)	DIMENSION STYLE	SCALE	DESIGN UNITS	THIRD ANGLE PROJECTION														
		$F_A = 0$ $F_G = 0$ $F_P = 0$	<table border="1"> <thead> <tr> <th></th> <th>mm</th> <th>INCH</th> </tr> </thead> <tbody> <tr> <td>4 PLACES</td> <td>± ---</td> <td>± ---</td> </tr> <tr> <td>3 PLACES</td> <td>± ---</td> <td>± ---</td> </tr> <tr> <td>2 PLACES</td> <td>± 0.20</td> <td>± ---</td> </tr> <tr> <td>1 PLACE</td> <td>± ---</td> <td>± ---</td> </tr> </tbody> </table>		mm	INCH	4 PLACES	± ---	± ---	3 PLACES	± ---	± ---	2 PLACES	± 0.20	± ---	1 PLACE	± ---	± ---	MM ONLY DRAWN BY DATE KCHO 2004/11/05 CHECKED BY DATE PTLIM 2004/12/08 APPROVED BY DATE SCLOW 2004/12/10 MATERIAL NO.	NTS METRIC MOLEX	TITLE 2.54MM PITCH DUAL ROW HEADER SINGLE WAFER, T/H MOLEX INCORPORATED DOCUMENT NO. SD-87914-013
			mm	INCH																	
		4 PLACES	± ---	± ---																	
3 PLACES	± ---	± ---																			
2 PLACES	± 0.20	± ---																			
1 PLACE	± ---	± ---																			
ANGULAR ± 3 ° DRAFT WHERE APPLICABLE MUST REMAIN WITHIN DIMENSIONS	SEE TABLE THIS DRAWING CONTAINS INFORMATION THAT IS PROPRIETARY TO MOLEX INCORPORATED AND SHOULD NOT BE USED WITHOUT WRITTEN PERMISSION	SHEET NO. 24 OF 46																			

F	10	9	8	7	6	5	4	3	2	1			
	PART NO FOR TRAY PACKAGING	PART NO. FOR TUBE WITHOUT CAP PACKAGING	PART NO. FOR TUBE WITH CAP PACKAGING	PART NO. FOR TAPE & REEL WITHOUT CAP PACKAGING	PART NO. FOR TAPE & REEL WITH CAP PACKAGING	CKT SIZE	VOID POSITION	PLATING TYPE	DIMENSION				
									A	B	F	M	P
	87914-3811	-----	-----	-----	-----	38	----	1	48.26	45.72	10.92	5.84	2.79
	87914-3821	-----	-----	-----	-----	38	----	1	48.26	45.72	12.25	7.00	2.96
	87914-3831	-----	-----	-----	-----	38	----	1	48.26	45.72	13.38	6.09	5.00
	87914-3812	-----	-----	-----	-----	38	----	2	48.26	45.72	10.92	5.84	2.79
	87914-3822	-----	-----	-----	-----	38	----	2	48.26	45.72	12.25	7.00	2.96
	87914-3832	-----	-----	-----	-----	38	----	2	48.26	45.72	13.38	6.09	5.00
E	87914-3813	-----	-----	-----	-----	38	----	3	48.26	45.72	10.92	5.84	2.79
	87914-3823	-----	-----	-----	-----	38	----	3	48.26	45.72	12.25	7.00	2.96
	87914-3833	-----	-----	-----	-----	38	----	3	48.26	45.72	13.38	6.09	5.00
	87914-3814	-----	-----	-----	-----	38	----	4	48.26	45.72	10.92	5.84	2.79
	87914-3824	-----	-----	-----	-----	38	----	4	48.26	45.72	12.25	7.00	2.96
	87914-3834	-----	-----	-----	-----	38	----	4	48.26	45.72	13.38	6.09	5.00
D	87914-3815	-----	-----	-----	-----	38	----	5	48.26	45.72	10.92	5.84	2.79
	87914-3825	-----	-----	-----	-----	38	----	5	48.26	45.72	12.25	7.00	2.96
	87914-3835	-----	-----	-----	-----	38	----	5	48.26	45.72	13.38	6.09	5.00
	87914-3816	-----	-----	-----	-----	38	----	6	48.26	45.72	10.92	5.84	2.79
	87914-3826	-----	-----	-----	-----	38	----	6	48.26	45.72	12.25	7.00	2.96
	87914-3836	-----	-----	-----	-----	38	----	6	48.26	45.72	13.38	6.09	5.00
C													
B													

PG8. +879140108 EC NO: S2010-0695 DRWN:ATSEE 2010/02/11 CHKD:PTLIM 2004/12/08 APPR:MLONG 2010/06/05 D7	QUALITY SYMBOLS $F_A=0$ $F_G=0$ $F_P=0$	GENERAL TOLERANCES (UNLESS SPECIFIED)		DIMENSION STYLE MM ONLY		SCALE NTS	DESIGN UNITS METRIC	THIRD ANGLE PROJECTION		
				DRAWN BY KCHO	DATE 2004/11/05	TITLE 2.54MM PITCH DUAL ROW HEADER SINGLE WAFER, T/H				
				CHECKED BY PTLIM	DATE 2004/12/08	APPROVED BY SCLOW				
				MATERIAL NO. SEE TABLE		DATE 2004/12/10	DOCUMENT NO. SD-87914-013		SHEET NO. 25 OF 46	
		DRAFT WHERE APPLICABLE MUST REMAIN WITHIN DIMENSIONS		SIZE A3		THIS DRAWING CONTAINS INFORMATION THAT IS PROPRIETARY TO MOLEX INCORPORATED AND SHOULD NOT BE USED WITHOUT WRITTEN PERMISSION				

	10	9	8	7	6	5	4	3	2	1			
	PART NO FOR TRAY PACKAGING	PART NO. FOR TUBE WITHOUT CAP PACKAGING	PART NO. FOR TUBE WITH CAP PACKAGING	PART NO. FOR TAPE & REEL WITHOUT CAP PACKAGING	PART NO. FOR TAPE & REEL WITH CAP PACKAGING	CKT SIZE	VOID POSITION	PLATING TYPE	DIMENSION				
								A	B	F	M	P	
F	87914-4011	-----	-----	-----	-----	40	----	1	50.80	48.26	10.92	5.84	2.79
	87914-4021	-----	-----	-----	-----	40	----	1	50.80	48.26	12.25	7.00	2.96
	87914-4031	-----	-----	-----	-----	40	----	1	50.80	48.26	13.38	6.09	5.00
	87914-4012	-----	-----	-----	-----	40	----	2	50.80	48.26	10.92	5.84	2.79
	87914-4022	-----	-----	-----	-----	40	----	2	50.80	48.26	12.25	7.00	2.96
	87914-4032	-----	-----	-----	-----	40	----	2	50.80	48.26	13.38	6.09	5.00
E	87914-4013	-----	-----	-----	-----	40	----	3	50.80	48.26	10.92	5.84	2.79
	87914-4023	-----	-----	-----	-----	40	----	3	50.80	48.26	12.25	7.00	2.96
	87914-4033	-----	-----	-----	-----	40	----	3	50.80	48.26	13.38	6.09	5.00
	87914-4014	-----	-----	-----	-----	40	----	4	50.80	48.26	10.92	5.84	2.79
	87914-4024	-----	-----	-----	-----	40	----	4	50.80	48.26	12.25	7.00	2.96
	87914-4034	-----	-----	-----	-----	40	----	4	50.80	48.26	13.38	6.09	5.00
D	87914-4015	-----	-----	-----	-----	40	----	5	50.80	48.26	10.92	5.84	2.79
	87914-4025	-----	-----	-----	-----	40	----	5	50.80	48.26	12.25	7.00	2.96
	87914-4035	-----	-----	-----	-----	40	----	5	50.80	48.26	13.38	6.09	5.00
	87914-4016	-----	-----	-----	-----	40	----	6	50.80	48.26	10.92	5.84	2.79
	87914-4026	-----	-----	-----	-----	40	----	6	50.80	48.26	12.25	7.00	2.96
	87914-4036	-----	-----	-----	-----	40	----	6	50.80	48.26	13.38	6.09	5.00
C													
B													

PG8. +879140108 EC NO: S2010-0695 DRWN:ATSEE 2010/02/11 CHKD:PTLIM 2004/12/08 APPR:MLONG 2010/06/05	DESCRIPTION REV	QUALITY SYMBOLS	GENERAL TOLERANCES (UNLESS SPECIFIED)	DIMENSION STYLE	SCALE	DESIGN UNITS	THIRD ANGLE PROJECTION
		$F_A=0$ $F_G=0$ $F_P=0$	(UNLESS SPECIFIED) mm INCH	MM ONLY	NTS	METRIC	
		4 PLACES ± --- ± --- 3 PLACES ± --- ± --- 2 PLACES ± 0.20 ± --- 1 PLACE ± --- ± ---	DRAWN BY DATE KCHO 2004/11/05 CHECKED BY DATE PTLIM 2004/12/08 APPROVED BY DATE SCLOW 2004/12/10	TITLE 2.54MM PITCH DUAL ROW HEADER SINGLE WAFER, T/H			
		ANGULAR ± 3 ° DRAFT WHERE APPLICABLE MUST REMAIN WITHIN DIMENSIONS	MATERIAL NO. SEE TABLE SIZE A3	DOCUMENT NO. SD-87914-013 SHEET NO. 26 OF 46			

	10	9	8	7	6	5	4	3	2	1			
	PART NO FOR TRAY PACKAGING	PART NO. FOR TUBE WITHOUT CAP PACKAGING	PART NO. FOR TUBE WITH CAP PACKAGING	PART NO. FOR TAPE & REEL WITHOUT CAP PACKAGING	PART NO. FOR TAPE & REEL WITH CAP PACKAGING	CKT SIZE	VOID POSITION	PLATING TYPE	DIMENSION				
									A	B	F	M	P
F	87914-4211	-----	-----	-----	-----	42	-----	1	53.34	50.80	10.92	5.84	2.79
	87914-4221	-----	-----	-----	-----	42	-----	1	53.34	50.80	12.25	7.00	2.96
	87914-4212	-----	-----	-----	-----	42	-----	2	53.34	50.80	10.92	5.84	2.79
	87914-4222	-----	-----	-----	-----	42	-----	2	53.34	50.80	12.25	7.00	2.96
	87914-4213	-----	-----	-----	-----	42	-----	3	53.34	50.80	10.92	5.84	2.79
	87914-4223	-----	-----	-----	-----	42	-----	3	53.34	50.80	12.25	7.00	2.96
E	87914-4214	-----	-----	-----	-----	42	-----	4	53.34	50.80	10.92	5.84	2.79
	87914-4224	-----	-----	-----	-----	42	-----	4	53.34	50.80	12.25	7.00	2.96
	87914-4215	-----	-----	-----	-----	42	-----	5	53.34	50.80	10.92	5.84	2.79
	87914-4225	-----	-----	-----	-----	42	-----	5	53.34	50.80	12.25	7.00	2.96
	87914-4216	-----	-----	-----	-----	42	-----	6	53.34	50.80	10.92	5.84	2.79
	87914-4226	-----	-----	-----	-----	42	-----	6	53.34	50.80	12.25	7.00	2.96
D													
C													
B													

PG8, +879140108 EC NO: S2010-0695 DRWN:ATSEE 2010/02/11 CHKD:PTLIM 2004/12/08 APPR:MLONG 2010/06/05 D7	QUALITY SYMBOLS $F_A=0$ $F_C=0$ $F_B=0$	GENERAL TOLERANCES (UNLESS SPECIFIED) mm INCH 4 PLACES \pm --- \pm --- 3 PLACES \pm --- \pm --- 2 PLACES \pm 0.20 \pm --- 1 PLACE \pm --- \pm --- ANGULAR \pm 3 °	DIMENSION STYLE MM ONLY DRAWN BY DATE KCHO 2004/11/05 CHECKED BY DATE PTLIM 2004/12/08 APPROVED BY DATE SCLOW 2004/12/10	SCALE NTS DESIGN UNITS METRIC	THIRD ANGLE PROJECTION	2.54MM PITCH DUAL ROW HEADER SINGLE WAFER, T/H MOLEX INCORPORATED MATERIAL NO. DOCUMENT NO. SEE TABLE SD-87914-013	SHEET NO. 27 OF 46
	DRAFT WHERE APPLICABLE MUST REMAIN WITHIN DIMENSIONS						
	THIS DRAWING CONTAINS INFORMATION THAT IS PROPRIETARY TO MOLEX INCORPORATED AND SHOULD NOT BE USED WITHOUT WRITTEN PERMISSION						

PART NO FOR TRAY PACKAGING	PART NO. FOR TUBE WITHOUT CAP PACKAGING	PART NO. FOR TUBE WITH CAP PACKAGING	PART NO. FOR TAPE & REEL WITHOUT CAP PACKAGING	PART NO. FOR TAPE & REEL WITH CAP PACKAGING	CKT SIZE	VOID POSITION	PLATING TYPE	DIMENSION				
								A	B	F	M	P
F	87914-4411	-----	-----	-----	44	----	1	55.88	53.34	10.92	5.84	2.79
	87914-4421	-----	-----	-----	44	----	1	55.88	53.34	12.25	7.00	2.96
	87914-4412	-----	-----	-----	44	----	2	55.88	53.34	10.92	5.84	2.79
	87914-4422	-----	-----	-----	44	----	2	55.88	53.34	12.25	7.00	2.96
	87914-4413	-----	-----	-----	44	----	3	55.88	53.34	10.92	5.84	2.79
	87914-4423	-----	-----	-----	44	----	3	55.88	53.34	12.25	7.00	2.96
E	87914-4414	-----	-----	-----	44	----	4	55.88	53.34	10.92	5.84	2.79
	87914-4424	-----	-----	-----	44	----	4	55.88	53.34	12.25	7.00	2.96
	87914-4415	-----	-----	-----	44	----	5	55.88	53.34	10.92	5.84	2.79
	87914-4425	-----	-----	-----	44	----	5	55.88	53.34	12.25	7.00	2.96
	87914-4416	-----	-----	-----	44	----	6	55.88	53.34	10.92	5.84	2.79
	87914-4426	-----	-----	-----	44	----	6	55.88	53.34	12.25	7.00	2.96
D												
C												
B												

PG8, +879140108 EC NO: S2010-0695 DRWN:ATSEE 2010/02/11 CHKD:PTLIM 2004/12/08 APPR:MLONG 2010/06/05 REV	QUALITY SYMBOLS	GENERAL TOLERANCES (UNLESS SPECIFIED)		DIMENSION STYLE	SCALE	DESIGN UNITS	THIRD ANGLE PROJECTION		
	$F_A=0$	mm INCH		MM ONLY	NTS	METRIC	⊘ □		
	$F_G=0$	4 PLACES	± --- ± ---	DRAWN BY	DATE	2.54MM PITCH DUAL ROW HEADER SINGLE WAFER, T/H			
	$F_P=0$	3 PLACES	± --- ± ---	KCHO	2004/11/05				
		2 PLACES	± 0.20 ± ---	CHECKED BY	DATE	MOLEX INCORPORATED			
	1 PLACE	± --- ± ---	PTLIM	2004/12/08					
		ANGULAR ± 3°	APPROVED BY	DATE	SD-87914-013				
			SLOW	2004/12/10					
			MATERIAL NO.	DOCUMENT NO.	SEE TABLE 28 OF 46				
			SIZE	THIS DRAWING CONTAINS INFORMATION THAT IS PROPRIETARY TO MOLEX INCORPORATED AND SHOULD NOT BE USED WITHOUT WRITTEN PERMISSION					

	10	9	8	7	6	5	4	3	2	1			
	PART NO FOR TRAY PACKAGING	PART NO. FOR TUBE WITHOUT CAP PACKAGING	PART NO. FOR TUBE WITH CAP PACKAGING	PART NO. FOR TAPE & REEL WITHOUT CAP PACKAGING	PART NO. FOR TAPE & REEL WITH CAP PACKAGING	CKT SIZE	VOID POSITION	PLATING TYPE	DIMENSION				
									A	B	F	M	P
F	87914-4611	-----	-----	-----	-----	46	----	1	58.42	55.88	10.92	5.84	2.79
	87914-4621	-----	-----	-----	-----	46	----	1	58.42	55.88	12.25	7.00	2.96
	87914-4612	-----	-----	-----	-----	46	----	2	58.42	55.88	10.92	5.84	2.79
	87914-4622	-----	-----	-----	-----	46	----	2	58.42	55.88	12.25	7.00	2.96
	87914-4613	-----	-----	-----	-----	46	----	3	58.42	55.88	10.92	5.84	2.79
	87914-4623	-----	-----	-----	-----	46	----	3	58.42	55.88	12.25	7.00	2.96
E	87914-4614	-----	-----	-----	-----	46	----	4	58.42	55.88	10.92	5.84	2.79
	87914-4624	-----	-----	-----	-----	46	----	4	58.42	55.88	12.25	7.00	2.96
	87914-4615	-----	-----	-----	-----	46	----	5	58.42	55.88	10.92	5.84	2.79
	87914-4625	-----	-----	-----	-----	46	----	5	58.42	55.88	12.25	7.00	2.96
	87914-4616	-----	-----	-----	-----	46	----	6	58.42	55.88	10.92	5.84	2.79
	87914-4626	-----	-----	-----	-----	46	----	6	58.42	55.88	12.25	7.00	2.96
D													
C													
B													

PG8. +879140108 EC NO: S2010-0695 DRWN:ATSEE 2010/02/11 CHKD:PTLIM 2004/12/08 APPR:MLONG 2010/06/05	QUALITY SYMBOLS $F_A=0$ $F_C=0$ $F_P=0$	GENERAL TOLERANCES (UNLESS SPECIFIED) <table border="1"> <tr> <th></th> <th>mm</th> <th>INCH</th> </tr> <tr> <td>4 PLACES</td> <td>\pm---</td> <td>\pm---</td> </tr> <tr> <td>3 PLACES</td> <td>\pm---</td> <td>\pm---</td> </tr> <tr> <td>2 PLACES</td> <td>\pm0.20</td> <td>\pm---</td> </tr> <tr> <td>1 PLACE</td> <td>\pm---</td> <td>\pm---</td> </tr> </table>		mm	INCH	4 PLACES	\pm ---	\pm ---	3 PLACES	\pm ---	\pm ---	2 PLACES	\pm 0.20	\pm ---	1 PLACE	\pm ---	\pm ---	DIMENSION STYLE MM ONLY	SCALE NTS	DESIGN UNITS METRIC	THIRD ANGLE PROJECTION
		mm	INCH																		
	4 PLACES	\pm ---	\pm ---																		
	3 PLACES	\pm ---	\pm ---																		
2 PLACES	\pm 0.20	\pm ---																			
1 PLACE	\pm ---	\pm ---																			
			DRAWN BY: KCHO CHECKED BY: PTLIM APPROVED BY: SCLOW	DATE: 2004/11/05 DATE: 2004/12/08 DATE: 2004/12/10	TITLE 2.54MM PITCH DUAL ROW HEADER SINGLE WAFER, T/H																
		DRAFT WHERE APPLICABLE MUST REMAIN WITHIN DIMENSIONS	MATERIAL NO. SEE TABLE	DOCUMENT NO. MOLEX INCORPORATED SD-87914-013			SHEET NO. 29 OF 46														
			SIZE A3	THIS DRAWING CONTAINS INFORMATION THAT IS PROPRIETARY TO MOLEX INCORPORATED AND SHOULD NOT BE USED WITHOUT WRITTEN PERMISSION																	

PART NO FOR TRAY PACKAGING	PART NO. FOR TUBE WITHOUT CAP PACKAGING	PART NO. FOR TUBE WITH CAP PACKAGING	PART NO. FOR TAPE & REEL WITHOUT CAP PACKAGING	PART NO. FOR TAPE & REEL WITH CAP PACKAGING	CKT SIZE	VOID POSITION	PLATING TYPE	DIMENSION				
								A	B	F	M	P
								F	87914-4811	-----	-----	-----
	87914-4821	-----	-----	-----	48	----	1	60.96	58.42	12.25	7.00	2.96
	87914-4812	-----	-----	-----	48	----	2	60.96	58.42	10.92	5.84	2.79
	87914-4822	-----	-----	-----	48	----	2	60.96	58.42	12.25	7.00	2.96
	87914-4813	-----	-----	-----	48	----	3	60.96	58.42	10.92	5.84	2.79
	87914-4823	-----	-----	-----	48	----	3	60.96	58.42	12.25	7.00	2.96
E	87914-4814	-----	-----	-----	48	----	4	60.96	58.42	10.92	5.84	2.79
	87914-4824	-----	-----	-----	48	----	4	60.96	58.42	12.25	7.00	2.96
	87914-4815	-----	-----	-----	48	----	5	60.96	58.42	10.92	5.84	2.79
	87914-4825	-----	-----	-----	48	----	5	60.96	58.42	12.25	7.00	2.96
	87914-4816	-----	-----	-----	48	----	6	60.96	58.42	10.92	5.84	2.79
	87914-4826	-----	-----	-----	48	----	6	60.96	58.42	12.25	7.00	2.96
D												
C												
B												

PG8. +879140108 EC NO: S2010-0695 DRWN:ATSEE 2010/02/11 CHKD:PTLIM 2004/12/08 APPR:MLONG 2010/06/05	QUALITY SYMBOLS	GENERAL TOLERANCES (UNLESS SPECIFIED)	DIMENSION STYLE	SCALE	DESIGN UNITS	THIRD ANGLE PROJECTION															
	$F_A=0$ $F_G=0$ $F_P=0$	<table border="1"> <tr> <th></th> <th>mm</th> <th>INCH</th> </tr> <tr> <td>4 PLACES</td> <td>± ---</td> <td>± ---</td> </tr> <tr> <td>3 PLACES</td> <td>± ---</td> <td>± ---</td> </tr> <tr> <td>2 PLACES</td> <td>± 0.20</td> <td>± ---</td> </tr> <tr> <td>1 PLACE</td> <td>± ---</td> <td>± ---</td> </tr> </table>		mm	INCH	4 PLACES	± ---	± ---	3 PLACES	± ---	± ---	2 PLACES	± 0.20	± ---	1 PLACE	± ---	± ---	MM ONLY	NTS	METRIC	
		mm	INCH																		
	4 PLACES	± ---	± ---																		
3 PLACES	± ---	± ---																			
2 PLACES	± 0.20	± ---																			
1 PLACE	± ---	± ---																			
DESCRIPTION	ANGULAR ± 3 °	DRAWN BY: KCHO DATE: 2004/11/05 CHECKED BY: PTLIM DATE: 2004/12/08 APPROVED BY: SCLOW DATE: 2004/12/10	TITLE: 2.54MM PITCH DUAL ROW HEADER SINGLE WAFER, T/H MOLEX INCORPORATED																		
REV: D7	DRAFT WHERE APPLICABLE MUST REMAIN WITHIN DIMENSIONS	SEE TABLE	MATERIAL NO.	DOCUMENT NO.	SHEET NO.																
			SIZE: A3	THIS DRAWING CONTAINS INFORMATION THAT IS PROPRIETARY TO MOLEX INCORPORATED AND SHOULD NOT BE USED WITHOUT WRITTEN PERMISSION																	

PART NO FOR TRAY PACKAGING	PART NO. FOR TUBE WITHOUT CAP PACKAGING	PART NO. FOR TUBE WITH CAP PACKAGING	PART NO. FOR TAPE & REEL WITHOUT CAP PACKAGING	PART NO. FOR TAPE & REEL WITH CAP PACKAGING	CKT SIZE	VOID POSITION	PLATING TYPE	DIMENSION				
								A	B	F	M	P
								F	87914-5011	-----	-----	-----
	87914-5021	-----	-----	-----	50	----	1	63.50	60.96	12.25	7.00	2.96
	87914-5012	-----	-----	-----	50	----	2	63.50	60.96	10.92	5.84	2.79
	87914-5022	-----	-----	-----	50	----	2	63.50	60.96	12.25	7.00	2.96
	87914-5013	-----	-----	-----	50	----	3	63.50	60.96	10.92	5.84	2.79
	87914-5023	-----	-----	-----	50	----	3	63.50	60.96	12.25	7.00	2.96
E	87914-5014	-----	-----	-----	50	----	4	63.50	60.96	10.92	5.84	2.79
	87914-5024	-----	-----	-----	50	----	4	63.50	60.96	12.25	7.00	2.96
	87914-5015	-----	-----	-----	50	----	5	63.50	60.96	10.92	5.84	2.79
	87914-5025	-----	-----	-----	50	----	5	63.50	60.96	12.25	7.00	2.96
	87914-5016	-----	-----	-----	50	----	6	63.50	60.96	10.92	5.84	2.79
	87914-5026	-----	-----	-----	50	----	6	63.50	60.96	12.25	7.00	2.96
D	87914-0002	-----	-----	-----	50	----	8	63.50	60.96	18.54	11.58	4.47

PG8. +879140108 EC NO: S2010-0695 DRWN:ATSEE 2010/02/11 CHKD:PTLIM 2004/12/08 APPR:MLONG 2010/06/05	QUALITY SYMBOLS	GENERAL TOLERANCES (UNLESS SPECIFIED) <table border="1"> <tr> <th></th> <th>mm</th> <th>INCH</th> </tr> <tr> <td>4 PLACES</td> <td>± ---</td> <td>± ---</td> </tr> <tr> <td>3 PLACES</td> <td>± ---</td> <td>± ---</td> </tr> <tr> <td>2 PLACES</td> <td>± 0.20</td> <td>± ---</td> </tr> <tr> <td>1 PLACE</td> <td>± ---</td> <td>± ---</td> </tr> </table>		mm	INCH	4 PLACES	± ---	± ---	3 PLACES	± ---	± ---	2 PLACES	± 0.20	± ---	1 PLACE	± ---	± ---	DIMENSION STYLE MM ONLY	SCALE NTS	DESIGN UNITS METRIC	THIRD ANGLE PROJECTION
			mm	INCH																	
	4 PLACES	± ---	± ---																		
	3 PLACES	± ---	± ---																		
2 PLACES	± 0.20	± ---																			
1 PLACE	± ---	± ---																			
$F_A = 0$ $F_G = 0$ $F_P = 0$	DRAWN BY KCHO	DATE 2004/11/05	TITLE 2.54MM PITCH DUAL ROW HEADER SINGLE WAFER, T/H																		
DESCRIPTION	CHECKED BY PTLIM	DATE 2004/12/08	MOLEX INCORPORATED																		
REV	APPROVED BY SCLOW	DATE 2004/12/10	MATERIAL NO. SEE TABLE	DOCUMENT NO. SD-87914-013	SHEET NO. 31 OF 46																

PART NO FOR BULK PACKAGING	PART NO. FOR TUBE WITHOUT CAP PACKAGING	PART NO. FOR TUBE WITH CAP PACKAGING	PART NO. FOR TAPE & REEL WITHOUT CAP PACKAGING	PART NO. FOR TAPE & REEL WITH CAP PACKAGING	CKT SIZE	VOID POSITION	PLATING TYPE	DIMENSION				
								A	B	F	M	P
								87914-5211	-----	-----	-----	-----
87914-5221	-----	-----	-----	-----	52	-----	1	66.04	63.50	12.25	7.00	2.96
87914-5212	-----	-----	-----	-----	52	-----	2	66.04	63.50	10.92	5.84	2.79
87914-5222	-----	-----	-----	-----	52	-----	2	66.04	63.50	12.25	7.00	2.96
87914-5213	-----	-----	-----	-----	52	-----	3	66.04	63.50	10.92	5.84	2.79
87914-5223	-----	-----	-----	-----	52	-----	3	66.04	63.50	12.25	7.00	2.96
87914-5214	-----	-----	-----	-----	52	-----	4	66.04	63.50	10.92	5.84	2.79
87914-5224	-----	-----	-----	-----	52	-----	4	66.04	63.50	12.25	7.00	2.96
87914-5215	-----	-----	-----	-----	52	-----	5	66.04	63.50	10.92	5.84	2.79
87914-5225	-----	-----	-----	-----	52	-----	5	66.04	63.50	12.25	7.00	2.96
87914-5216	-----	-----	-----	-----	52	-----	6	66.04	63.50	10.92	5.84	2.79
87914-5226	-----	-----	-----	-----	52	-----	6	66.04	63.50	12.25	7.00	2.96

PG8. +879140108 EC NO: S2010-0695 DRWN:ATSEE 2010/02/11 CHKD:PTLIM 2004/12/08 APPR:MLONG 2010/06/05 D7	QUALITY SYMBOLS $F_A=0$ $F_C=0$ $F_B=0$	GENERAL TOLERANCES (UNLESS SPECIFIED) mm INCH 4 PLACES \pm --- \pm --- 3 PLACES \pm --- \pm --- 2 PLACES ± 0.20 \pm --- 1 PLACE \pm --- \pm --- ANGULAR $\pm 3^\circ$	DIMENSION STYLE MM ONLY DRAWN BY DATE KCHO 2004/11/05 CHECKED BY DATE PTLIM 2004/12/08 APPROVED BY DATE SCLOW 2004/12/10	SCALE NTS	DESIGN UNITS METRIC	THIRD ANGLE PROJECTION	TITLE 2.54MM PITCH DUAL ROW HEADER SINGLE WAFER, T/H
	MATERIAL NO.	DOCUMENT NO.	SEE TABLE	MOLEX INCORPORATED	SHEET NO. 32 OF 46		
	DRAFT WHERE APPLICABLE MUST REMAIN WITHIN DIMENSIONS				SD-87914-013		
	SIZE A3 THIS DRAWING CONTAINS INFORMATION THAT IS PROPRIETARY TO MOLEX INCORPORATED AND SHOULD NOT BE USED WITHOUT WRITTEN PERMISSION						

	10	9	8	7	6	5	4	3	2	1			
	PART NO FOR BULK PACKAGING	PART NO. FOR TUBE WITHOUT CAP PACKAGING	PART NO. FOR TUBE WITH CAP PACKAGING	PART NO. FOR TAPE & REEL WITHOUT CAP PACKAGING	PART NO. FOR TAPE & REEL WITH CAP PACKAGING	CKT SIZE	VOID POSITION	PLATING TYPE	DIMENSION				
									A	B	F	M	P
F	87914-5611	-----	-----	-----	-----	56	----	1	71.12	68.58	10.92	5.84	2.79
	87914-5621	-----	-----	-----	-----	56	----	1	71.12	68.58	12.25	7.00	2.96
	87914-5612	-----	-----	-----	-----	56	----	2	71.12	68.58	10.92	5.84	2.79
	87914-5622	-----	-----	-----	-----	56	----	2	71.12	68.58	12.25	7.00	2.96
	87914-5613	-----	-----	-----	-----	56	----	3	71.12	68.58	10.92	5.84	2.79
	87914-5623	-----	-----	-----	-----	56	----	3	71.12	68.58	12.25	7.00	2.96
E	87914-5614	-----	-----	-----	-----	56	----	4	71.12	68.58	10.92	5.84	2.79
	87914-5624	-----	-----	-----	-----	56	----	4	71.12	68.58	12.25	7.00	2.96
	87914-5615	-----	-----	-----	-----	56	----	5	71.12	68.58	10.92	5.84	2.79
	87914-5625	-----	-----	-----	-----	56	----	5	71.12	68.58	12.25	7.00	2.96
	87914-5616	-----	-----	-----	-----	56	----	6	71.12	68.58	10.92	5.84	2.79
	87914-5626	-----	-----	-----	-----	56	----	6	71.12	68.58	12.25	7.00	2.96
D													
C													
B													

PG8. +879140108 EC NO: S2010-0695 DRWN:ATSEE 2010/02/11 CHKD:PTLIM 2004/12/08 APPR:MLONG 2010/06/05	QUALITY SYMBOLS	GENERAL TOLERANCES (UNLESS SPECIFIED)	DIMENSION STYLE	SCALE	DESIGN UNITS	THIRD ANGLE PROJECTION	
	$F_{\Delta} = 0$	4 PLACES	MM ONLY	NTS	METRIC		
	$F_{\square} = 0$	3 PLACES	mm INCH	DRAWN BY	DATE	TITLE	
	$F_{\phi} = 0$	2 PLACES		DATE	DATE		
	1 PLACE	ANGULAR $\pm 3^{\circ}$	PTLIM	2004/12/08	2.54MM PITCH DUAL ROW HEADER SINGLE WAFER, T/H		
			APPROVED BY	DATE	MOLEX INCORPORATED		
			SCLOW	2004/12/10			
			MATERIAL NO.	DOCUMENT NO.			
		DRAFT WHERE APPLICABLE MUST REMAIN WITHIN DIMENSIONS	SEE TABLE		SD-87914-013		
			SIZE	THIS DRAWING CONTAINS INFORMATION THAT IS PROPRIETARY TO MOLEX INCORPORATED AND SHOULD NOT BE USED WITHOUT WRITTEN PERMISSION			
			A3				

	10	9	8	7	6	5	4	3	2	1			
	PART NO FOR BULK PACKAGING	PART NO. FOR TUBE WITHOUT CAP PACKAGING	PART NO. FOR TUBE WITH CAP PACKAGING	PART NO. FOR TAPE & REEL WITHOUT CAP PACKAGING	PART NO. FOR TAPE & REEL WITH CAP PACKAGING	CKT SIZE	VOID POSITION	PLATING TYPE	DIMENSION				
								A	B	F	M	P	
F	87914-5811	-----	-----	-----	-----	58	----	1	73.66	71.12	10.92	5.84	2.79
	87914-5821	-----	-----	-----	-----	58	----	1	73.66	71.12	12.25	7.00	2.96
	87914-5812	-----	-----	-----	-----	58	----	2	73.66	71.12	10.92	5.84	2.79
	87914-5822	-----	-----	-----	-----	58	----	2	73.66	71.12	12.25	7.00	2.96
	87914-5813	-----	-----	-----	-----	58	----	3	73.66	71.12	10.92	5.84	2.79
	87914-5823	-----	-----	-----	-----	58	----	3	73.66	71.12	12.25	7.00	2.96
E	87914-5814	-----	-----	-----	-----	58	----	4	73.66	71.12	10.92	5.84	2.79
	87914-5824	-----	-----	-----	-----	58	----	4	73.66	71.12	12.25	7.00	2.96
	87914-5815	-----	-----	-----	-----	58	----	5	73.66	71.12	10.92	5.84	2.79
	87914-5825	-----	-----	-----	-----	58	----	5	73.66	71.12	12.25	7.00	2.96
	87914-5816	-----	-----	-----	-----	58	----	6	73.66	71.12	10.92	5.84	2.79
	87914-5826	-----	-----	-----	-----	58	----	6	73.66	71.12	12.25	7.00	2.96
D													
C													
B													

PG8. +879140108 EC NO: S2010-0695 DRWN:ATSEE 2010/02/11 CHKD:PTLIM 2004/12/08 APPR:MLONG 2010/06/05 D7	QUALITY SYMBOLS $F_A=0$ $F_G=0$ $F_P=0$	GENERAL TOLERANCES (UNLESS SPECIFIED) <table border="1"> <tr><th colspan="2">mm</th><th>INCH</th></tr> <tr><td>4 PLACES</td><td>± ---</td><td>± ---</td></tr> <tr><td>3 PLACES</td><td>± ---</td><td>± ---</td></tr> <tr><td>2 PLACES</td><td>± 0.20</td><td>± ---</td></tr> <tr><td>1 PLACE</td><td>± ---</td><td>± ---</td></tr> </table>	mm		INCH	4 PLACES	± ---	± ---	3 PLACES	± ---	± ---	2 PLACES	± 0.20	± ---	1 PLACE	± ---	± ---	DIMENSION STYLE MM ONLY	SCALE NTS	DESIGN UNITS METRIC	THIRD ANGLE PROJECTION
	mm		INCH																		
	4 PLACES	± ---	± ---																		
	3 PLACES	± ---	± ---																		
2 PLACES	± 0.20	± ---																			
1 PLACE	± ---	± ---																			
DRAWN BY KCHO	DATE 2004/11/05	TITLE 2.54MM PITCH DUAL ROW HEADER SINGLE WAFER, T/H																			
CHECKED BY PTLIM	DATE 2004/12/08	MOLEX INCORPORATED																			
APPROVED BY SCLOW	DATE 2004/12/10	MATERIAL NO. SEE TABLE	DOCUMENT NO. SD-87914-013	SHEET NO. 35 OF 46																	

PART NO FOR BULK PACKAGING	PART NO. FOR TUBE WITHOUT CAP PACKAGING	PART NO. FOR TUBE WITH CAP PACKAGING	PART NO. FOR TAPE & REEL WITHOUT CAP PACKAGING	PART NO. FOR TAPE & REEL WITH CAP PACKAGING	CKT SIZE	VOID POSITION	PLATING TYPE	DIMENSION				
								A	B	F	M	P
F	87914-6011	-----	-----	-----	60	----	1	76.20	73.66	10.92	5.84	2.79
	87914-6021	-----	-----	-----	60	----	1	76.20	73.66	12.25	7.00	2.96
	87914-6012	-----	-----	-----	60	----	2	76.20	73.66	10.92	5.84	2.79
	87914-6022	-----	-----	-----	60	----	2	76.20	73.66	12.25	7.00	2.96
	87914-6013	-----	-----	-----	60	----	3	76.20	73.66	10.92	5.84	2.79
	87914-6023	-----	-----	-----	60	----	3	76.20	73.66	12.25	7.00	2.96
E	87914-6014	-----	-----	-----	60	----	4	76.20	73.66	10.92	5.84	2.79
	87914-6024	-----	-----	-----	60	----	4	76.20	73.66	12.25	7.00	2.96
	87914-6015	-----	-----	-----	60	----	5	76.20	73.66	10.92	5.84	2.79
	87914-6025	-----	-----	-----	60	----	5	76.20	73.66	12.25	7.00	2.96
	87914-6016	-----	-----	-----	60	----	6	76.20	73.66	10.92	5.84	2.79
	87914-6026	-----	-----	-----	60	----	6	76.20	73.66	12.25	7.00	2.96
D												
C												
B												

PG8. +879140108 EC NO: S2010-0695 DRWN:ATSEE 2010/02/11 CHKD:PTLIM 2004/12/08 APPR:MLONG 2010/06/05 REV D7	QUALITY SYMBOLS	GENERAL TOLERANCES (UNLESS SPECIFIED)	DIMENSION STYLE	SCALE	DESIGN UNITS	THIRD ANGLE PROJECTION																
	$F_A=0$ $F_C=0$ $F_P=0$	<table border="1"> <tr><th colspan="2">mm</th><th>INCH</th></tr> <tr><td>4 PLACES</td><td>± ---</td><td>± ---</td></tr> <tr><td>3 PLACES</td><td>± ---</td><td>± ---</td></tr> <tr><td>2 PLACES</td><td>± 0.20</td><td>± ---</td></tr> <tr><td>1 PLACE</td><td>± ---</td><td>± ---</td></tr> </table>	mm		INCH	4 PLACES	± ---	± ---	3 PLACES	± ---	± ---	2 PLACES	± 0.20	± ---	1 PLACE	± ---	± ---	MM ONLY	NTS	METRIC		
	mm		INCH																			
	4 PLACES	± ---	± ---																			
3 PLACES	± ---	± ---																				
2 PLACES	± 0.20	± ---																				
1 PLACE	± ---	± ---																				
	ANGULAR ± 3 °	<table border="1"> <tr><th>DRAWN BY</th><th>DATE</th><th>TITLE</th></tr> <tr><td>KCHO</td><td>2004/11/05</td><td rowspan="3">2.54MM PITCH DUAL ROW HEADER SINGLE WAFER, T/H</td></tr> <tr><th>CHECKED BY</th><th>DATE</th></tr> <tr><td>PTLIM</td><td>2004/12/08</td></tr> <tr><th>APPROVED BY</th><th>DATE</th><td></td></tr> <tr><td>SCLOW</td><td>2004/12/10</td><td></td></tr> </table>	DRAWN BY	DATE	TITLE	KCHO	2004/11/05	2.54MM PITCH DUAL ROW HEADER SINGLE WAFER, T/H	CHECKED BY	DATE	PTLIM	2004/12/08	APPROVED BY	DATE		SCLOW	2004/12/10					MOLEX INCORPORATED
DRAWN BY	DATE	TITLE																				
KCHO	2004/11/05	2.54MM PITCH DUAL ROW HEADER SINGLE WAFER, T/H																				
CHECKED BY	DATE																					
PTLIM	2004/12/08																					
APPROVED BY	DATE																					
SCLOW	2004/12/10																					
	DRAFT WHERE APPLICABLE MUST REMAIN WITHIN DIMENSIONS	SEE TABLE			DOCUMENT NO.	SHEET NO.																
			SIZE A3		SD-87914-013	36 OF 46																

PART NO FOR BULK PACKAGING	PART NO. FOR TUBE WITHOUT CAP PACKAGING	PART NO. FOR TUBE WITH CAP PACKAGING	PART NO. FOR TAPE & REEL WITHOUT CAP PACKAGING	PART NO. FOR TAPE & REEL WITH CAP PACKAGING	CKT SIZE	VOID POSITION	PLATING TYPE	DIMENSION				
								A	B	F	M	P
F	87914-6211	-----	-----	-----	62	----	1	78.74	76.20	10.92	5.84	2.79
	87914-6221	-----	-----	-----	62	----	1	78.74	76.20	12.25	7.00	2.96
	87914-6212	-----	-----	-----	62	----	2	78.74	76.20	10.92	5.84	2.79
	87914-6222	-----	-----	-----	62	----	2	78.74	76.20	12.25	7.00	2.96
	87914-6213	-----	-----	-----	62	----	3	78.74	76.20	10.92	5.84	2.79
	87914-6223	-----	-----	-----	62	----	3	78.74	76.20	12.25	7.00	2.96
E	87914-6214	-----	-----	-----	62	----	4	78.74	76.20	10.92	5.84	2.79
	87914-6224	-----	-----	-----	62	----	4	78.74	76.20	12.25	7.00	2.96
	87914-6215	-----	-----	-----	62	----	5	78.74	76.20	10.92	5.84	2.79
	87914-6225	-----	-----	-----	62	----	5	78.74	76.20	12.25	7.00	2.96
	87914-6216	-----	-----	-----	62	----	6	78.74	76.20	10.92	5.84	2.79
	87914-6226	-----	-----	-----	62	----	6	78.74	76.20	12.25	7.00	2.96
D												
C												
B												

PG8. +879140108 EC NO: S2010-0695 DRWN:ATSEE 2010/02/11 CHKD:PTLIM 2004/12/08 APPR:MLONG 2010/06/05 D7	QUALITY SYMBOLS $\nabla_A = 0$ $\nabla_C = 0$ $\nabla_P = 0$	GENERAL TOLERANCES (UNLESS SPECIFIED) <table border="1"> <tr><th colspan="2">mm</th><th>INCH</th></tr> <tr><td>4 PLACES</td><td>± ---</td><td>± ---</td></tr> <tr><td>3 PLACES</td><td>± ---</td><td>± ---</td></tr> <tr><td>2 PLACES</td><td>± 0.20</td><td>± ---</td></tr> <tr><td>1 PLACE</td><td>± ---</td><td>± ---</td></tr> </table>	mm		INCH	4 PLACES	± ---	± ---	3 PLACES	± ---	± ---	2 PLACES	± 0.20	± ---	1 PLACE	± ---	± ---	DIMENSION STYLE MM ONLY DRAWN BY: KCHO CHECKED BY: PTLIM APPROVED BY: SCLOW DATE: 2004/11/05 DATE: 2004/12/08 DATE: 2004/12/10	SCALE: NTS DESIGN UNITS: METRIC THIRD ANGLE PROJECTION	TITLE: 2.54MM PITCH DUAL ROW HEADER SINGLE WAFER, T/H MOLEX INCORPORATED DOCUMENT NO.: SD-87914-013 SHEET NO.: 37 OF 46
	mm		INCH																	
	4 PLACES	± ---	± ---																	
	3 PLACES	± ---	± ---																	
2 PLACES	± 0.20	± ---																		
1 PLACE	± ---	± ---																		
	DRAFT WHERE APPLICABLE MUST REMAIN WITHIN DIMENSIONS	MATERIAL NO.: SEE TABLE	THIS DRAWING CONTAINS INFORMATION THAT IS PROPRIETARY TO MOLEX INCORPORATED AND SHOULD NOT BE USED WITHOUT WRITTEN PERMISSION																	
			SIZE: A3																	

PART NO FOR BULK PACKAGING	PART NO. FOR TUBE WITHOUT CAP PACKAGING	PART NO. FOR TUBE WITH CAP PACKAGING	PART NO. FOR TAPE & REEL WITHOUT CAP PACKAGING	PART NO. FOR TAPE & REEL WITH CAP PACKAGING	CKT SIZE	VOID POSITION	PLATING TYPE	DIMENSION					
								A	B	F	M	P	
								F	87914-6411	-----	-----	-----	-----
	87914-6421	-----	-----	-----	-----	64	----	1	81.28	78.74	12.25	7.00	2.96
	87914-6412	-----	-----	-----	-----	64	----	2	81.28	78.74	10.92	5.84	2.79
	87914-6422	-----	-----	-----	-----	64	----	2	81.28	78.74	12.25	7.00	2.96
	87914-6413	-----	-----	-----	-----	64	----	3	81.28	78.74	10.92	5.84	2.79
	87914-6423	-----	-----	-----	-----	64	----	3	81.28	78.74	12.25	7.00	2.96
E	87914-6414	-----	-----	-----	-----	64	----	4	81.28	78.74	10.92	5.84	2.79
	87914-6424	-----	-----	-----	-----	64	----	4	81.28	78.74	12.25	7.00	2.96
	87914-6415	-----	-----	-----	-----	64	----	5	81.28	78.74	10.92	5.84	2.79
	87914-6425	-----	-----	-----	-----	64	----	5	81.28	78.74	12.25	7.00	2.96
	87914-6416	-----	-----	-----	-----	64	----	6	81.28	78.74	10.92	5.84	2.79
	87914-6426	-----	-----	-----	-----	64	----	6	81.28	78.74	12.25	7.00	2.96
D													
C													
B													

PG8. +879140108 EC NO: S2010-0695 DRWN:ATSEE 2010/02/11 CHKD:PTLIM 2004/12/08 APPR:MLONG 2010/06/05 D7	QUALITY SYMBOLS $F_A = 0$ $F_G = 0$ $F_P = 0$	GENERAL TOLERANCES (UNLESS SPECIFIED) <table border="1"> <tr> <td></td> <th>mm</th> <th>INCH</th> </tr> <tr> <td>4 PLACES</td> <td>± ---</td> <td>± ---</td> </tr> <tr> <td>3 PLACES</td> <td>± ---</td> <td>± ---</td> </tr> <tr> <td>2 PLACES</td> <td>± 0.20</td> <td>± ---</td> </tr> <tr> <td>1 PLACE</td> <td>± ---</td> <td>± ---</td> </tr> </table> ANGULAR ± 3°		mm	INCH	4 PLACES	± ---	± ---	3 PLACES	± ---	± ---	2 PLACES	± 0.20	± ---	1 PLACE	± ---	± ---	DIMENSION STYLE MM ONLY	SCALE NTS	DESIGN UNITS METRIC	THIRD ANGLE PROJECTION 2.54MM PITCH DUAL ROW HEADER SINGLE WAFER, T/H  MOLEX INCORPORATED
				mm	INCH																
			4 PLACES	± ---	± ---																
			3 PLACES	± ---	± ---																
			2 PLACES	± 0.20	± ---																
1 PLACE	± ---	± ---																			
DRAWN BY: KCHO CHECKED BY: PTLIM APPROVED BY: SCLOW	DATE: 2004/11/05 DATE: 2004/12/08 DATE: 2004/12/10	TITLE		MATERIAL NO.	SHEET NO.																
DRAFT WHERE APPLICABLE MUST REMAIN WITHIN DIMENSIONS		SEE TABLE		SD-87914-013																	
THIS DRAWING CONTAINS INFORMATION THAT IS PROPRIETARY TO MOLEX INCORPORATED AND SHOULD NOT BE USED WITHOUT WRITTEN PERMISSION																					

PART NO FOR BULK PACKAGING	PART NO. FOR TUBE WITHOUT CAP PACKAGING	PART NO. FOR TUBE WITH CAP PACKAGING	PART NO. FOR TAPE & REEL WITHOUT CAP PACKAGING	PART NO. FOR TAPE & REEL WITH CAP PACKAGING	CKT SIZE	VOID POSITION	PLATING TYPE	DIMENSION				
								A	B	F	M	P
F	87914-6611	-----	-----	-----	66	-----	1	83.82	81.28	10.92	5.84	2.79
	87914-6621	-----	-----	-----	66	-----	1	83.82	81.28	12.25	7.00	2.96
	87914-6612	-----	-----	-----	66	-----	2	83.82	81.28	10.92	5.84	2.79
	87914-6622	-----	-----	-----	66	-----	2	83.82	81.28	12.25	7.00	2.96
	87914-6613	-----	-----	-----	66	-----	3	83.82	81.28	10.92	5.84	2.79
	87914-6623	-----	-----	-----	66	-----	3	83.82	81.28	12.25	7.00	2.96
E	87914-6614	-----	-----	-----	66	-----	4	83.82	81.28	10.92	5.84	2.79
	87914-6624	-----	-----	-----	66	-----	4	83.82	81.28	12.25	7.00	2.96
	87914-6615	-----	-----	-----	66	-----	5	83.82	81.28	10.92	5.84	2.79
	87914-6625	-----	-----	-----	66	-----	5	83.82	81.28	12.25	7.00	2.96
	87914-6616	-----	-----	-----	66	-----	6	83.82	81.28	10.92	5.84	2.79
	87914-6626	-----	-----	-----	66	-----	6	83.82	81.28	12.25	7.00	2.96
D												
C												
B												

PG8. +879140108 EC NO: S2010-0695 DRWN:ATSEE 2010/02/11 CHKD:PTLIM 2004/12/08 APPR:MLONG 2010/06/05 D7	QUALITY SYMBOLS $F_A=0$ $F_G=0$ $F_P=0$	GENERAL TOLERANCES (UNLESS SPECIFIED)		DIMENSION STYLE	SCALE	DESIGN UNITS	THIRD ANGLE PROJECTION	
				MM ONLY	NTS	METRIC		
				mm	INCH	DRAWN BY	DATE	TITLE
				4 PLACES \pm ---	\pm ---	KCHO	2004/11/05	2.54MM PITCH DUAL ROW HEADER SINGLE WAFER, T/H MOLEX INCORPORATED
		3 PLACES \pm ---	\pm ---	CHECKED BY	DATE	DOCUMENT NO. SD-87914-013 SHEET NO. 39 OF 46		
		2 PLACES \pm 0.20	\pm ---	PTLIM	2004/12/08			
		1 PLACE \pm ---	\pm ---	APPROVED BY	DATE			
		ANGULAR \pm 3°		SLOW	2004/12/10			
		DRAFT WHERE APPLICABLE MUST REMAIN WITHIN DIMENSIONS		MATERIAL NO.				
				SEE TABLE				
				SIZE A3	THIS DRAWING CONTAINS INFORMATION THAT IS PROPRIETARY TO MOLEX INCORPORATED AND SHOULD NOT BE USED WITHOUT WRITTEN PERMISSION			

PART NO FOR BULK PACKAGING	PART NO. FOR TUBE WITHOUT CAP PACKAGING	PART NO. FOR TUBE WITH CAP PACKAGING	PART NO. FOR TAPE & REEL WITHOUT CAP PACKAGING	PART NO. FOR TAPE & REEL WITH CAP PACKAGING	CKT SIZE	VOID POSITION	PLATING TYPE	DIMENSION				
								A	B	F	M	P
								F	87914-7011	-----	-----	-----
	87914-7021	-----	-----	-----	70	----	1	88.90	86.36	12.25	7.00	2.96
	87914-7012	-----	-----	-----	70	----	2	88.90	86.36	10.92	5.84	2.79
	87914-7022	-----	-----	-----	70	----	2	88.90	86.36	12.25	7.00	2.96
	87914-7013	-----	-----	-----	70	----	3	88.90	86.36	10.92	5.84	2.79
	87914-7023	-----	-----	-----	70	----	3	88.90	86.36	12.25	7.00	2.96
E	87914-7014	-----	-----	-----	70	----	4	88.90	86.36	10.92	5.84	2.79
	87914-7024	-----	-----	-----	70	----	4	88.90	86.36	12.25	7.00	2.96
	87914-7015	-----	-----	-----	70	----	5	88.90	86.36	10.92	5.84	2.79
	87914-7025	-----	-----	-----	70	----	5	88.90	86.36	12.25	7.00	2.96
	87914-7016	-----	-----	-----	70	----	6	88.90	86.36	10.92	5.84	2.79
	87914-7026	-----	-----	-----	70	----	6	88.90	86.36	12.25	7.00	2.96
D												
C												
B												

PG8. +879140108 EC NO: S2010-0695 DRW:NATSEE 2010/02/11 CHK:DPTLM 2004/12/08 APPR:MLONG 2010/06/05 D7	QUALITY SYMBOLS	GENERAL TOLERANCES (UNLESS SPECIFIED)	DIMENSION STYLE	SCALE	DESIGN UNITS	THIRD ANGLE PROJECTION		
	$F_A=0$ $F_C=0$ $F_P=0$	mm	INCH	MM ONLY	NTS	METRIC		
		4 PLACES	± ---	± ---	DRAWN BY	DATE		TITLE
		3 PLACES	± ---	± ---	KCHO	2004/11/05		2.54MM PITCH DUAL ROW HEADER SINGLE WAFER, T/H MOLEX INCORPORATED
	2 PLACES	± 0.20	± ---	CHECKED BY	DATE			
	1 PLACE	± ---	± ---	PTLIM	2004/12/08			
ANGULAR ± 3 °			APPROVED BY	DATE				
DRAFT WHERE APPLICABLE MUST REMAIN WITHIN DIMENSIONS			SCLOW	2004/12/10				
			MATERIAL NO.	DOCUMENT NO.	SHEET NO.			
			SEE TABLE	SD-87914-013	41 OF 46			

10		9		8		7		6		5		4		3		2		1	
PART NO FOR BULK PACKAGING	PART NO. FOR TUBE WITHOUT CAP PACKAGING	PART NO. FOR TUBE WITH CAP PACKAGING	PART NO. FOR TAPE & REEL WITHOUT CAP PACKAGING	PART NO. FOR TAPE & REEL WITH CAP PACKAGING	CKT SIZE	VOID POSITION	PLATING TYPE	DIMENSION											
								A	B	F	M	P							
F	87914-7411	-----	-----	-----	74	----	1	93.98	91.44	10.92	5.84	2.79							
	87914-7421	-----	-----	-----	74	----	1	93.98	91.44	12.25	7.00	2.96							
	87914-7412	-----	-----	-----	74	----	2	93.98	91.44	10.92	5.84	2.79							
	87914-7422	-----	-----	-----	74	----	2	93.98	91.44	12.25	7.00	2.96							
	87914-7413	-----	-----	-----	74	----	3	93.98	91.44	10.92	5.84	2.79							
	87914-7423	-----	-----	-----	74	----	3	93.98	91.44	12.25	7.00	2.96							
E	87914-7414	-----	-----	-----	74	----	4	93.98	91.44	10.92	5.84	2.79							
	87914-7424	-----	-----	-----	74	----	4	93.98	91.44	12.25	7.00	2.96							
	87914-7415	-----	-----	-----	74	----	5	93.98	91.44	10.92	5.84	2.79							
	87914-7425	-----	-----	-----	74	----	5	93.98	91.44	12.25	7.00	2.96							
	87914-7416	-----	-----	-----	74	----	6	93.98	91.44	10.92	5.84	2.79							
	87914-7426	-----	-----	-----	74	----	6	93.98	91.44	12.25	7.00	2.96							
D																			
C																			
B																			

PG8, +879140108 EC NO: S2010-0695 DRW:ATSEE 2010/02/11 CHKD:PTLIM 2004/12/08 APPR:MLONG 2010/06/05	DESCRIPTION REV D7	QUALITY SYMBOLS $F_A=0$ $F_G=0$ $F_P=0$	GENERAL TOLERANCES (UNLESS SPECIFIED)		DIMENSION STYLE MM ONLY		SCALE NTS	DESIGN UNITS METRIC	THIRD ANGLE PROJECTION	
			mm INCH	DRAWN BY KCHO	DATE 2004/11/05	2.54MM PITCH DUAL ROW HEADER SINGLE WAFER, T/H MOLEX INCORPORATED				
4 PLACES ± --- ± --- 3 PLACES ± --- ± --- 2 PLACES ± 0.20 ± --- 1 PLACE ± --- ± ---	CHECKED BY PTLIM	DATE 2004/12/08								
ANGULAR ± 3 °	APPROVED BY SCLOW	DATE 2004/12/10								
DRAFT WHERE APPLICABLE MUST REMAIN WITHIN DIMENSIONS			MATERIAL NO. SEE TABLE	DOCUMENT NO. SD-87914-013	SHEET NO. 43 OF 46					
THIS DRAWING CONTAINS INFORMATION THAT IS PROPRIETARY TO MOLEX INCORPORATED AND SHOULD NOT BE USED WITHOUT WRITTEN PERMISSION										

	10		9		8		7		6		5		4		3		2		1	
	PART NO FOR BULK PACKAGING	PART NO. FOR TUBE WITHOUT CAP PACKAGING	PART NO. FOR TUBE WITH CAP PACKAGING	PART NO. FOR TAPE & REEL WITHOUT CAP PACKAGING	PART NO. FOR TAPE & REEL WITH CAP PACKAGING	CKT SIZE	VOID POSITION	PLATING TYPE	DIMENSION											
									A	B	F	M	P							
F	87914-7811	-----	-----	-----	-----	78	----	1	99.06	96.52	10.92	5.84	2.79							
	87914-7821	-----	-----	-----	-----	78	----	1	99.06	96.52	12.25	7.00	2.96							
	87914-7812	-----	-----	-----	-----	78	----	2	99.06	96.52	10.92	5.84	2.79							
	87914-7822	-----	-----	-----	-----	78	----	2	99.06	96.52	12.25	7.00	2.96							
	87914-7813	-----	-----	-----	-----	78	----	3	99.06	96.52	10.92	5.84	2.79							
	87914-7823	-----	-----	-----	-----	78	----	3	99.06	96.52	12.25	7.00	2.96							
E	87914-7814	-----	-----	-----	-----	78	----	4	99.06	96.52	10.92	5.84	2.79							
	87914-7824	-----	-----	-----	-----	78	----	4	99.06	96.52	12.25	7.00	2.96							
	87914-7815	-----	-----	-----	-----	78	----	5	99.06	96.52	10.92	5.84	2.79							
	87914-7825	-----	-----	-----	-----	78	----	5	99.06	96.52	12.25	7.00	2.96							
	87914-7816	-----	-----	-----	-----	78	----	6	99.06	96.52	10.92	5.84	2.79							
	87914-7826	-----	-----	-----	-----	78	----	6	99.06	96.52	12.25	7.00	2.96							
D																				
C																				
B																				

fb_frame_A3_P_AM_T
Rev. F 2009/06/18

PG8. +879140108 EC NO: S2010-0695 DRWN:ATSEE 2010/02/11 CHKD:PTLIM 2004/12/08 APPR:MLONG 2010/06/05	DESCRIPTION REV D7	QUALITY SYMBOLS $F_A=0$ $F_C=0$ $F_P=0$	GENERAL TOLERANCES (UNLESS SPECIFIED) <table border="1"> <tr><td></td><td>mm</td><td>INCH</td></tr> <tr><td>4 PLACES</td><td>± ---</td><td>± ---</td></tr> <tr><td>3 PLACES</td><td>± ---</td><td>± ---</td></tr> <tr><td>2 PLACES</td><td>± 0.20</td><td>± ---</td></tr> <tr><td>1 PLACE</td><td>± ---</td><td>± ---</td></tr> </table>		mm	INCH	4 PLACES	± ---	± ---	3 PLACES	± ---	± ---	2 PLACES	± 0.20	± ---	1 PLACE	± ---	± ---	DIMENSION STYLE MM ONLY	SCALE NTS	DESIGN UNITS METRIC	THIRD ANGLE PROJECTION	DRAWN BY KCHO	DATE 2004/11/05	TITLE 2.54MM PITCH DUAL ROW HEADER SINGLE WAFER, T/H MOLEX INCORPORATED
			mm	INCH																					
		4 PLACES	± ---	± ---																					
		3 PLACES	± ---	± ---																					
2 PLACES	± 0.20	± ---																							
1 PLACE	± ---	± ---																							
APPROVED BY SCLOW	DATE 2004/12/10	MATERIAL NO. SEE TABLE	DOCUMENT NO. SD-87914-013	SHEET NO. 45 OF 46																					
DRAFT WHERE APPLICABLE MUST REMAIN WITHIN DIMENSIONS		SIZE A3	THIS DRAWING CONTAINS INFORMATION THAT IS PROPRIETARY TO MOLEX INCORPORATED AND SHOULD NOT BE USED WITHOUT WRITTEN PERMISSION																						

