

Single-phase and Three-phase SSRs Ideal for Frequent Switching Applications Under Heater Load

- Slim models available for single-phase and three-phase output
- Lower cost based on new modular construction
- Optimum heat sinks attach to models without built-in heat sinks
- Models for 15 to 45 A are available
- DIN-rail mounting possible (when using the Y92B-P50) in addition to screw mounting
- Conforms to UL, CSA, and CE



This product was manufactured at OMRON Takeo. OMRON Takeo has obtained approvals from international certification bodies for its quality system and environmental control system.

## Ordering Information

### ■ CONTACTORS WITH BUILT-IN HEAT SINKS

Number of phases	Number of elements	Zero-cross function	Main circuit voltage	Applicable heater capacity (with Class-1 AC resistive load)	Part number
3	3	Yes	100 to 240 VAC	5.1 kW max. (15 A)	G3PB-215B-3-VD
	2				G3PB-215B-2-VD
	3			8.6 kW max. (25 A)	G3PB-225B-3-VD
	2				G3PB-225B-2-VD
	3			12.1 kW max. (35 A)	G3PB-235B-3-VD
	2				G3PB-235B-2-VD
	3			15.5 kW max. (45 A)	G3PB-245B-3-VD
	2				G3PB-245B-2-VD

(This table continues on the next page.)

Ordering Information - continued from previous page

Number of phases	Number of elements	Zero-cross function	Main circuit voltage	Applicable heater capacity (with Class-1 AC resistive load)	Part number
3	3	Yes	200 to 400 VAC	10.3 kW max. (15 A)	G3PB-415B-3-VD
	2				G3PB-415B-2-VD
	3			17.3 kW max. (25 A)	G3PB-425B-3-VD
	2				G3PB-425B-2-VD
	3			24.2 kW max. (35 A)	G3PB-435B-3-VD
	2				G3PB-435B-2-VD
	3			31.1 kW max. (45 A)	G3PB-445B-3-VD
	2				G3PB-445B-2-VD

### ■ CONTACTORS WITHOUT BUILT-IN HEAT SINKS

Number of phases	Number of elements	Zero-cross function	Main circuit voltage	Rated carry current	Part number
3	3	Yes	100 to 240 VAC	15 A max.	G3PB-215B-3H-VD
	2				G3PB-215B-2H-VD
	3			25 A max.	G3PB-225B-3H-VD
	2				G3PB-225B-2H-VD
	3			35 A max.	G3PB-235B-3H-VD
	2				G3PB-235B-2H-VD
	3			45 A max.	G3PB-245B-3H-VD
	2				G3PB-245B-2H-VD
	3		200 to 400 VAC	15 A max.	G3PB-415B-3H-VD
	2				G3PB-415B-2H-VD
	3			25 A max.	G3PB-425B-3H-VD
	2				G3PB-425B-2H-VD
	3			35 A max.	G3PB-435B-3H-VD
	2				G3PB-435B-2H-VD
	3			45 A max.	G3PB-445B-3H-VD
	2				G3PB-445B-2H-VD

Note: The load current vs. ambient temperature characteristics of the Unit vary with the heat radiation of the Unit. Refer to *Engineering Data* for details.

### ■ SINGLE-PHASE SOLID-STATE RELAYS

No. of phases	Zero-cross function	Main circuit voltage	Applicable heater capacity (resistive load: Class-1 AC)	Part number
Single-phase	Yes	100 to 240 VAC	3.6 kW max. (15 A)	G3PB-215B-VD
			6 kW max. (25 A)	G3PB-225B-VD
			8.4 kW max. (35 A)	G3PB-235B-VD
			10.8 kW max. (45 A)	G3PB-245B-VD

### ■ HEAT SINKS

Heat resistance (°C/W)	Part number
1.67	Y92B-P50
1.01	Y92B-P100
0.63	Y92B-P150
0.43	Y92B-P200
0.36	Y92B-P250

## ■ ACCESSORIES (ORDER SEPARATELY)

Mounting rail	50 cm (1) x 7.3 mm (t)	PFP-50N
	1 m (1) x 7.3 mm (t)	PFP-100N
	1 m (1) x 16 mm (t)	PFP-100N2

## Specifications for Contactors

### ■ RATINGS (AT AN AMBIENT TEMPERATURE OF 25°C)

#### Operating Circuit (Common)

Item	Common
Rated operating voltage	12 to 24 VDC
Operating voltage range	9.6 to 30 VDC
Rated input current	10 mA max. (at 24 VDC)
Must-operate voltage	9.6 VDC max.
Reset voltage	1 VDC min.
Insulation method	Phototriac
Operation indicator	Yellow LED

### ■ MAIN CIRCUIT OF MODELS WITH BUILT-IN HEAT SINKS

Item	G3PB-215B-3-VD	G3PB-215B-2-VD	G3PB-225B-3-VD	G3PB-225B-2-VD	G3PB-235B-3-VD	G3PB-235B-2-VD	G3PB-245B-3-VD	G3PB-245B-2-VD
Rated voltage	100 to 240 VAC							
Operating voltage range	75 to 264 VAC							
Rated carry current	15 A		25 A		35 A		45 A	
Minimum load current	0.2 A				0.5 A			
Inrush current resistance (peak value)	150 A (60 Hz, 1 cycle)		220 A (60 Hz, 1 cycle)		440 A (60 Hz, 1 cycle)			
Permissible $I^2t$ (half 60-Hz wave)	121 A <sup>2</sup> s		260 A <sup>2</sup> s		1,260 A <sup>2</sup> s			
Applicable load (with Class-1 AC resistive load)	5.1 kW max.		8.6 kW		12.1 kW max.		15.5 kW max.	

Item	G3PB-415B-3-VD	G3PB-415B-2-VD	G3PB-425B-3-VD	G3PB-425B-2-VD	G3PB-435B-3-VD	G3PB-435B-2-VD	G3PB-445B-3-VD	G3PB-445B-2-VD
Rated voltage	200 to 400 VAC							
Operating voltage range	180 to 440 VAC							
Rated carry current (See Note.)	15 A		25 A		35 A		45 A	
Minimum load current	0.5 A							
Inrush current resistance (peak value)	220 A (60 Hz, 1 cycle)				440 A (60 Hz, 1 cycle)			
Permissible $I^2t$ (half 60-Hz wave)	260 A <sup>2</sup> s				1,260 A <sup>2</sup> s			
Applicable load (with Class-1 AC resistive load)	10.3 kW max.		17.3 kW max.		24.2 kW max.		31.1 kW max.	

Note: Rated carry current varies depending on the ambient temperature. For details, refer to *Load Current vs. Ambient Temperature* in *Engineering Data*.

## ■ MAIN CIRCUIT OF MODELS WITHOUT BUILT-IN HEAT SINKS

Item	G3PB-215B-3H-VD	G3PB-215B-2H-VD	G3PB-225B-3H-VD	G3PB-225B-2H-VD	G3PB-235B-3H-VD	G3PB-235B-2H-VD	G3PB-245B-3H-VD	G3PB-245B-2H-VD
Rated voltage	100 to 240 VAC							
Operating voltage range	75 to 264 VAC							
Rated carry current (See Note.)	15 A		25 A		35 A		45 A	
Minimum load current	0.2 A				0.5 A			
Inrush current resistance (peak value)	150 A (60 Hz, 1 cycle)		220 A (60 Hz, 1 cycle)		440 A (60 Hz, 1 cycle)			
Permissible $I^2t$ (half 60-Hz wave)	121 A <sup>2</sup> s		260 A <sup>2</sup> s		1,260 A <sup>2</sup> s			
Applicable load (with Class-1 AC resistive load)	The applicable load varies with the heat radiation of the Unit. Refer to <i>Engineering Data</i> for details.							

Item	G3PB-415B-3H-VD	G3PB-415B-2H-VD	G3PB-425B-3H-VD	G3PB-425B-2H-VD	G3PB-435B-3H-VD	G3PB-435B-2H-VD	G3PB-445B-3H-VD	G3PB-445B-2H-VD
Rated voltage	200 to 400 VAC							
Operating voltage range	180 to 440 VAC							
Rated carry current	15 A		25 A		35 A		45 A	
Minimum load current	0.5 A							
Inrush current resistance (peak value)	220 A (60 Hz, 1 cycle)				440 A (60 Hz, 1 cycle)			
Permissible $I^2t$ (half 60-Hz wave)	260 A <sup>2</sup> s				1,260 A <sup>2</sup> s			
Applicable load (with Class-1 AC resistive load)	Refer to <i>Engineering Data</i> for details.							

Note: The rated carry current varies depending on the radiation device or radiation plate to be connected and the ambient temperature. For details, refer to *Load Current vs. Ambient Temperature* in *Engineering Data*.

## ■ CHARACTERISTICS

### Models with Built-in Heat Sinks

Item	G3PB-215B-3-VD	G3PB-215B-2-VD	G3PB-225B-3-VD	G3PB-225B-2-VD	G3PB-235B-3-VD	G3PB-235B-2-VD	G3PB-245B-3-VD	G3PB-245B-2-VD
Operate time	1/2 of load power source cycle + 1 ms max. (DC input)							
Release time	1/2 of load power source cycle + 1 ms max. (DC input)							
Output ON voltage drop	1.6 V (RMS) max.							
Leakage current (See Note.)	10 mA (at 200 VAC)							
Insulation resistance	100 MΩ min. (at 500 VDC)							
Dielectric strength	2,500 VAC, 50/60 Hz for 1 min							
Vibration resistance	Destruction and malfunction: 10 to 55 Hz, 0.75-mm double amplitude							
Shock resistance	Destruction: 294 m/s <sup>2</sup> (30G) Malfunction: 147 m/s <sup>2</sup> (15G)							
Ambient temperature	Operating	-30°C to 80°C (-22°F to 176°F) with no icing or condensation						
	Storage	-30°C to 100°C (-22°F to 212°F) with no icing or condensation						
Ambient humidity	Operating	45% to 85%						
Weight	Approx. 750 g	Approx. 750 g	Approx. 900 g	Approx. 750 g	Approx. 1,150 g	Approx. 900 g	Approx. 1,500 g	Approx. 1,150 g
Approved standards (under application)	UL508, CSA22.2 No. 14, EN60947-4-3 (IEC947-4-3)							
EMC	Emission	AC mains	EN55011 Group 1 Class B					
	Emission	Electromagnetic	EN55011 Group 1 Class B					
	Immunity	ESD	IEC947-4-3 4 kV contact discharge 8 kV air discharge					
	Immunity	Electromagnetic	IEC947-4-3 10 V/m (80 MHz to 1 GHz)					
	Immunity	EFT	IEC947-4-3 2 kV AC power-signal line					
	Immunity	Surge transient	IEC947-4-3 2 kV					
	Immunity	RF disturbance	IEC947-4-3 10 V (0.15 to 80 MHz)					

Note: The leakage current of phase S will be approximately  $\sqrt{3}$  times larger if the 2-element model is applied.

Item	G3PB-415B-3-VD	G3PB-415B-2-VD	G3PB-425B-3-VD	G3PB-425B-2-VD	G3PB-435B-3-VD	G3PB-435B-2-VD	G3PB-445B-3-VD	G3PB-445B-2-VD
Operate time	1/2 of load power source cycle + 1 ms max. (DC input)							
Release time	1/2 of load power source cycle + 1 ms max. (DC input)							
Output ON voltage drop	1.8 V (RMS) max.							
Leakage current (See Note.)	20 mA (at 400 VAC)							
Insulation resistance	100 MΩ min. (at 500 VDC)							
Dielectric strength	2,500 VAC, 50/60 Hz for 1 min							
Vibration resistance	Destruction and malfunction: 10 to 55 Hz, 0.75-mm double amplitude							
Shock resistance	Destruction: 294 m/s <sup>2</sup> (30G) Malfunction: 147 m/s <sup>2</sup> (15G)							
Ambient temperature	Operating	-30°C to 80°C (-22°F to 176°F) with no icing or condensation						
	Storage	-30°C to 100°C (-22°F to 212°F) with no icing or condensation						
Ambient humidity	Operating	45% to 85%						
Weight	Approx. 750 g	Approx. 750 g	Approx. 900 g	Approx. 750 g	Approx. 1,150 g	Approx. 900 g	Approx. 1,500 g	Approx. 1,150 g
Approved standards	UL508, CSA22.2 No. 14, EN60947-4-3 (IEC947-4-3)							

(This table continues on the next page.)

Characteristics Table - continued from previous page

Item	G3PB-415B-3-VD	G3PB-415B-2-VD	G3PB-425B-3-VD	G3PB-425B-2-VD	G3PB-435B-3-VD	G3PB-435B-2-VD	G3PB-445B-3-VD	G3PB-445B-2-VD
EMC	Emission	AC mains	EN55011 Group 1 Class B					
	Emission	Electromagnetic	EN55011 Group 1 Class B					
	Immunity	ESD	IEC947-4-3 4 kV contact discharge 8 kV air discharge					
	Immunity	Electromagnetic	IEC947-4-3 10 V/m (80 MHz to 1 GHz)					
	Immunity	EFT	IEC947-4-3 2 kV AC power-signal line					
	Immunity	Surge transient	IEC947-4-3 2 kV					
Immunity	RF disturbance	IEC947-4-3 10 V (0.15 to 80 MHz)						

Note: The leakage current of phase S will be approximately  $\sqrt{3}$  times larger if the 2-element model is applied.

### Models without Built-in Heat Sinks

Item	G3PB-215B-3H-VD	G3PB-215B-2H-VD	G3PB-225B-3H-VD	G3PB-225B-2H-VD	G3PB-235B-3H-VD	G3PB-235B-2H-VD	G3PB-245B-3H-VD	G3PB-245B-2H-VD
Operate time	1/2 of load power source cycle + 1 ms max. (DC input)							
Release time	1/2 of load power source cycle + 1 ms max. (DC input)							
Output ON voltage drop	1.6 V (RMS) max.							
Leakage current (See Note.)	10 mA (at 200 VAC)							
Insulation resistance	100 M $\Omega$ min. (at 500 VDC)							
Dielectric strength	2,500 VAC, 50/60 Hz for 1 min							
Vibration resistance	Destruction and malfunction: 10 to 55 Hz, 0.75-mm single amplitude							
Shock resistance	Destruction: 294 m/s <sup>2</sup> (30G) Malfunction: 147 m/s <sup>2</sup> (15G)							
Ambient temperature	Operating	-30°C to 80°C (-22°F to 176°F) with no icing or condensation						
	Storage	-30°C to 100°C (-22°F to 212°F) with no icing or condensation						
Ambient humidity	Operating	45% to 85%						
Approved standards (under application)	UL508, CSA22.2 No. 14, EN60947-4-3 (IEC947-4-3)							
Weight (Max.)	300 g max.							
EMC	Emission	AC mains	EN55011 Group 1 Class B					
	Emission	Electromagnetic	EN55011 Group 1 Class B					
	Immunity	ESD	IEC947-4-3 4 kV contact discharge 8 kV air discharge					
	Immunity	Electromagnetic	IEC947-4-3 10 V/m (80 MHz to 1 GHz)					
	Immunity	EFT	IEC947-4-3 2 kV AC power-signal line					
	Immunity	Surge transient	IEC947-4-3 2 kV					
Immunity	RF disturbance	IEC947-4-3 10 V (0.15 to 80 MHz)						

Note: The leakage current of phase S will be approximately  $\sqrt{3}$  times larger if the 2-element model is applied.

### Models without Built-in Heat Sinks

Item	G3PB-415B-3H-VD	G3PB-415B-2H-VD	G3PB-425B-3H-VD	G3PB-425B-2H-VD	G3PB-435B-3H-VD	G3PB-435B-2H-VD	G3PB-445B-3H-VD	G3PB-445B-2H-VD
Operate time	1/2 of load power source cycle + 1 ms max. (DC input)							
Release time	1/2 of load power source cycle + 1 ms max. (DC input)							
Output ON voltage drop	1.8 V (RMS) max.							
Leakage current (See Note.)	20 mA (at 400 VAC)							
Insulation resistance	100 M $\Omega$ min. (at 500 VDC)							
Dielectric strength	2,500 VAC, 50/60 Hz for 1 min							
Vibration resistance	Destruction and malfunction: 10 to 55 Hz, 0.75-mm single amplitude							
Shock resistance	Destruction: 294 m/s <sup>2</sup> (30G) Malfunction: 147 m/s <sup>2</sup> (15G)							
Ambient temperature	Operating	-30°C to 80°C (-22°F to 176°F) with no icing or condensation						
	Storage	-30°C to 100°C (-22°F to 212°F) with no icing or condensation						
Ambient humidity	Operating	45% to 85%						
Approved standards (under application)	UL508, CSA22.2 No. 14, EN60947-4-3 (IEC947-4-3)							
Weight	Approx. 300 g							
EMC	Emission	AC mains	EN55011 Group 1 Class B					
	Emission	Electromagnetic	EN55011 Group 1 Class B					
	Immunity	ESD	IEC947-4-3 4 kV contact discharge 8 kV air discharge					
	Immunity	Electromagnetic	IEC947-4-3 10 V/m (80 MHz to 1 GHz)					
	Immunity	EFT	IEC947-4-3 2 kV AC power-signal line					
	Immunity	Surge transient	IEC947-4-3 2 kV					
	Immunity	RF disturbance	IEC947-4-3 10 V (0.15 to 80 MHz)					

Note: The leakage current of phase S will be approximately  $\sqrt{3}$  times larger if the 2-element model is applied.

### Heat Sinks

Model	Weight
Y92B-P50	Approx. 450 g
Y92B-P100	Approx. 450 g
Y92B-P150	Approx. 600 g
Y92B-P200	Approx. 850 g
Y92B-P250	Approx. 1,200 g

# Specifications for Single Phase Solid State Relays

## ■ RATINGS (AT AN AMBIENT TEMPERATURE OF 25°C)

### Operating Circuit (Common)

Item	Common
Rated operating voltage	12 to 24 VDC
Operating voltage range	9.6 to 30 VDC
Rated input current	7 mA max.
Must-operate voltage	9.6 VDC max.
Reset voltage	1 VDC min.
Insulation method	Phototriac
Operation indicator	Yellow LED

## ■ MAIN CIRCUIT OF MODELS WITH BUILT-IN HEAT SINKS

Item	G3PB-215B-VD	G3PB-225B-VD	G3PB-235B-VD	G3PB-245B-VD
Rated voltage	100 to 240 VAC			
Operating voltage range	75 to 264 VAC			
Rated carry current	15 A	25 A	35 A	45 A
Minimum load current	0.2 A		0.5 A	
Inrush current resistance (peak value)	150 A (60 Hz, 1 cycle)	220 A (60 Hz, 1 cycle)	440 A (60 Hz, 1 cycle)	
Permissible $I^2t$ (half 60-Hz wave)	121 A <sup>2</sup> s	260 A <sup>2</sup> s	1,260 A <sup>2</sup> s	
Applicable load (with Class-1 AC resistive load)	3.6 kW max.	6 kW max.	8.4 kW max.	10.8 kW max.

## ■ CHARACTERISTICS

Item	G3PB-215B-VD	G3PB-225B-VD	G3PB-235B-VD	G3PB-245B-VD
Operate time	1/2 of load power source cycle + 1 ms max. (DC input)			
Release time	1/2 of load power source cycle + 1 ms max. (DC input)			
Output ON voltage drop	1.6 V (RMS) max.			
Leakage current	10 mA max. (at 200 VAC)		20 mA max. (at 200 VAC)	
Insulation resistance	100 MΩ min. (at 500 VDC)			
Dielectric strength	2,500 VAC, 50/60 Hz for 1 min			
Vibration resistance	Destruction and malfunction: 10 to 55 Hz, 0.75-mm double amplitude			
Shock resistance	Destruction: 294 m/s <sup>2</sup> (30G) Malfunction: 147 m/s <sup>2</sup> (15G)			
Ambient temperature	Operating	-30°C to 80°C (-22°F to 176°F) with no icing or condensation		
	Storage	-30°C to 100°C (-22°F to 212°F) with no icing or condensation		
Ambient humidity	Operating	45% to 85%		
Approved standards (under application)	UL508, CSA22.2 No. 14, IEC947-4-3			
Weight	Approx. 240 g	Approx. 240 g	Approx. 400 g	Approx. 400 g



# Engineering Data

## LOAD CURRENT VS. AMBIENT TEMPERATURE (CONTINUOUS INPUT)

### Models with Built-in Heat Sinks

#### Three-phase Models

G3PB-215B-3-VD G3PB-225B-3-VD  
 G3PB-215B-2-VD G3PB-225B-2-VD  
 G3PB-415B-3-VD G3PB-425B-3-VD  
 G3PB-415B-2-VD G3PB-425B-2-VD

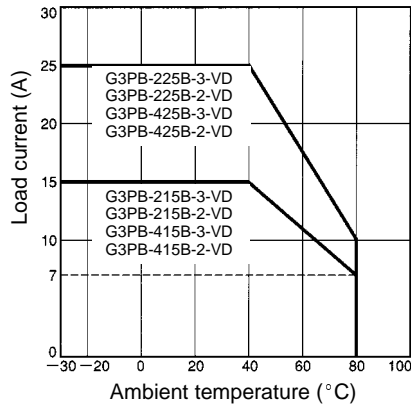

G3PB-235B-3-VD G3PB-245B-3-VD  
 G3PB-235B-2-VD G3PB-245B-2-VD  
 G3PB-435B-3-VD G3PB-445B-3-VD  
 G3PB-435B-2-VD G3PB-445B-2-VD

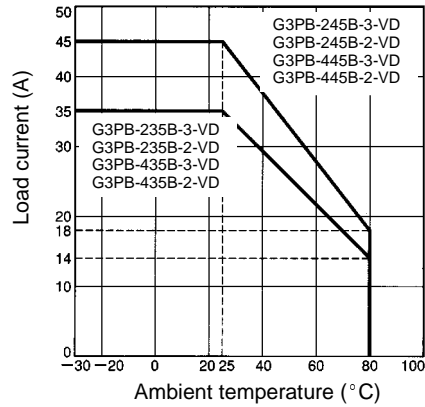

#### Single-phase Models

G3PB-215B-VD  
 G3PB-225B-VD

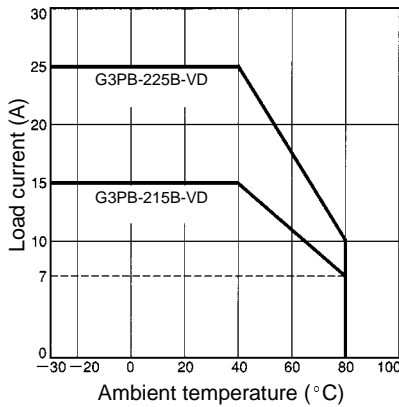

G3PB-235B-VD  
 G3PB-245B-VD

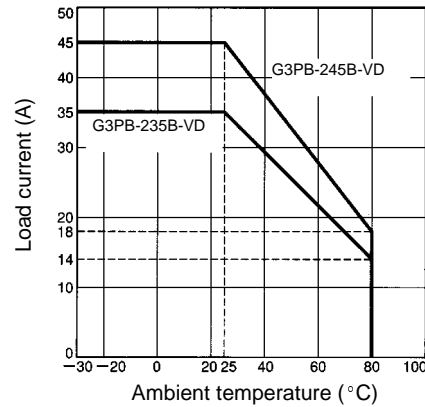

**Models without Built-in Heat Sinks**

G3PB-215B-3H (-2H)-VD  
 G3PB-225B-3H (-2H)-VD  
 G3PB-415B-3H (-2H)-VD  
 G3PB-425B-3H (-2H)-VD

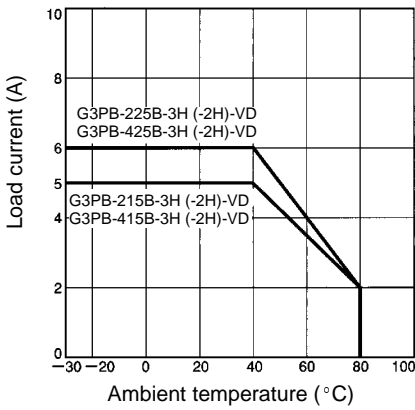

G3PB-235B-3H (-2H)-VD  
 G3PB-245B-3H (-2H)-VD  
 G3PB-435B-3H (-2H)-VD  
 G3PB-445B-3H (-2H)-VD

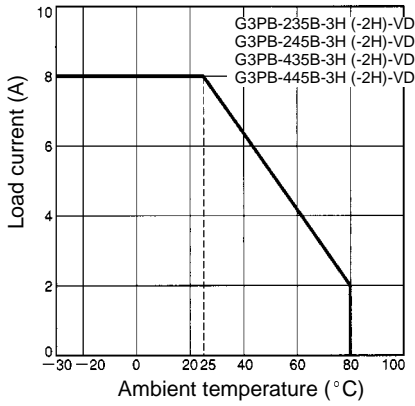

**INRUSH CURRENT RESISTANCE: NON-REPETITIVE (LESS THAN HALF FOR REPETITIVE)**

**Three-phase Models**

G3PB-215B-3 (H)-VD  
 G3PB-215B-2 (H)-VD

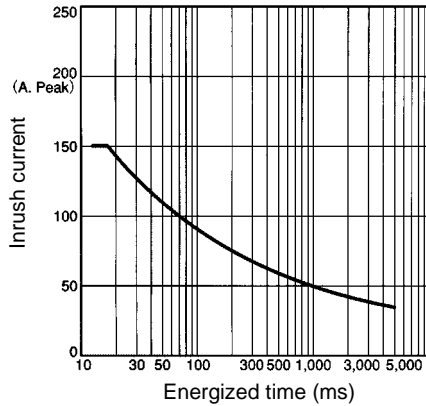

G3PB-225B-3 (H)-VD  
 G3PB-225B-2 (H)-VD  
 G3PB-415B-3 (H)-VD  
 G3PB-415B-2 (H)-VD

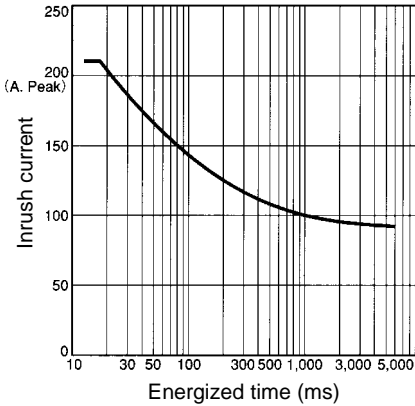

G3PB-235B-3 (H)-VD G3PB-245B-3 (H)-VD  
 G3PB-235B-2 (H)-VD G3PB-245B-2 (H)-VD  
 G3PB-245B-3 (H)-VD G3PB-445B-3 (H)-VD  
 G3PB-245B-2 (H)-VD G3PB-445B-2 (H)-VD

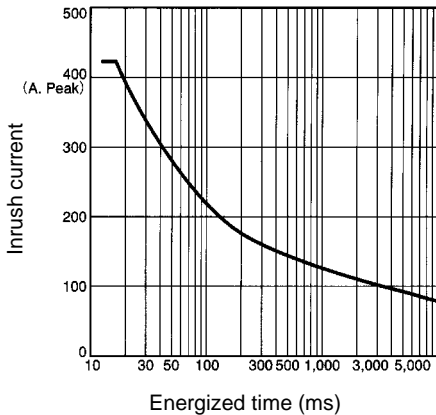

Single-phase Models

G3PB-215B-VD

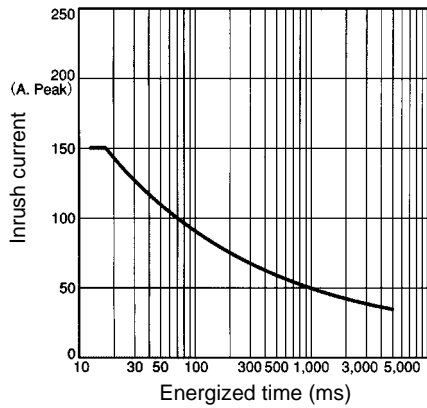

G3PB-225B-VD

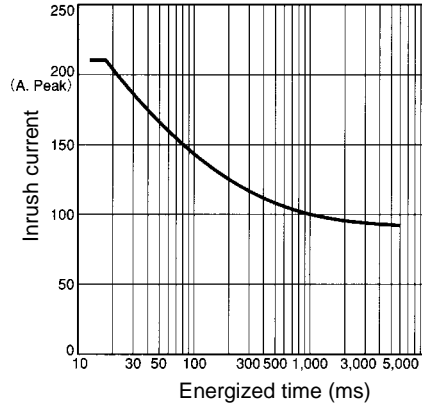

G3PB-235B-VD  
G3PB-245B-VD

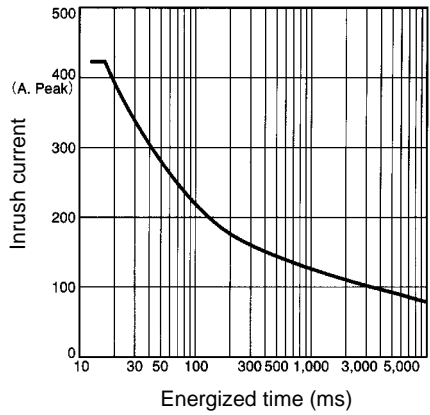

■ HEAT SINK SIZE VS. LOAD CURRENT

Three-phase Models

G3PB-225B-3H-VD

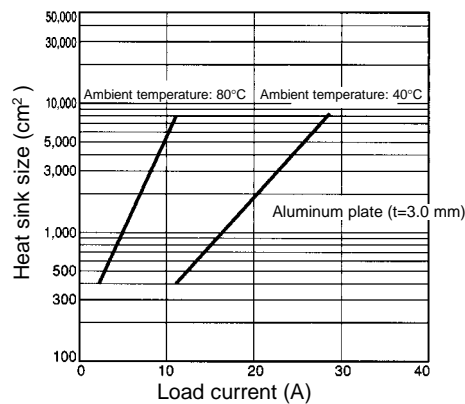

G3PB-425B-3H-VD

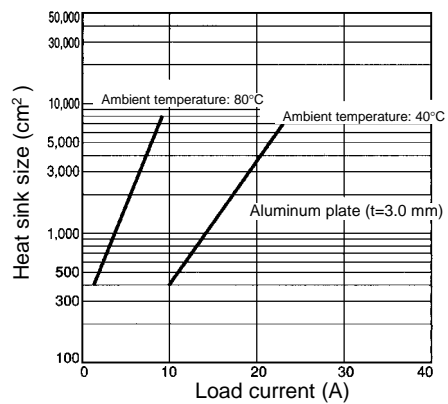

Note: The heat sink size refers to the combined area of the sides of the heat sink that radiate heat. In the case of G3PB-425B-3H-VD, when a current of 18 A is allowed to flow through the SSR at 40°C, the graph shows that the heat sink size is about 2,500 cm<sup>2</sup>. Therefore, if the heat sink is square, one side of the heat sink must be 36 cm (36<sup>2</sup> × 2 = 2,592) or longer.

## ■ INPUT VOLTAGE VS. INPUT CURRENT AND INPUT VOLTAGE VS. INPUT IMPEDANCE

### Three-phase Models

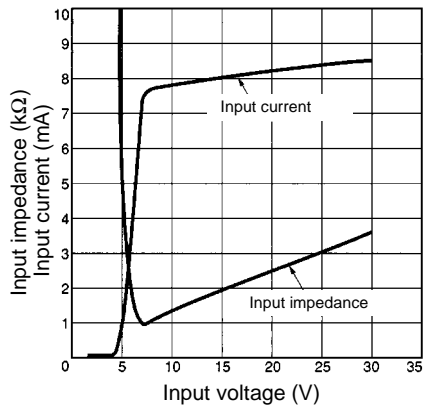

### Single-phase Models

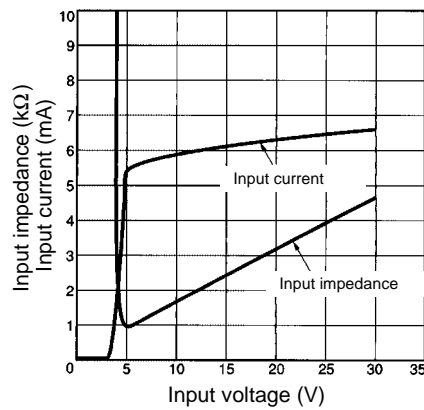

## ■ THERMAL RESISTANCE R<sub>th</sub> (JUNCTION/SSR BACK SURFACE)

### Three-phase Models without Heat Sink

Model	R <sub>th</sub> (°C/W)
G3PB-215B-3H-VD	1.05
G3PB-225B-3H-VD	0.57
G3PB-235B-3H-VD	0.57
G3PB-245B-3H-VD	0.57

# Dimensions

Unit: mm (inch)

## MODELS WITH BUILT-IN HEAT SINKS

### Three-phase Models

G3PB-215B-2-VD  
G3PB-415B-2-VD

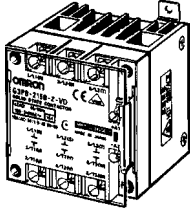

Without Terminal Cover

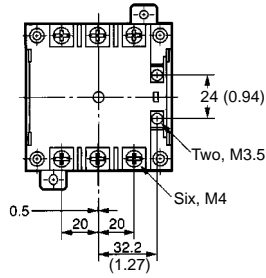

With Terminal Cover

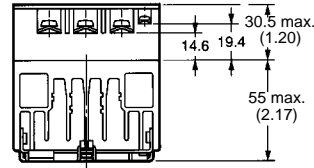
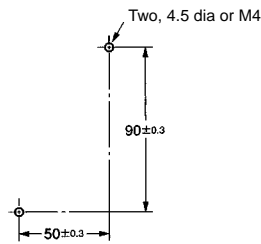
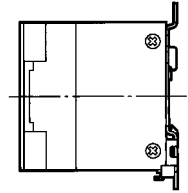
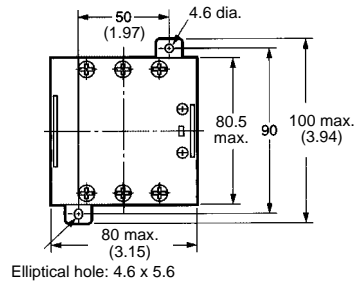

Terminal Arrangement/  
Internal Circuit Diagram

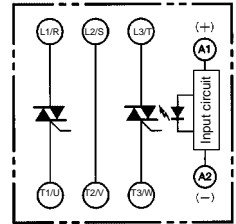

G3PB-215B-3-VD  
G3PB-225B-2-VD  
G3PB-415B-3-VD  
G3PB-425B-2-VD

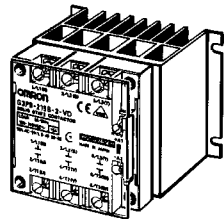

Without Terminal Cover

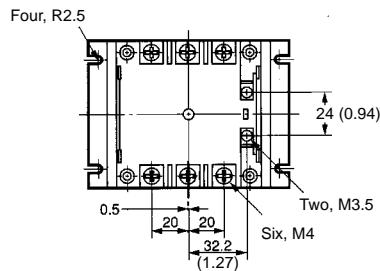

With Terminal Cover

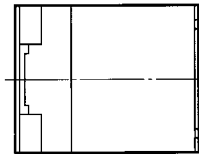
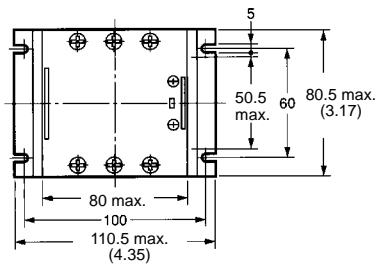

Mounting Holes

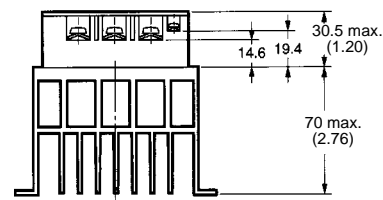
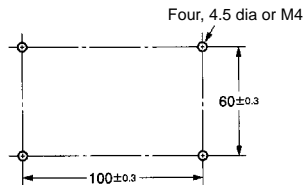

Terminal Arrangement/  
Internal Circuit Diagram

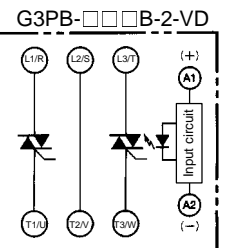
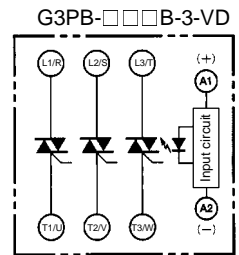

G3PB-225B-3-VD  
 G3PB-235B-2-VD  
 G3PB-425B-3-VD  
 G3PB-435B-2-VD

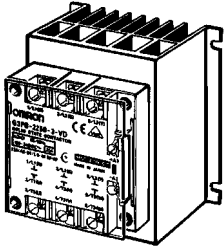

Without Terminal Cover

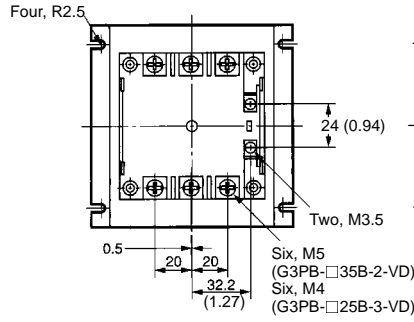

With Terminal Cover

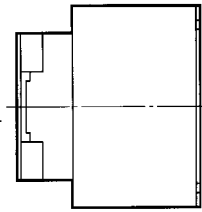
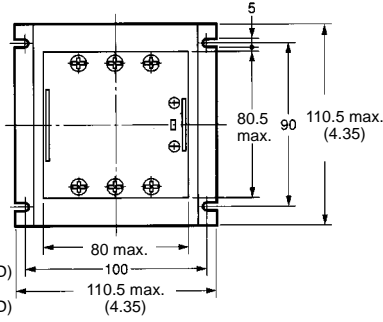

Terminal Arrangement/  
Internal Circuit Diagram

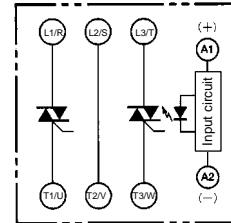
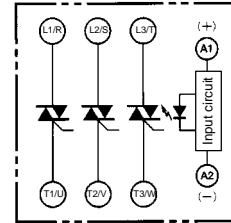

Mounting Holes

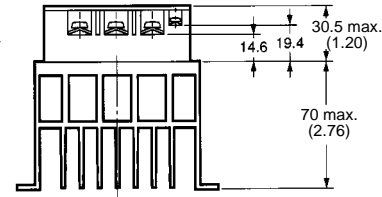
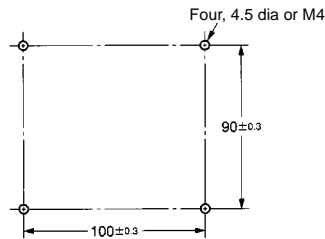

G3PB-235B-3-VD  
 G3PB-245B-2-VD  
 G3PB-435B-3-VD  
 G3PB-445B-3-VD

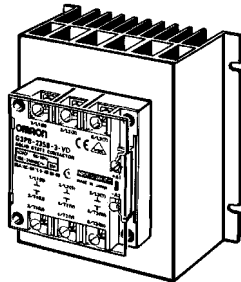

Without Terminal Cover

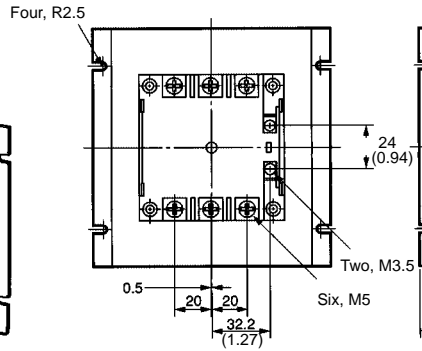

With Terminal Cover

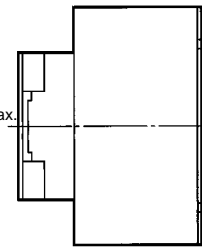
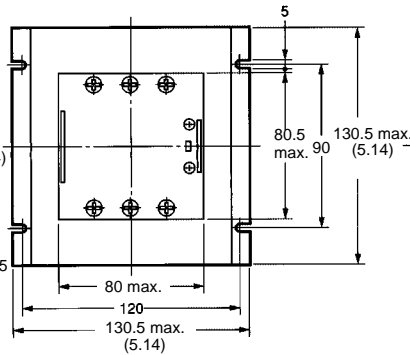

Terminal Arrangement/  
Internal Circuit Diagram

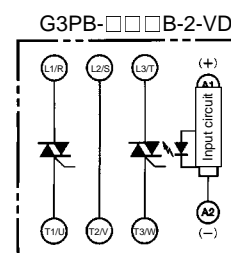
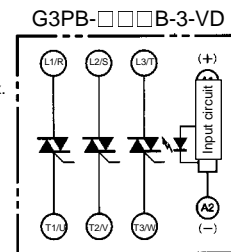

Mounting Holes

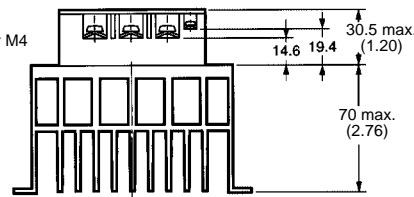
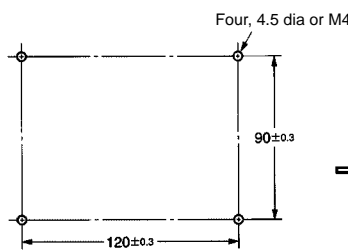

G3PB-245B-3-VD  
G3PB-445B-3-VD

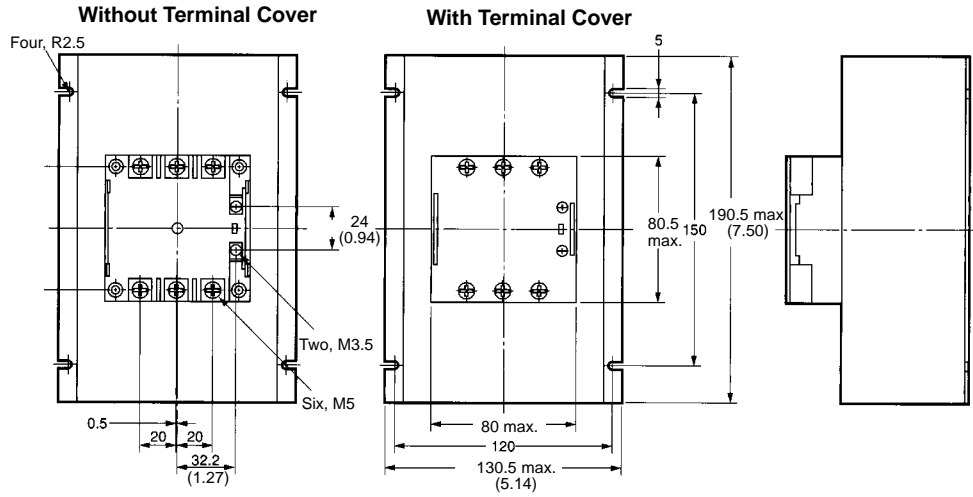
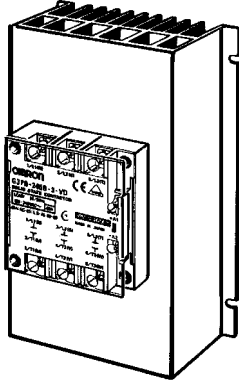

Mounting Holes

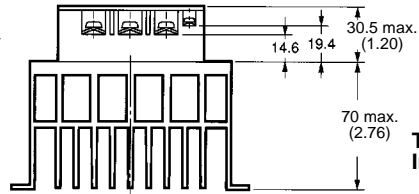
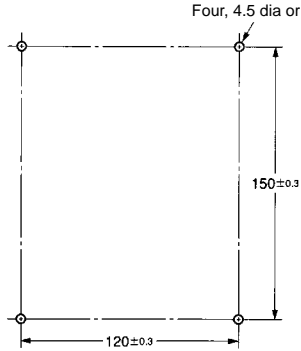

Terminal Arrangement/  
Internal Circuit Diagram

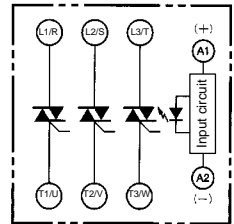

Single-phase Models

G3PB-215B-VD  
G3PB-225B-VD

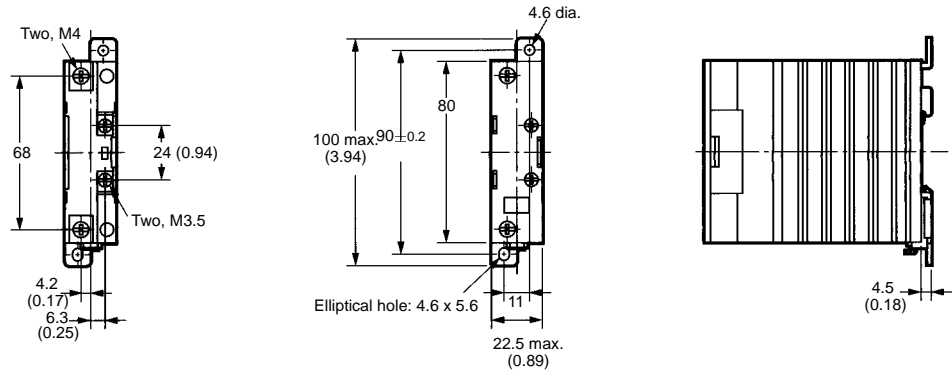
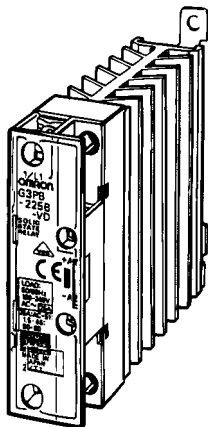

Mounting Holes

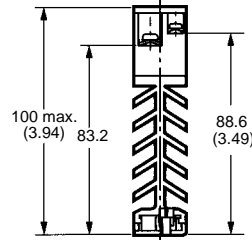
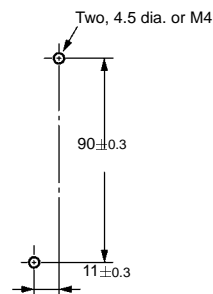

Terminal Arrangement/  
Internal Circuit Diagram

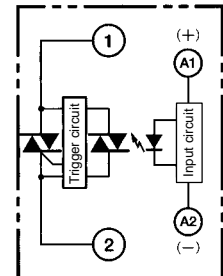

G3PB-235B-VD  
G3PB-245B-VD

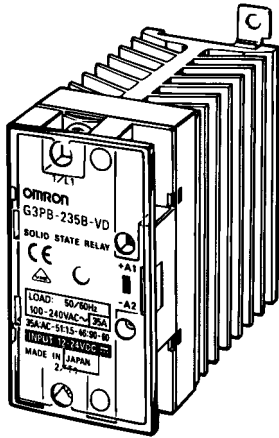

(3.49)

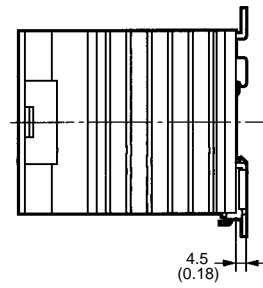
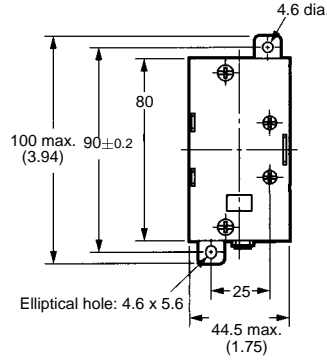
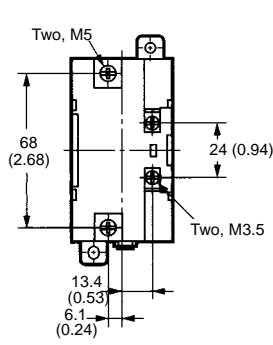

Mounting Holes

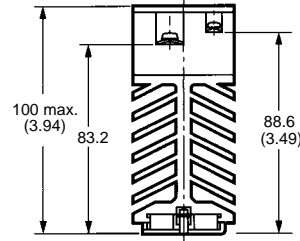
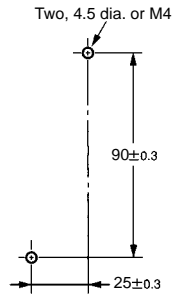

Terminal Arrangement/  
Internal Circuit Diagram

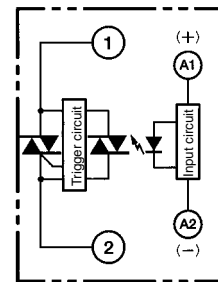

MODELS WITHOUT BUILT-IN HEAT SINKS

- G3PB-215B-3H-VD   G3PB-235B-3H-VD   G3PB-415B-3H-VD   G3PB-435B-3H-VD
- G3PB-215B-2H-VD   G3PB-235B-2H-VD   G3PB-415B-2H-VD   G3PB-435B-2H-VD
- G3PB-225B-3H-VD   G3PB-245B-3H-VD   G3PB-425B-3H-VD   G3PB-445B-3H-VD
- G3PB-225B-2H-VD   G3PB-245B-2H-VD   G3PB-425B-2H-VD   G3PB-445B-2H-VD

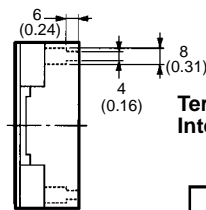
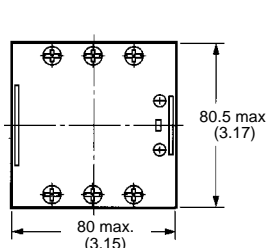
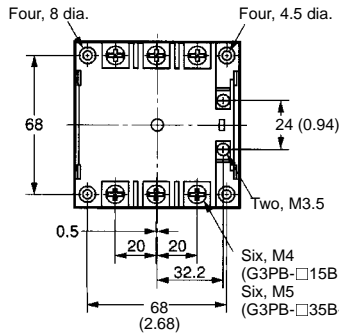
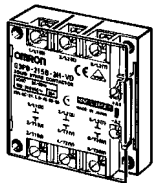

Mounting Holes

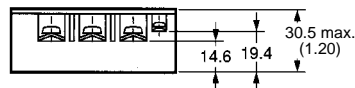
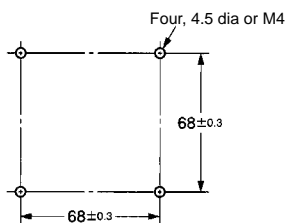

Terminal Arrangement/  
Internal Circuit Diagram

G3PB-□□□B-3H-VD

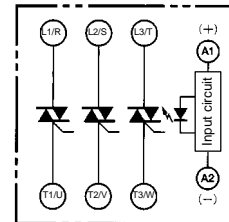

G3PB-□□□B-2H-VD

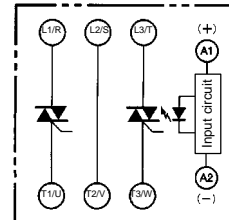



■ HEAT SINKS

Y92B-P50

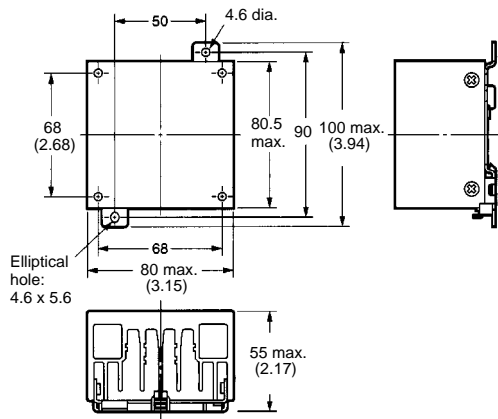

Mounting Holes

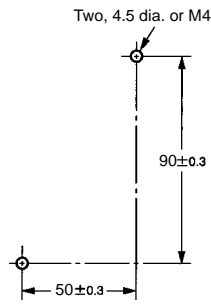

Y92B-P100

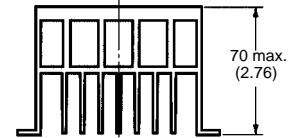
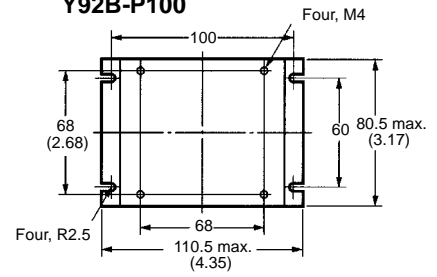

Mounting Holes

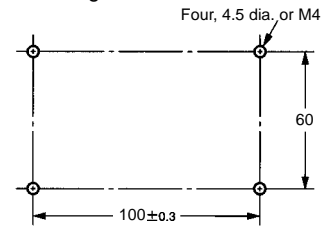

**Y92B-P150**

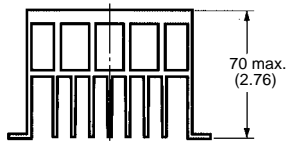
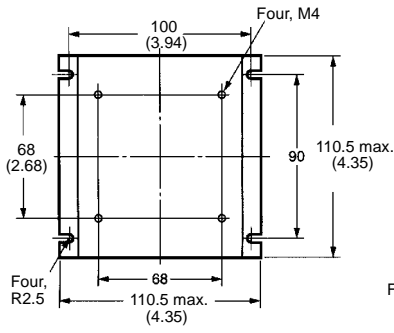

**Mounting Holes**

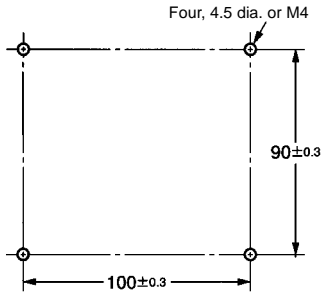

**Y92B-P200**

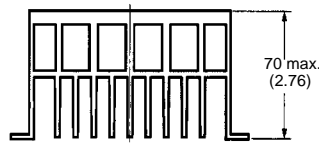
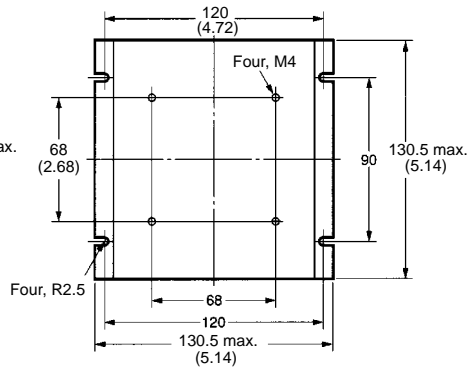

**Mounting Holes**

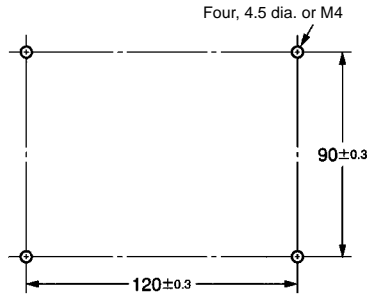

**Y92B-P250**

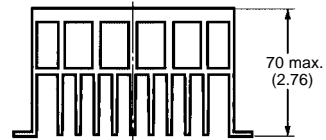
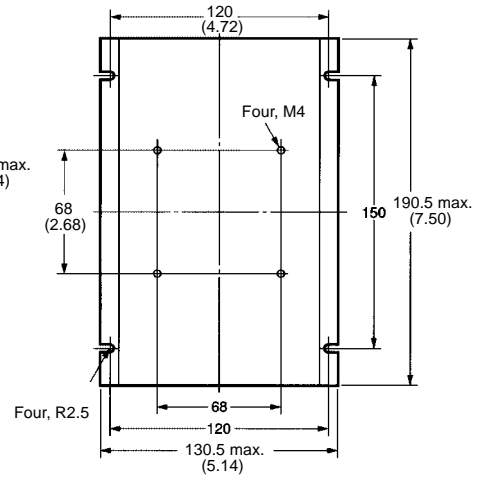

**Mounting Holes**

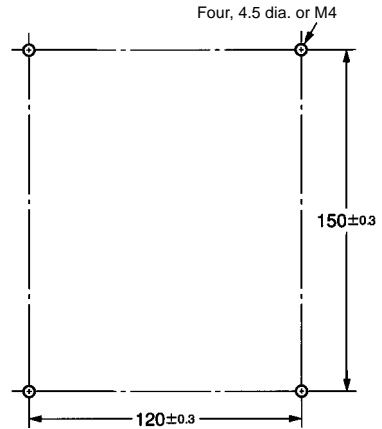

**ACCESSORIES (ORDER SEPARATELY)**

**Mounting Tracks**  
PFP-100N, PFP-50N

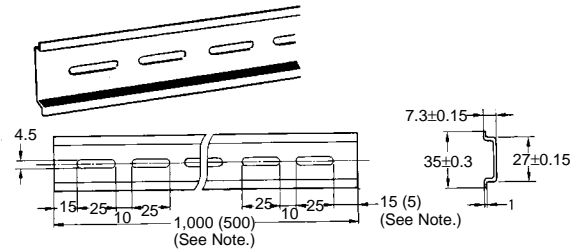

**PFP-100N2**

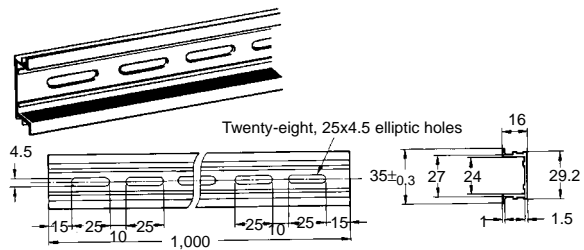

Note: Values in parentheses indicate dimensions for the PFP-50N.

## Precautions



### WARNING

To avoid electric shock, do not touch the terminals (i.e., charged parts) of the G3PB while power is supplied.

If the G3PB is provided with a terminal cover, be sure to attach the terminal cover to the G3PB before operating the G3PB.

The G3PB and radiator are very hot while power is supplied to the G3PB.

Do not touch the G3PB or the radiator while power is supplied to the G3PB or immediately after the G3PB is turned OFF, or a burn may result.

Do not touch the load terminal of the G3PB immediately after the G3PB is turned OFF, otherwise an electric shock may be received due to the residual charge of the built-in snubber circuit.

To avoid electric shock, be sure to turn OFF the power supply to the G3PB before wiring.

Mount the terminal cover to the G3PB after wiring.

Do not touch the terminals of the G3PB while power is supplied, or an electric shock may be received.

The built-in capacitor will be charged as long as power is supplied. To avoid electric shock, do not touch the terminals of the G3PB unless the G3PB is turned OFF and the built-in capacitor discharges all of its residual voltage.



### Caution

Do not apply excessive voltage or current to the input or output circuit of the G3PB, or the G3PB may malfunction or burn.

Do not use the G3PB unless all the output terminal screws are tightened securely, or the terminals may generate excessive heat, and the G3PB may burn.

Be sure to provide enough ventilation to the G3PB and the radiator, or the G3PB may generate excessive heat, and the G3PB may burn or the output element may short-circuit.

Be sure to turn OFF the power supply to the G3PB before wiring, or an electric shock may be received.

Be sure to wire or solder the terminals of the G3PB properly, or the G3PB may generate excessive heat and burn.

If the G3PB is mounted directly to a control panel that is used as a radiator as well, the control panel must be made of aluminum or a steel plate with low thermal resistance.

Do not use any material with high thermal resistance, such as a wooden plate, or the G3PB may catch on fire or burn.

## CORRECT USE

### Before Actual Operation

- To avoid accidents, it is necessary to test the G3PB in operation under a variety of conditions. As for the characteristics of the G3PB, it is necessary to take into consideration the dispersion of the characteristics between G3PB Units.
- The ratings in this datasheet are tested values in a temperature range between 15°C and 30°C, a relative humidity range between 25% and 85%, and an atmospheric pressure range between 88 and 106 kPa. It will be necessary to provide the above conditions, as well as the load conditions, if the user wants to confirm the ratings of actual G3PB Units.

### Mounting Method

Since the Relay is heavy, firmly mount the DIN rail and fix both ends with End Plates for DIN-rail-mounting models.

For direct mounting, firmly mount the Relay on the panel.

### Vertical Mounting

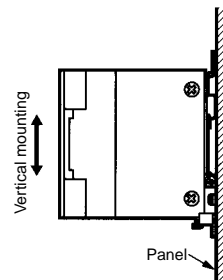

### Horizontal Mounting

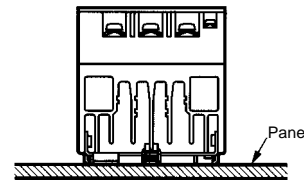

Note: Make sure that the load current is 50% of the rated load current when the G3PB is mounted horizontally.

### Close Mounting

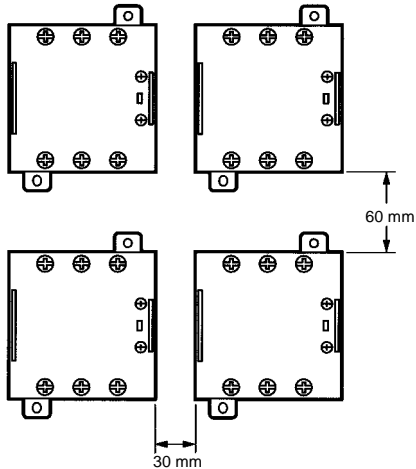

Note: Be sure to provide a minimum space of 30 mm horizontally and 60 mm vertically between adjacent Units.

### Wiring

- When using crimp terminals, refer to the terminal clearances shown below.

#### Output terminal section

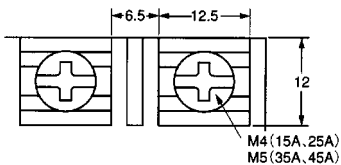

#### Input terminal section

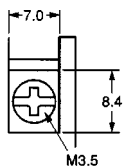

- Be sure that all lead wires are thick enough according to the current.
- Output terminals T1, T2, and T3 are charged regardless of whether the Unit is a 2- or 3-element model that is turned on or off. Do not touch these terminals, otherwise an electric shock may be received.
- To isolate the Unit from the power supply, install an appropriate circuit breaker between the power supply and Unit.
- Be sure to turn off the power supply before wiring the Unit.
- Terminal L2 and terminal T2 of the 2-element model are internally short-circuited to each other. Therefore, connect terminal L2 to the ground terminal of the power supply. If terminal L2 is connected to a terminal other than the ground terminal, cover all the charged terminals, such as heater terminals, for the prevention of electric shock accidents and ground faults.

### Tightening Torque

Refer to the following and be sure to tighten each screw of the Unit to the specified torque in order to prevent the Unit from malfunctioning.

Item	Screw terminal diameter	Tightening torque
Input terminal	M3.5	0.8 N • m (7.84 kgf • cm)
Output terminal	M4	1.2 N • m (11.8 kgf • cm)
	M5	2.0 N • m (19.6 kgf • cm)

### Mounting Models without Built-in Heat Sink

- Before attaching an external radiator or Heat Sink to the Unit, be sure to apply silicone grease for heat radiation, such as Toshiba's YG6260 or Sinetsu Silicone's G746, to the surface where the radiator or Heat Sink is attached.
- Be sure to apply the following torque to secure the Unit and external radiator or Heat Sink for proper heat radiation.
- Tightening torque: 2.0 N • m (19.6 kgf • cm)

### OPERATING CONDITIONS

- Do not apply current exceeding the rated current, or the temperature of the Unit may rise excessively.
- Be sure to prevent ambient temperature rising due to the heat radiation of the Unit. In the case of enclosed mounting, install a fan so that the interior of the panel can be fully ventilated.

### OPERATING AND STORAGE ENVIRONMENTS

Do not use or store the Unit in the following places, to avoid malfunction or deterioration of operating characteristics.

- Locations subject to direct sunlight.
- Locations subject to ambient operating temperatures outside the range of  $-30^{\circ}\text{C}$  to  $80^{\circ}\text{C}$ .
- Locations subject to ambient operating humidity outside the range of 45% to 85%.
- Locations subject to condensation as the result of severe changes in temperature.
- Locations subject to ambient storage temperatures outside the range of  $-30^{\circ}\text{C}$  to  $100^{\circ}\text{C}$ .
- Locations subject to corrosive or flammable gases.
- Locations subject to dust (especially iron dust) or salts.
- Locations subject to shock or vibration.
- Locations subject to exposure to water, oil, or chemicals.

---

**OMRON**<sup>®</sup>  
**OMRON ELECTRONICS, INC.**  
One East Commerce Drive  
Schaumburg, IL 60173  
**1-800-55-OMRON**

**OMRON CANADA, INC.**  
885 Milner Avenue  
Scarborough, Ontario M1B 5V8  
**416-286-6465**