

COS/MOS INTEGRATED CIRCUITS



41C 08817 DT-51-11

PRELIMINARY DATA

ANALOG MULTIPLEXERS-DEMULPLEXERS:

- 4051B - SINGLE 8-CHANNEL
- 4052B - DIFFERENTIAL 4-CHANNEL
- 4053B - TRIPLE 2-CHANNEL

- QUIESCENT CURRENT SPECIFIED TO 20V FOR HCC DEVICE
- LOW "ON" RESISTANCE: 125Ω (TYP.) OVER 15V p.p. SIGNAL-INPUT RANGE for $V_{DD}-V_{EE}=15V$
- HIGH "OFF" RESISTANCE: CHANNEL LEAKAGE ± 100 pA (TYP.) $V_{DD}-V_{EE}=18V$
- BINARY ADDRESS DECODING ON CHIP
- VERY LOW QUIESCENT POWER DISSIPATION UNDER ALL DIGITAL CONTROL INPUT and SUPPLY CONDITIONS: 0.2 μW (TYP.), $V_{DD}-V_{SS}=V_{DD}-V_{EE}=10V$
- MATCHED SWITCH CHARACTERISTICS: $R_{ON}=5\Omega$ (TYP.) for $V_{DD}-V_{EE}=15V$
- WIDE RANGE OF DIGITAL AND ANALOG SIGNAL LEVELS: DIGITAL 3 TO 20V, ANALOG TO 20V p.p.
- 5V, 10V, AND 15V PARAMETRIC RATINGS
- INPUT CURRENT OF 100 mA AT 18V AND 25°C FOR HCC DEVICE
- 100% TESTED FOR QUIESCENT CURRENT
- MEETS ALL REQUIREMENTS OF JEDEC TENTATIVE STANDARD No. 13A, "STANDARD SPECIFICATIONS FOR DESCRIPTION OF "B" SERIES CMOS DEVICES"

The HCC 4051B, 4052B and 4053B (extended temperature range) and HCF 4051B, 4052B and 4053B (intermediate temperature range) are monolithic integrated circuits, available in 16-lead dual in-line plastic or ceramic package, ceramic flat package and plastic micropackage. HCC/HCF 4051B, HCC/HCF 4052B, and HCC/HCF 4053B analog multiplexers/demultiplexers are digitally controlled analog switches having low ON impedance and very low OFF leakage current. These multiplexer circuits dissipate extremely low quiescent power over the full $V_{DD}-V_{SS}$ and $V_{DD}-V_{EE}$ supply-voltage ranges, independent of the logic state of the control signals. When a-logic "1" is present at the inhibit input terminal all channel are off. The HCC/HCF 4051B is a single 8-channel multiplexer having three binary control inputs, A, B, and C, and an inhibit input. The three binary signals select 1 of 8 channels to be turned on, and connect one of the 8 inputs to the output. The HCC/HCF 4052B is a differential 4-channel multiplexer having two binary control inputs, A and B, and an inhibit input. The two binary input signals select 1 of 4 pairs of channels to be turned on and connect the analog inputs to the outputs. The HCC/HCF 4053B is a triple 2-channel multiplexer having three separate digital control inputs, A, B, and C, and an inhibit input. Each control input selects one of a pair of channels which are connected in a single-pole double-throw configuration.

ABSOLUTE MAXIMUM RATINGS

V_{DD}^*	Supply voltage: HCC types HCF types	-0.5 to 20 -0.5 to 18	V V
V_I	Input voltage	-0.5 to $V_{DD} + 0.5$	V
I_I	DC input current (any one input)	± 10	mA
P_{tot}	Total power dissipation (per package) Dissipation per output transistor for T_{op} = full package-temperature range	200 100	mW mW
T_{op}	Operating temperature: HCC types HCF types	-55 to 125 -40 to 85	°C °C
T_{stg}	Storage temperature	-65 to 150	°C

* All voltage values are referred to V_{SS} pin voltage

ORDERING NUMBERS:

- HCC 4XXX BD for dual in-line ceramic package
- HCC 4XXX BF for dual in-line ceramic package, frit seal
- HCC 4XXX BE for ceramic flat package
- HCF 4XXX BE for dual in-line plastic package
- HCF 4XXX BF for dual in-line ceramic package, frit seal
- HCF 4XXX BM for plastic micropackage

HCC/DCF 4051B
HCC/DCF 4052B
HCC/DCF 4053B

41C 08818 D T-51-11

MECHANICAL DATA (dimensions in mm)

Dual in-line ceramic package for HCC 4XXX BD

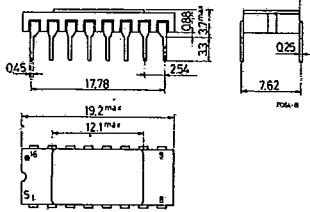

Dual in-line ceramic package for HCC/DCF 4XXX BF

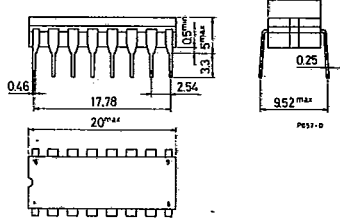

Dual in-line plastic package for HCF 4XXX BE

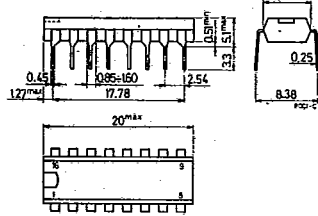

Ceramic flat package for HCC 4XXX BK

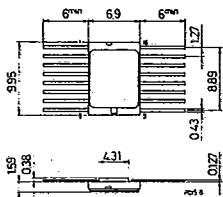

Plastic micropackage for HCF 4XXX BM

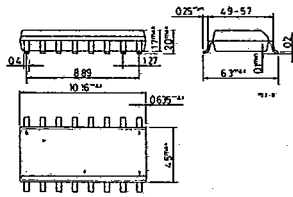

CONNECTION DIAGRAMS

for 4051B

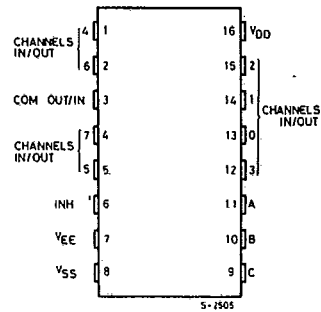

for 4052B

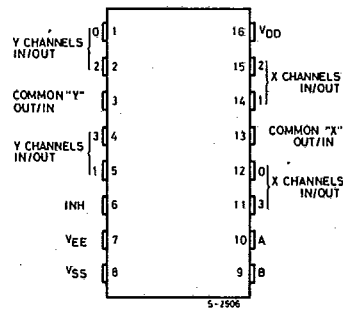

for 4053B

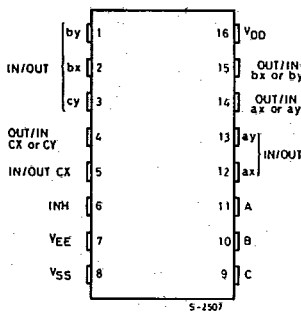

RECOMMENDED OPERATING CONDITIONS

V_{DD}	Supply voltage: HCC types HCF types	3 to 18 V 3 to 15 V
V_I	Input voltage	0 to V_{DD} V
T_{op}	Operating temperature: HCC types HCF types	-55 to 125 °C -40 to 85 °C



HCC/HCF 4051B
HCC/HCF 4052B
HCC/HCF 4053B

41C 08819 D T-51-11

FUNCTIONAL DIAGRAMS AND TRUTH TABLES

For 4051B

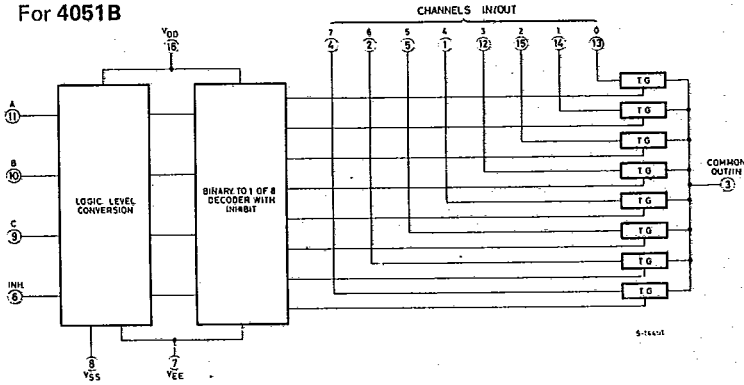

INPUT STATES				*ON* CHANNEL(S)
INHIBIT	C	B	A	
0	0	0	0	0
0	0	0	1	1
0	0	1	0	2
0	0	1	1	3
0	1	0	0	4
0	1	0	1	5
0	1	1	0	6
0	1	1	1	7
1	X	X	X	NONE

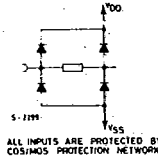

For 4052B

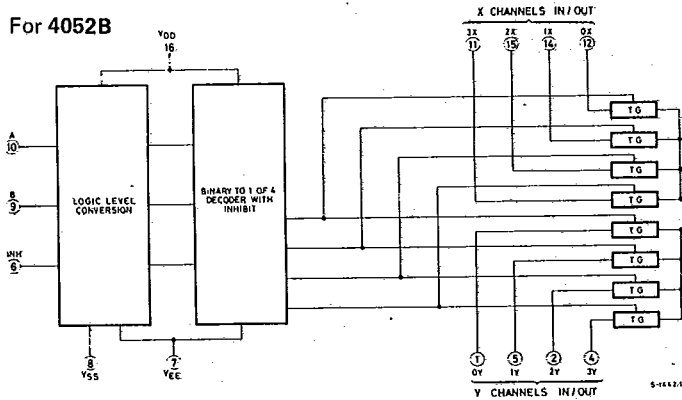

INHIBIT	B	A	
0	0	0	0x, 0y
0	0	1	1x, 1y
0	1	0	2x, 2y
0	1	1	3x, 3y
1	X	X	NONE

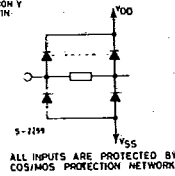

For 4053B

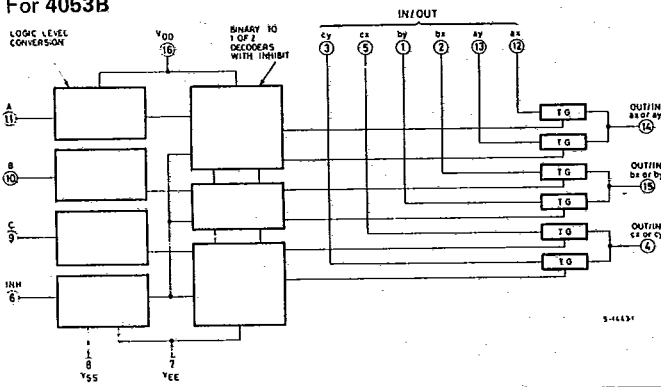

INHIBIT	A or B or C	
0	0	ax or bx or cx
0	1	ay or by or cy
1	X	NONE

X = Don't care.

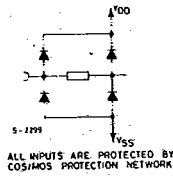



41C 08820 D T-51-11

STATIC ELECTRICAL CHARACTERISTICS (over recommended operating conditions)

Parameter		Test conditions				Values						Unit	
		V _{IS} (V)	V _{EE} (V)	V _{SS} (V)	V _{DD} (V)	T _{Low} (*)		25°C			T _{High} (*)		
						Min.	Max.	Min.	Typ.	Max.	Min.		Max.
I _L	Quiescent device current	HCC types				5		0.04	5	150	μA		
						10		0.04	10	300			
						15		0.04	20	600			
		HCF types				20		0.08	100	3000			
						5		0.04	20	150			
						10		0.04	40	300			
		15		0.04	80	600							
SWITCH													
ON	Resistance	HCC types	0 < V _I < V _{DD}	0	0	5		880	470	1050	1200	Ω	
						10		310	180	400	580		
						15		220	125	280	400		
		HCF types				5		880	470	1050	1200		
						10		330	180	400	520		
						15		230	125	280	360		
ΔON	Resistance ΔR _{ON} (Between any 2 channels)		0	0	5		10				Ω		
					10		10						
					15		5						
OFF(*)	Channel Leakage Current	HCC types	0	0	18	100		±0.1	100	1000	nA		
						100		±0.1	100	1000			
		HCF types				300		±0.1	300	1000	nA		
						300		±0.1	300	1000			
C	Capacitance			-5	-5	5	5				pF		
							30						
							18						
							9						
		0.2											
CONTROL (Address or Inhibit)													
V _{IL}	Input low voltage		=V _{DD} thru 1KΩ	V _{EE} =V _{SS} R _L =1KΩ to V _{SS} I _{IS} <2 μA (on all OFF channels)	5		1.5		1.5	1.5	V		
					10		3		3	3			
					15		4		4	4			
V _{IH}	Input high voltage				5		3.5	3.5	3.5	V			
					10		7	7	7				
					15		11	11	11				
I _{IH} , I _{IL}	Input leakage current	HCC types	V _I = 0/18V		18		±0.1	±10 ⁻³	±0.1	±1	μA		
					15		±0.3	±10 ⁻³	±0.3	±1			
C _I	Input capacitance	HCF types	V _I = 0/15V		15		±0.3	±10 ⁻³	±0.3	±1	pF		
					Any address or inhibit input		5		7.5				

(●) Determined by minimum feasible leakage measurement for automatic testing.

(*) T_{Low} = - 65°C for HCC device; - 40°C for HCF device.

T_{High} = +125°C for HCC device; +85°C for HCF device.



41C 08821 DT-51-11

DYNAMIC ELECTRICAL CHARACTERISTICS ($T_{amb} = 25^{\circ}C$, $C_L = 50$ pF all input square wave rise and fall time = 20 ns)

Parameter	Test conditions						Values		Unit			
	V_{EE} (V)	R_L (k Ω)	f_i (KHz)	V_{IS} (V)	V_{SS} (V)	V_{DD} (V)	Typ.	Max.				
SWITCH												
t_{pd} Propagation delay time (Signal Input to output)	200					5	30	30	ns			
						10	15	60				
						15	11	20				
Frequency Response Channel "ON" (Sine Wave Input) at 20 Log $\frac{V_o}{V_i} = -3dB$	$=V_{SS}$	1		5(*)		10	V_o at Common OUT/IN	4053B	30	MHz		
								4052B	25			
								4051B	20			
							V_o at Any Channel	60				
Feedthrough (All channels OFF) at 20 Log $\frac{V_o}{V_i} = -40$ dB	$=V_{SS}$	1		5(*)		10	V_o at Common OUT/IN	4053	8	MHz		
								4052	10			
								4051	12			
							V_o at Any channel	8				
Frequency Signal Crosstalk at 20 Log $\frac{V_o}{V_i} = -40$ dB	$=V_{SS}$	1		5(*)		10	Between Any 2 channels		3	MHz		
							Between sections 4052B only	Measured on common	6			
								Measured on Any channel	10			
							Between Any 2 sections 4053B only	In Pin 2 Out Pin 14	2.5		MHz	
In Pin 15 Out Pin 14	6											
Sine wave Distortion $f_{IS} = 1$ KHz sine wave	$=V_{SS}$	10	1	2(*)		5			0.3	%		
							10	1	3(*)		10	0.2
							10	1	5(*)		15	0.12
CONTROL (Address or Inhibit)												
Propagation delay time: Address - to Signal OUT Channels ON or OFF	0						0	5	360	720	ns	
	0						10	160	320			
	0						15	120	240			
	-5						5	225	450			
Propagation delay time: Inhibit to signal OUT (channel turning ON)	0	10					0	5	360	720	ns	
	0						10	160	320			
	0						15	120	240			
	-10						5	200	400			
Propagation delay time: Inhibit to signal OUT (channel turning OFF)	0	0.3						5	200	450	ns	
	0						10	90	210			
	0						15	70	160			
	-10						5	130	300			
Address or Inhibit to Signal Crosstalk	0	10*			0	10	$V_C = V_{DD} - V_{SS}$ (Square Wave)	65		mV peak		

(*) Peak to peak voltage symmetrical about $\frac{V_{DD} - V_{EE}}{2}$
 (*) Both ends of channel.

HCC/HCF 4051B
 HCC/HCF 4052B
 HCC/HCF 4053B

41C 08822 DT-51-11

Typical channel ON resistance vs. input signal voltage (all types)

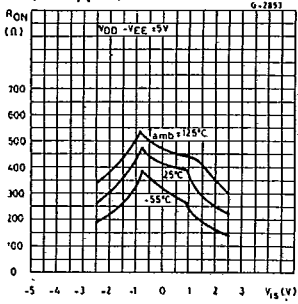

Typical channel ON resistance vs. input signal voltage (all types)

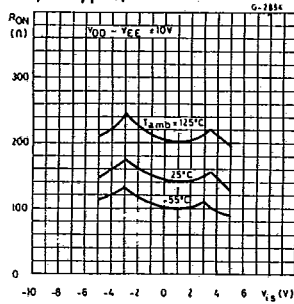

Typical channel ON resistance vs. input signal voltage (all types)

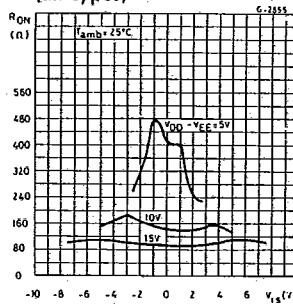

Typical channel ON resistance vs. input signal voltage (all types)

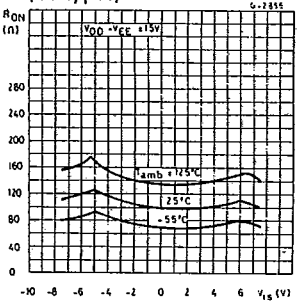

Typical dynamic power dissipation/package vs. switching frequency and test circuit (4051B)

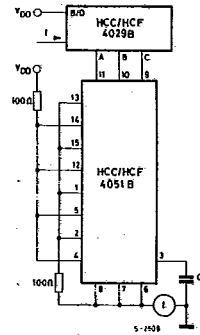
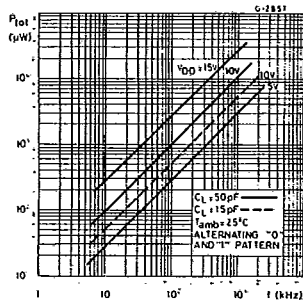

Typical ON characteristics for 1 of 8 channels (4051B)

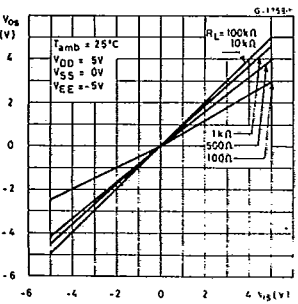

Typical dynamic power dissipation/package vs. switching frequency and test circuit (4052B)

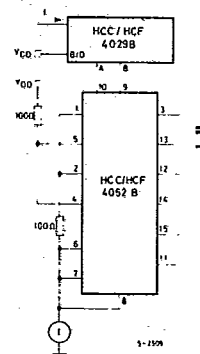
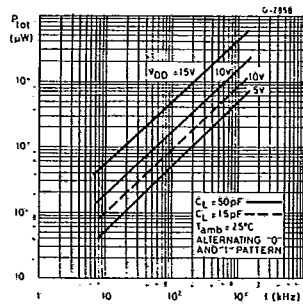



41C 08823 D T-51-11

Typical dynamic power dissipation/package vs. switching frequency and test circuit (4053B)

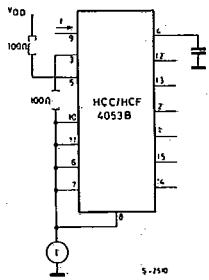
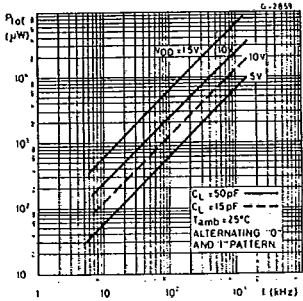

WAVEFORMS

Channel being turned ON (RL = 10 KΩ)

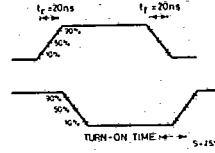

Channel being turned OFF (RL = 300Ω)

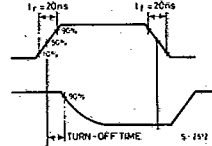

TYPICAL BIAS VOLTAGES

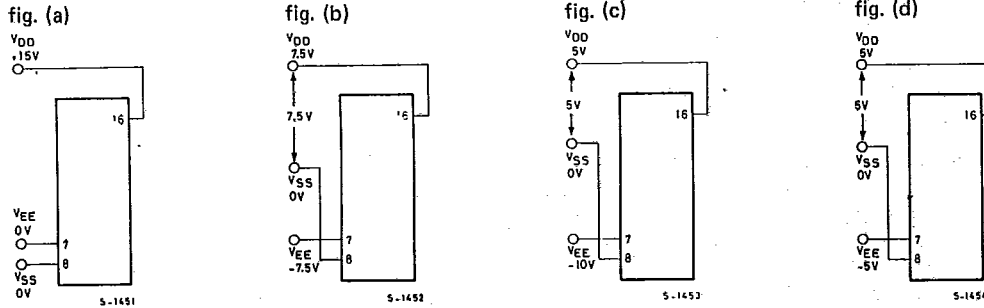

The ADDRESS (digital-control inputs) and INHIBIT logic levels are: "0" = VSS and "1" = VDD. The analog signal (through the TG) may swing from VEE to VDD.

TEST CIRCUITS

OFF channel leakage current-any channel OFF

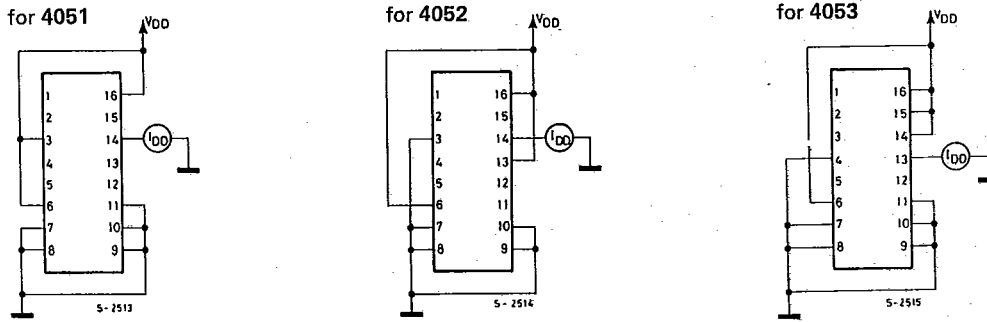

HCC/HCF 4051 B
 HCC/HCF 4052 B
 HCC/HCF 4053 B

41C 08824 D T-51-11

TEST CIRCUITS (continued)

OFF channel leakage current - all channel OFF

for 4051

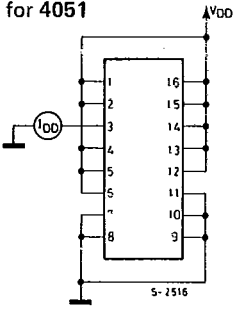

for 4052

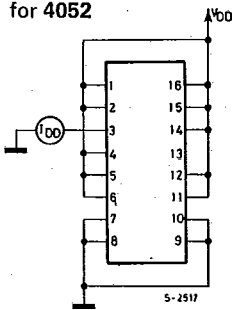

for 4053

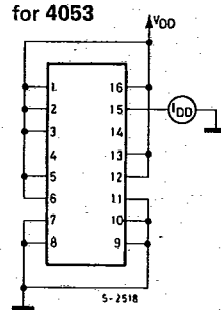

Propagation delay - address input to signal output

for 4051

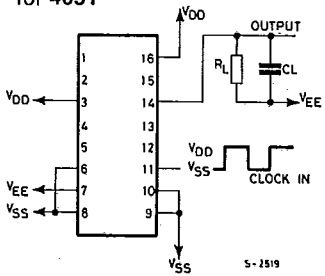

for 4052

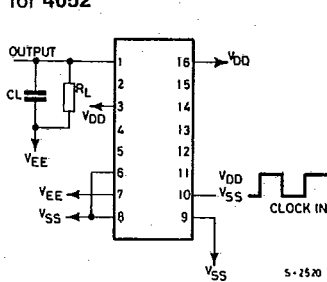

for 4053

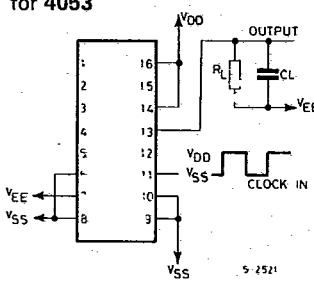

Propagation delay-inhibit input to signal output

for 4051

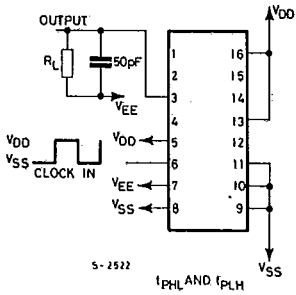

for 4052

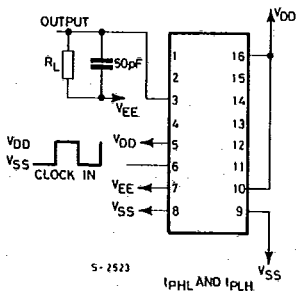

for 4053

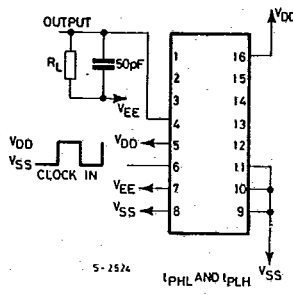

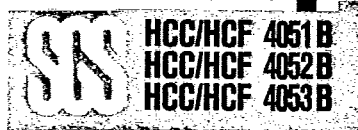

41C 08825 0 T-51-11

TEST CIRCUITS (continued)

Input voltage

for 4051

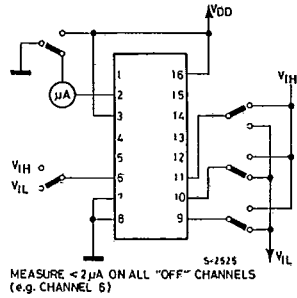

for 4052

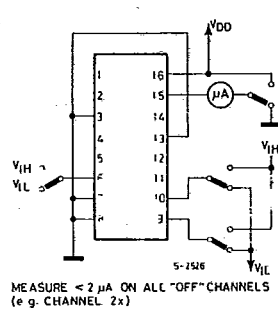

for 4053

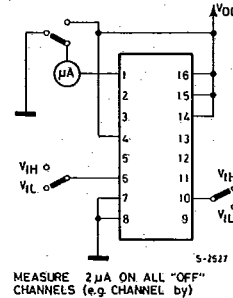

Quiescent device current

for 4051
4053

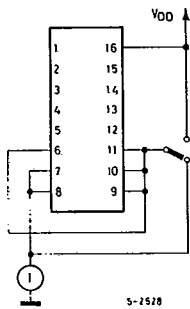

for 4052

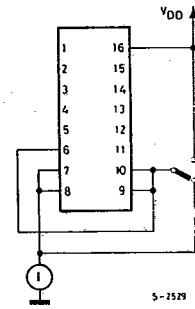

Channel ON resistance measurement circuit

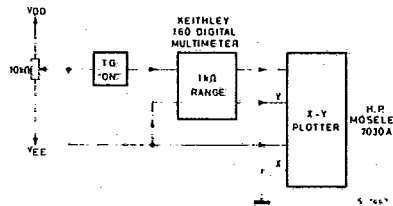

Input current

for 4051
4053

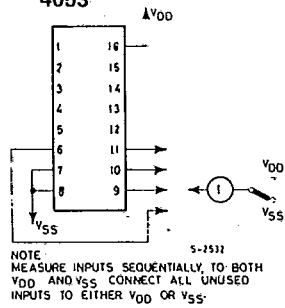

for 4052

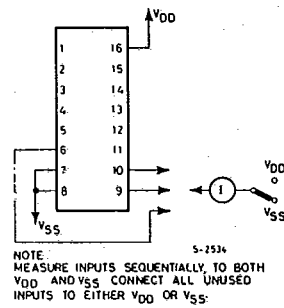

Feedthrough (all types)

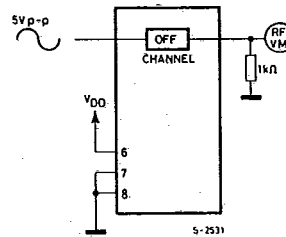

HCC/HCF 4051 B
 HCC/HCF 4052 B
 HCC/HCF 4053 B

41C 08826 0 T-51-11

TEST CIRCUITS (continued)

Crosstalk between any two channels (all types)

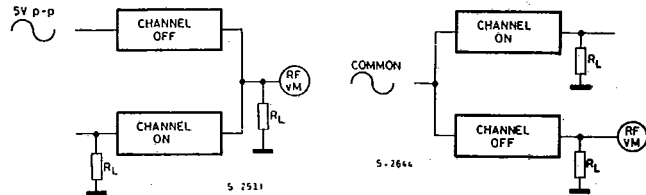

Crosstalk between duals or triplets (4052-4053)

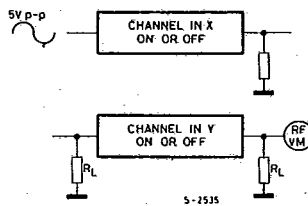

TYPICAL APPLICATIONS

Typical time-division application of the 4052B

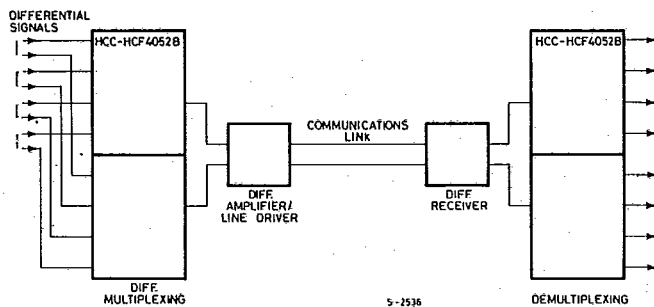

SPECIAL CONSIDERATIONS

Control of analog signals up to 20V peak-to-peak can be achieved by digital signal amplitudes of 4.5 to 20 V (if $V_{DD}-V_{SS}=3V$, a $V_{DD}-V_{EE}$ of up to 13V can be controlled; for $V_{DD}-V_{EE}$ level differences above 13V, a $V_{DD}-V_{SS}$ of at least 4.5V is required). For example, if $V_{DD}=+5V$, $V_{SS}=0$, and $V_{EE}=-13.5V$, analog signals from -13.5V to +4.5V can be controlled by digital inputs of 0 to 4.5V. In certain applications, the external load-resistor current may include both V_{DD} and signal-line components. To avoid drawing V_{DD} current when switch current flows into the transmission gate inputs, the voltage drop across the bidirectional switch must not exceed 0.8 volt (calculated from R_{ON} values shown in ELECTRICAL CHARACTERISTICS CHART). No V_{DD} current will flow through R_L if the switch current flows into lead 3 on the HCC/HCF 4051; leads 3 and 13 on the HCC/HCF 4052; leads 4, 14, and 15 on the HCC/HCF 4053.

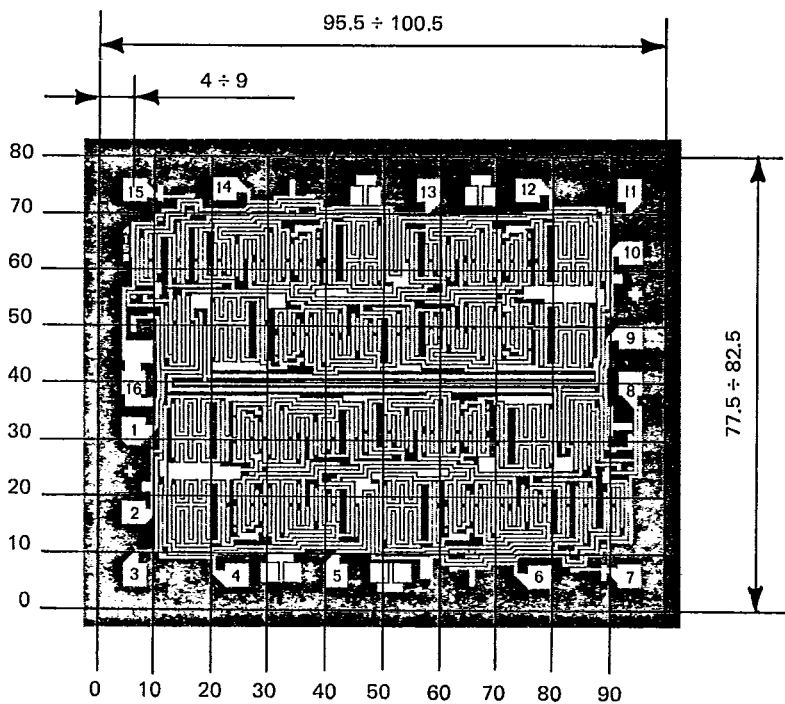

4015B

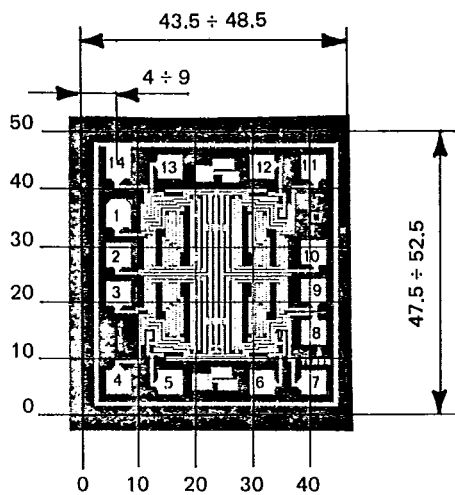

4016B