

PLEASE CHECK WWW.MOLEX.COM FOR LATEST PART INFORMATION

Part Number: [0003092062](#)
Status: **Active**
Overview: [standard_093](#)
Description: 2.36mm (.093") Diameter Standard .093 Pin and Socket Plug Housing, 6 Circuits, Dual Row

Documents:

3D Model	Product Specification PS-02-09 (PDF)
Packaging Specification (PDF)	Product Specification PS-43660-9999 (PDF)
Drawing (PDF)	RoHS Certificate of Compliance (PDF)

Agency Certification

CSA	LR19980
UL	E29179

General

Product Family	Crimp Housings
Series	1261
Comments	14.0A max. can be achieved when housing is used with 42477 or 42478 terminals
Overview	standard_093
Product Name	Standard .093"

Physical

Circuits (maximum)	6
Color - Resin	Natural
Flammability	94V-2
Gender	Dual
Glow-Wire Compliant	No
Material - Resin	Nylon
Number of Rows	2
Packaging Type	Bag
Panel Mount	No
Pitch - Mating Interface (in)	0.198 In
Pitch - Mating Interface (mm)	5.03 mm
Stackable	No
Temperature Range - Operating	-40°C to +105°C

Electrical

Current - Maximum per Contact	11A
-------------------------------	-----

Material Info

Old Part Number	1261-P1
-----------------	---------

Reference - Drawing Numbers

Packaging Specification	PK-1261-001
Product Specification	PS-02-09, PS-43660-9999
Sales Drawing	SD-1261-*

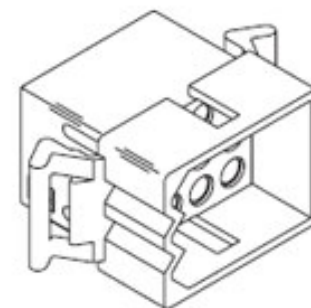

image - Reference only

Series

EU RoHS

ELV and RoHS Compliant
REACH SVHC Contains SVHC: No
Halogen-Free
Status Not Reviewed

China RoHS



Need more information on product environmental compliance?

Email productcompliance@molex.com
 For a multiple part number RoHS Certificate of Compliance, [click here](#)

Please visit the [Contact Us](#) section for any non-product compliance questions.

Search Parts in this Series

[1261Series](#)

Mates With

[1261r](#)

Use With

[1189](#) Crimp Terminals, [1190](#) Crimp Terminals, [1376](#) Male PC Tail Terminals, [1377](#) Female PC Tail Terminals, [1380](#) Male Crimp Terminals, [1381](#) Female Crimp Terminals, [1433](#) Crimp Terminals, [1434](#) Male Crimp Terminals, [1973](#) , [2151](#) , [2273](#) , [2870](#) , [2871](#) , [4272](#) , [4550](#) , [6271](#) , [6310](#) , [42477](#) , [42478](#)

13 12 11 10 9 8 7 6 5 4 3 2 1

J
I
H
G
F
E
D
C
B
A

J
I
H
G
F
E
D
C
B
A

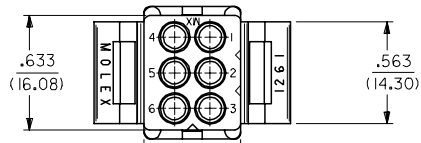

CIRCUIT I.D. (3 PL.)

OPTIONAL MOUNTING EAR (PREBENT SHOWN) & RIB, SEE DETAIL 3 & 4

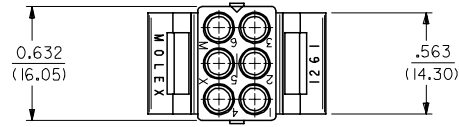
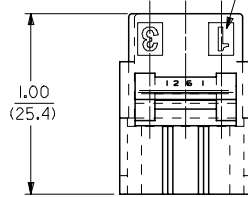
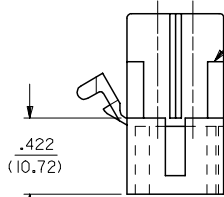
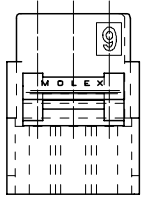

OPTIONAL MOUNTING EAR (PREBENT SHOWN) SEE DETAIL 3 & 4

OPTIONAL LOCK RAMP

CIRCUIT I.D. (3 PL.)

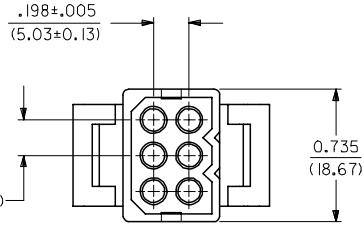
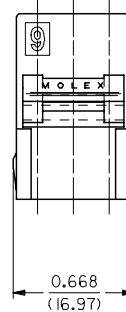
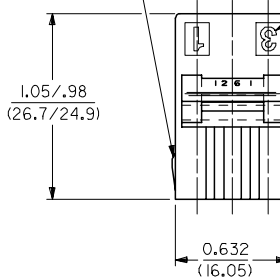
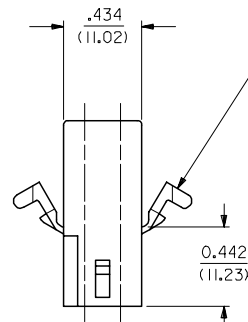

.198±.005 (5.03±0.13) (2 PL.)

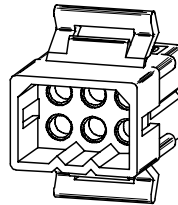

PLUG

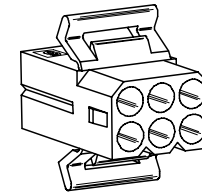
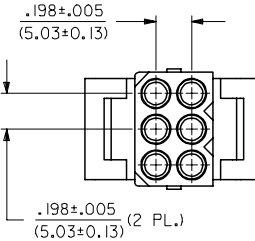

RECEPTACLE

REVISED NOTES EC NO: UCP2006-2424 DRAWN/PRI/DOR 2006/06/08 CHKD: AEL/HAG 2006/06/08 APPR: FSM/TH 2006/06/09	QUALITY SYMBOLS = 0 = 0	GENERAL TOLERANCES (UNLESS SPECIFIED)		DIMENSION STYLE IN/MM	SCALE 2:1	DESIGN UNITS INCH	THIRD ANGLE PROJECTION	
		mm	INCH	DRAWN BY JWC	DATE 11/6/89	TITLE .093/(2.36) HOUSING, PLUG AND RECEPTACLE, 6 CKT., .198/(5.03)CTRS.		
		4 PLACES ± .005	± .005	CHECKED BY RW	DATE 11/6/89	MATERIAL NO. SD-1261-*		
		3 PLACES ± .007	± .007	APPROVED BY JWF	DATE 11/6/89	DOCUMENT NO. SD-1261-*		
2 PLACES ± 0.18	± 0.10	DRAFT WHERE APPLICABLE MUST REMAIN WITHIN DIMENSIONS		SIZE C	SHEET NO. 1 OF 2			
1 PLACE ± 0.25	± .005	THIS DRAWING CONTAINS INFORMATION THAT IS PROPRIETARY TO MOLEX INCORPORATED AND SHOULD NOT BE USED WITHOUT WRITTEN PERMISSION						
ANGULAR ± 2 °		SEE CHART						

12 11 10 9 8 7 6 5 4 3 2 1

PLUG

PART NO.	ENG. NO.
03-09-2061	I261-P
23-09-2061	I261-P-100
03-09-2062	I261-P1
23-09-2062	I261-P1-100
03-09-7061	I261-PBK
03-09-7062	I261-P1BK
27-09-2093	I261-P1-200
50-29-0099	I261-P1-300

RECEPTACLE

PART NO.	ENG. NO.
03-09-1061	I261-R
23-09-1061	I261-R-100
03-09-1062	I261-R1
23-09-1062	I261-R1-100
03-09-1063	I261-R2
23-09-1063	I261-R2-100
03-09-1064	I261-R3
27-09-1063	I261-R2-200
03-09-6064	I261-R3BK
03-09-6063	I261-R2BK
03-09-6062	I261-R1BK
03-09-6061	I261-RBK
50-29-1500	I261-R3-300

LEGEND: PLUG

I261-P***-***
 P = PLUG
 BLANK = PLUG WITH PREBENT MOUNTING EARS
 I = PLUG WITHOUT MOUNTING EARS
 COLOR: BLANK=NATURAL COLOR
 AM=AMBER BK=BLACK BU=BLUE
 BN=BROWN GY=GRAY GN=GREEN
 OR=ORANGE RD=RED YW=YELLOW
 MATERIAL: BLANK = NYLON 6/6, U.L. 94V-2
 100 = POLYPROPYLENE, U.L. 94V-0
 200 = NYLON 6/6, U.L. 94V-0, RED
 300 = NYLON 6/6, U.L. 94V-2, BLACK
 UV RESISTANT

LEGEND: RECEPTACLE

I261-R***-***
 R = RECEPTACLE
 BLANK = WITH STD. MOUNTING EARS, WITH LOCK RAMP
 1 = WITH STD. MOUNTING EARS, WITHOUT LOCK RAMP
 2 = WITHOUT MOUNTING EARS, WITHOUT LOCK RAMP
 3 = WITHOUT MOUNTING EARS, WITH LOCK RAMP
 4 = WITH PREBENT MOUNTING EARS, WITH LOCK RAMP
 5 = WITH PREBENT MOUNTING EARS, WITHOUT LOCK RAMP
 COLOR: BLANK=NATURAL COLOR
 AM=AMBER BK=BLACK BU=BLUE
 BN=BROWN GY=GRAY GN=GREEN
 OR=ORANGE RD=RED YW=YELLOW
 MATERIAL: BLANK = NYLON 6/6, U.L. 94V-2
 100 = POLYPROPYLENE, U.L. 94V-0
 200 = NYLON 6/6, U.L. 94V-0, RED
 300 = NYLON 6/6, U.L. 94V-2, BLACK
 UV RESISTANT

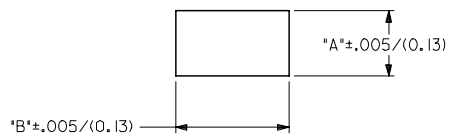
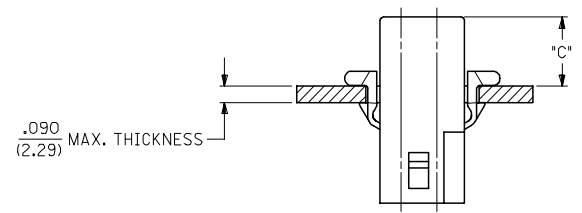

MOUNTING HOLE CUTOUT

HOUSING	DIM. 'A'	DIM. 'B'	DIM. 'C' (STD. EAR)	DIM. 'C' (PREBENT)
PLUG	.750/(19.05)	.695/(17.65)	.39/(9.9)	.40/(10.1)
RECEPTACLE	.718/(18.24)	.600/(15.24)	.40/(10.1)	.41/(10.3)

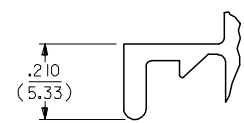

DETAIL 3

.093/(2.36) STANDARD MOUNTING EAR
 (SCALE 4:1)

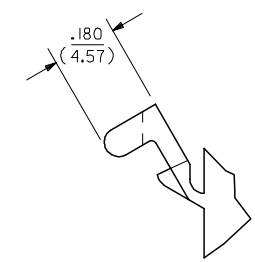
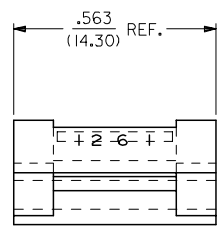

DETAIL 4

.093/(2.36) PREBENT MOUNTING EAR
 (SCALE 4:1)

NOTES:

- MATERIAL: SEE LEGEND
- FINISH: NONE
- PRODUCT SPECIFICATION: PS-43660-9999
- PACKAGING INFORMATION: PK-1261-001
- HOUSINGS FOR USE WITH MOLEX .093/(2.36) PIN AND SOCKET TERMINALS.
- CIRCUIT I.D. NUMBERS ON SIDE OF HOUSING APPEAR ON PARTS FROM TOOLS BUILT AFTER 9/3/91.
- WHERE DENOTED IN CHART, TOOLS ARE BUILT WITH PREBENT MOUNTING EARS PER DETAIL 4 AND SUPERSEDE ALL TOOLS PREVIOUSLY BUILT WITH THE STANDARD MOUNTING EAR.
- TEXT AND CIRCUIT IDENTIFIERS ARE SHOWN IN APPROXIMATE LOCATION BUT MAY VARY TO ACCOMMODATE TOOLING.

UPDATED NOTES EC NO: UCP2006-2424 DRAWN: P. DDER 2006/06/08 CHKD: AELHAG 2006/06/08 APPR: FSM TH 2006/06/09	QUALITY SYMBOLS ▽=0 ▽=0	GENERAL TOLERANCES (UNLESS SPECIFIED)		DIMENSION STYLE IN/MM		SCALE 4:1	DESIGN UNITS INCH	THIRD ANGLE PROJECTION
		4 PLACES ± .005 ± .007 3 PLACES ± .007 ± .010 2 PLACES ± .010 ± .010 1 PLACE ± .025 ± .025 ANGULAR ± 2 °	DRAWN BY GJC DATE 11/10/89	CHECKED BY RW DATE 11/10/89	APPROVED BY GJC DATE 11/10/89	.093/(2.36) HOUSING, PLUG AND RECEPTACLE, 6 CKT., .198/(5.03) CTRS.		
		DRAFT WHERE APPLICABLE MUST REMAIN WITHIN DIMENSIONS		SEE CHART		MOLEX INCORPORATED		
		MATERIAL NO.		DOCUMENT NO.		SHEET NO.		