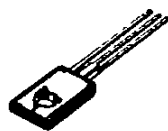

2SC2621

2009A

NPN Triple Diffused Planar
Silicon Transistor

Color TV Chroma Output Applications

©675A

Absolute Maximum Ratings at $T_a=25^\circ\text{C}$

			unit
Collector to Base Voltage	V_{CB0}	300	V
Collector to Emitter Voltage	V_{CE0}	300	V
Emitter to Base Voltage	V_{EBO}	6.5	V
Collector Current	I_C	200	mA
Peak Collector Current	i_{cp}	700	mA
Collector Dissipation	P_C	1.2	W
		$T_c=25^\circ\text{C}$	10
Junction Temperature	T_j	150	$^\circ\text{C}$
Storage Temperature	T_{stg}	-55 to +150	$^\circ\text{C}$

Electrical Characteristics at $T_a=25^\circ\text{C}$

			min	typ	max	unit
Collector Cutoff Current	I_{CB0}	$V_{CB}=200\text{V}, I_E=0$			1.0	μA
Emitter Cutoff Current	I_{EBO}	$V_{EB}=6\text{V}, I_C=0$			1.0	μA
DC Current Gain	h_{FE}	$V_{CE}=10\text{V}, I_C=10\text{mA}$	40*		200*	
Gain Band-width Product	f_T	$V_{CE}=30\text{V}, I_C=10\text{mA}$	50			MHz
Output Capacitance	c_{ob}	$V_{CB}=50\text{V}, f=1\text{MHz}$			5	pF
C-E Saturation Voltage	$V_{CE(sat)}$	$I_C=20\text{mA}, I_B=2\text{mA}$			0.6	V
B-E Saturation Voltage	$V_{BE(sat)}$	$I_C=20\text{mA}, I_B=2\text{mA}$			1.0	V

DataSheet4U.com

* : The 2SC2621 is classified by 10mA h_{FE} as follows :

40	C	80	60	D	120	100	E	200
----	---	----	----	---	-----	-----	---	-----

Case Outline 2009A

(unit:mm)

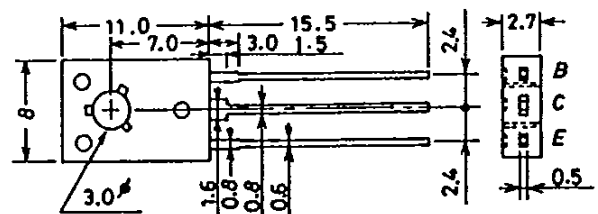

JEDEC: TO-126

B: Base
C: Collector
E: Emitter

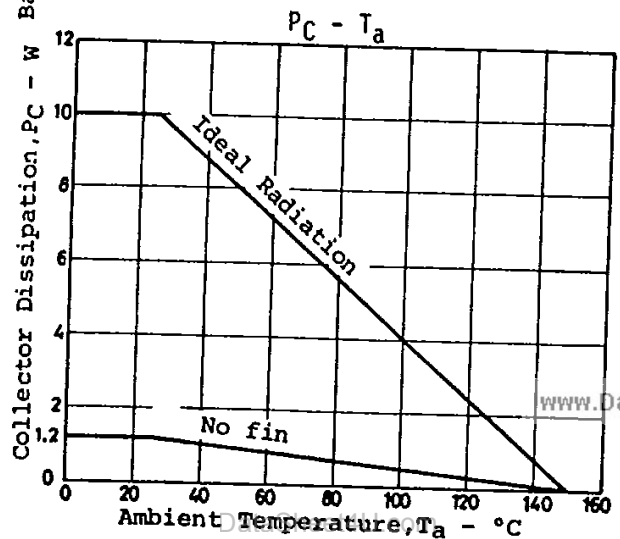
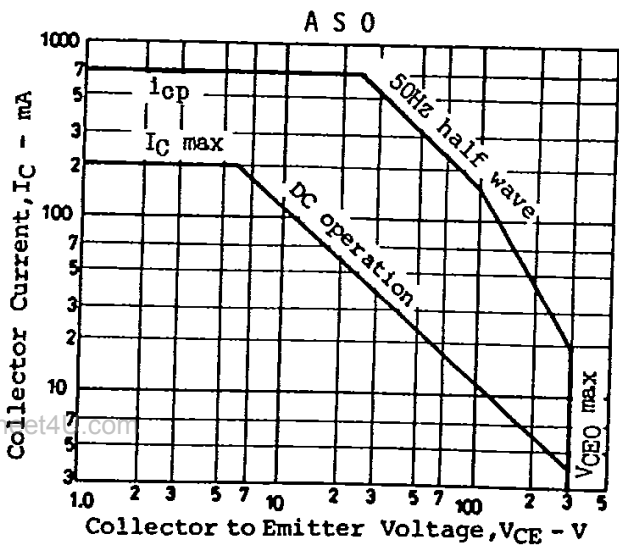
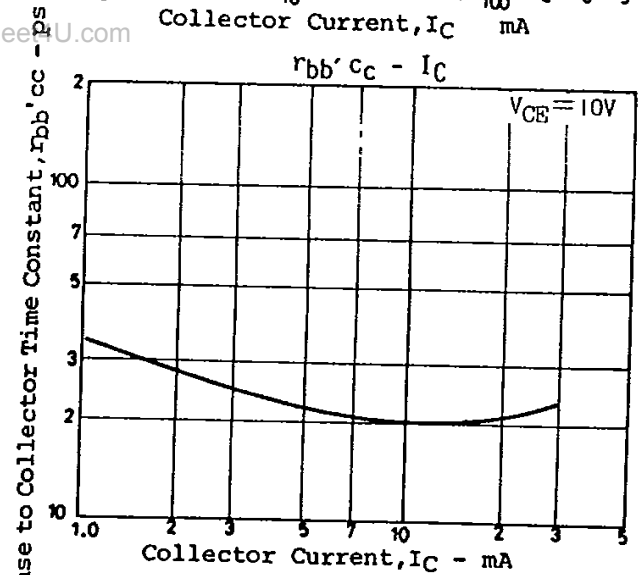
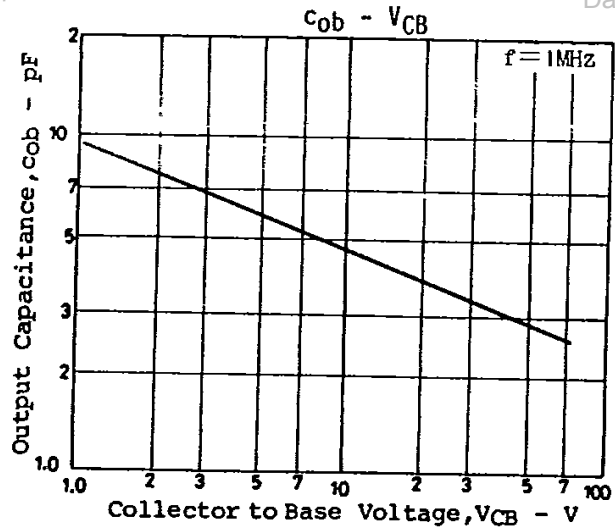
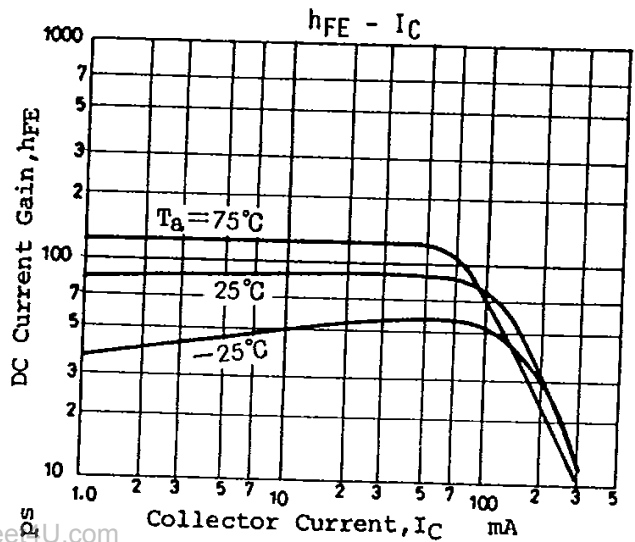
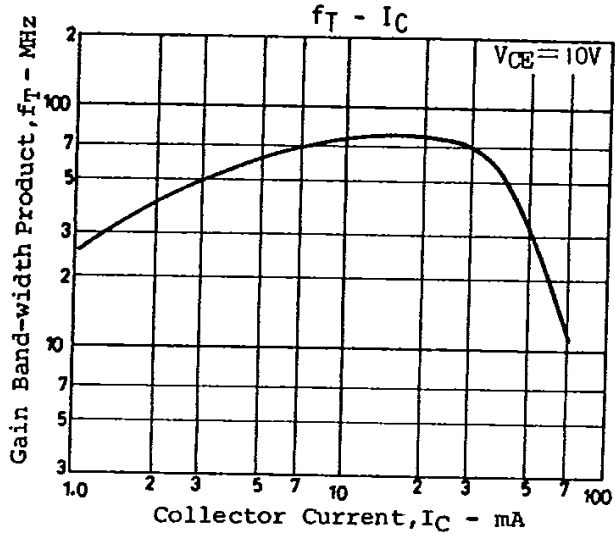
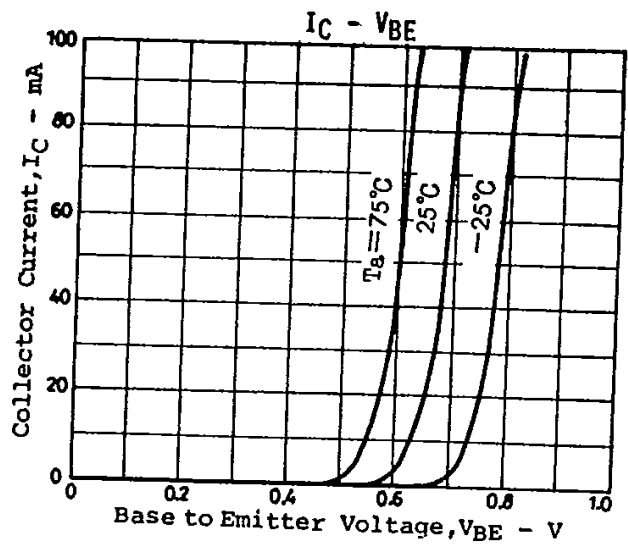
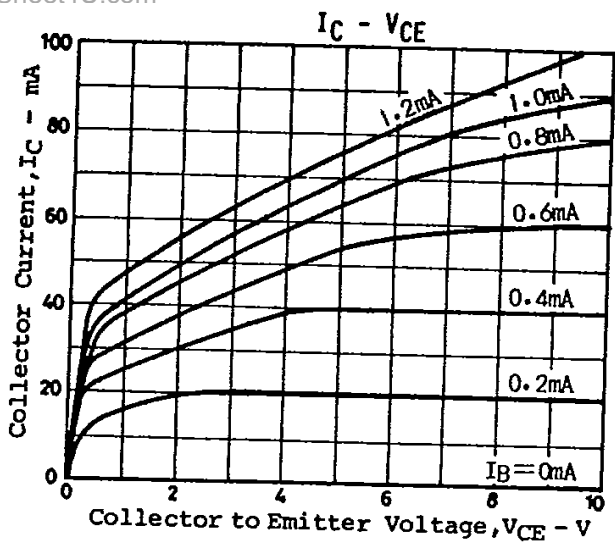

CASE OUTLINES AND ATTACHMENTS

- All of Sanyo Transistor case outlines are illustrated below.
- All dimensions are in mm, and dimensions which are not followed by min. or max. are represented by typical values.
- No marking is indicated.

Case Outline—[2003A]
unit:mm

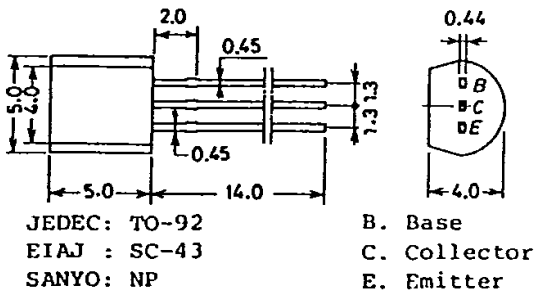

Case Outline—[2009A]
unit:mm

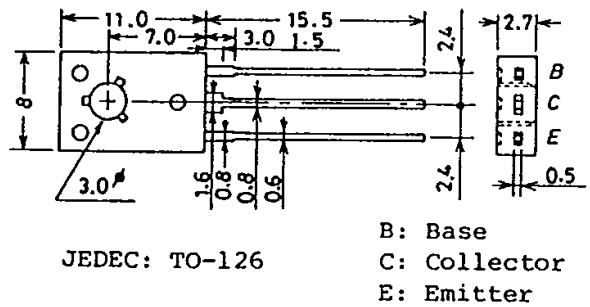

Case Outline—[2004A]
unit:mm

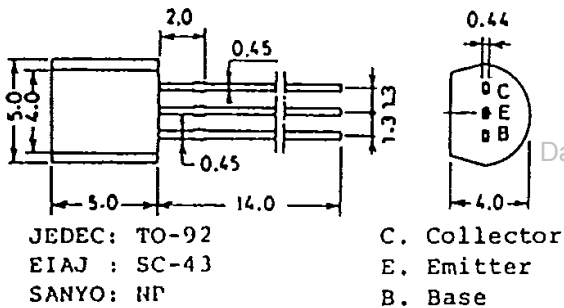

Case Outline—[2010A]
unit:mm

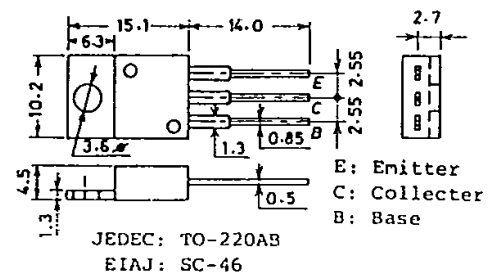

Case Outline—[2005A]
unit:mm

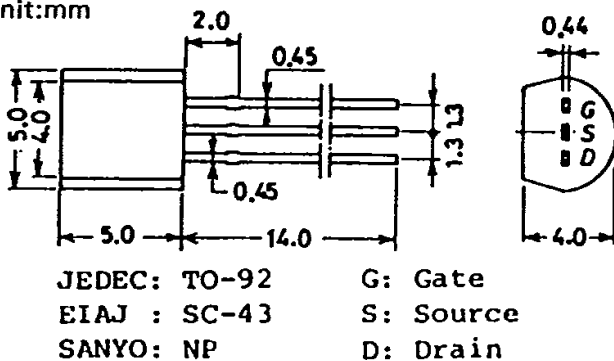

Case Outline—[2012]
unit:mm

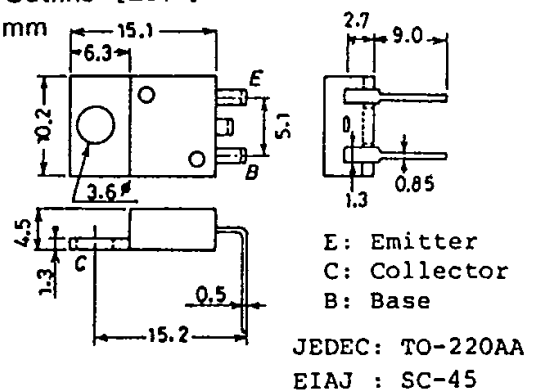

Case Outline—[2006A]
unit:mm

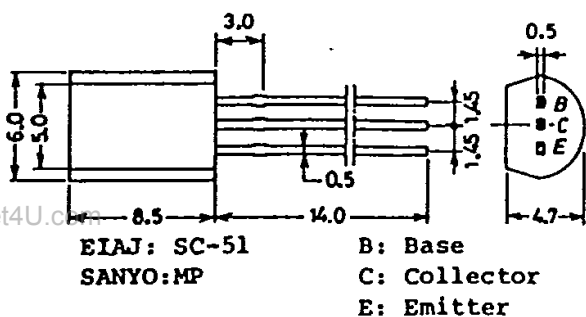

Case Outline—[2013]
unit:mm

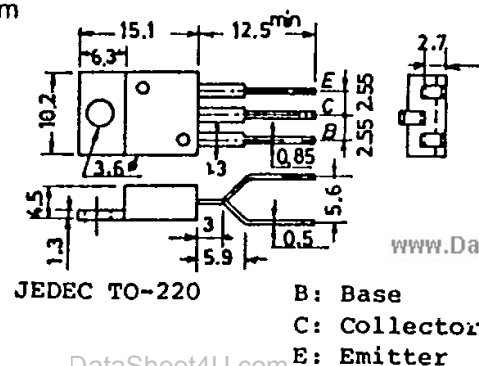

Case Outline-[2017]

unit:mm

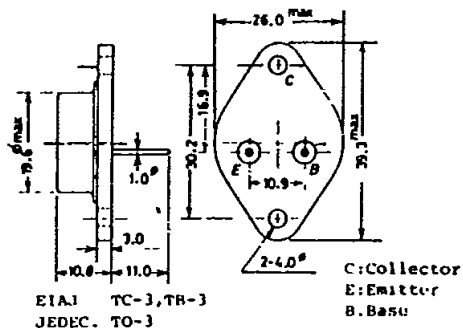

Case Outline-[2025]

unit:mm

T-91-20

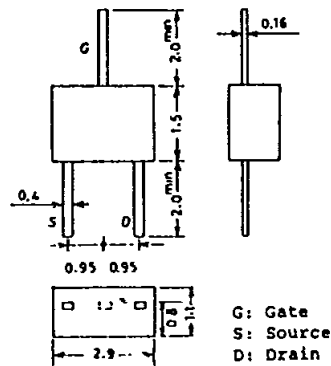

Case Outline-[2018A]

unit:mm

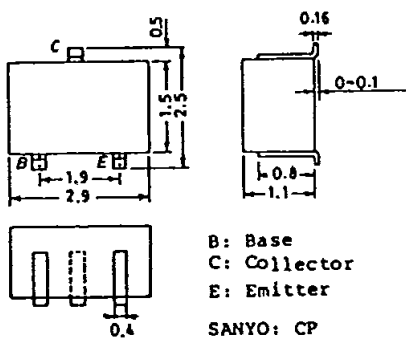

Case Outline-[2026]

unit:mm

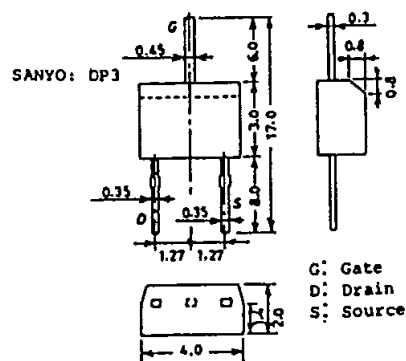

Case Outline-[2019A]

unit:mm

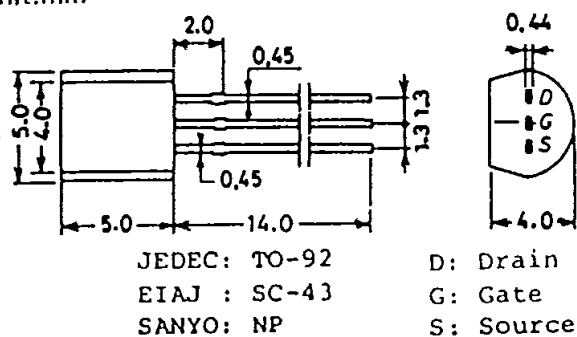

Case Outline-[2027A]

unit:mm

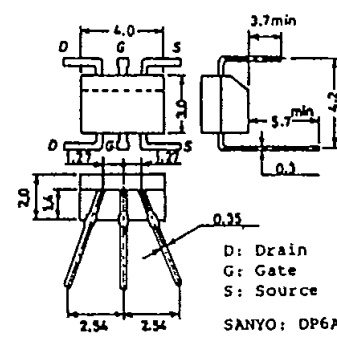

Case Outline-[2022]

unit:mm

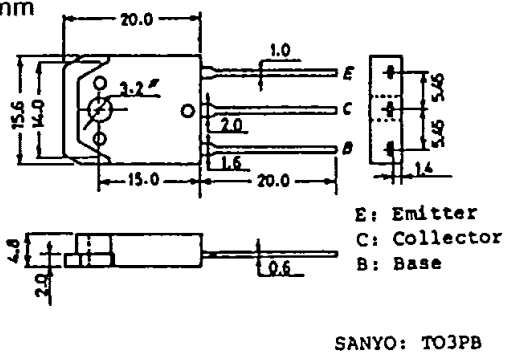

Case Outline-[2028A]

unit:mm

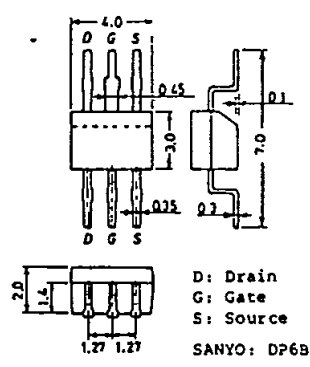

Case Outline-[2024A]

unit:mm

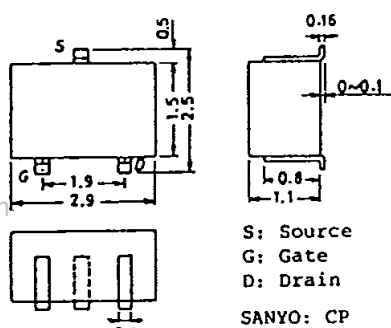

Case Outline-[2029A]

unit:mm

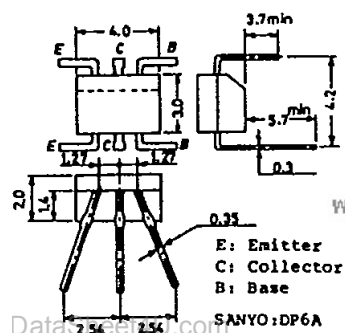

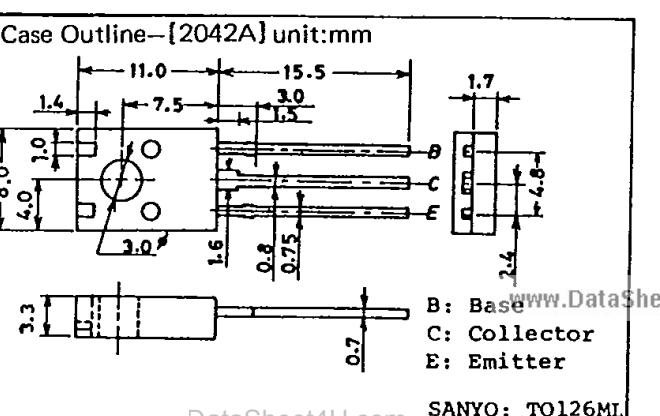
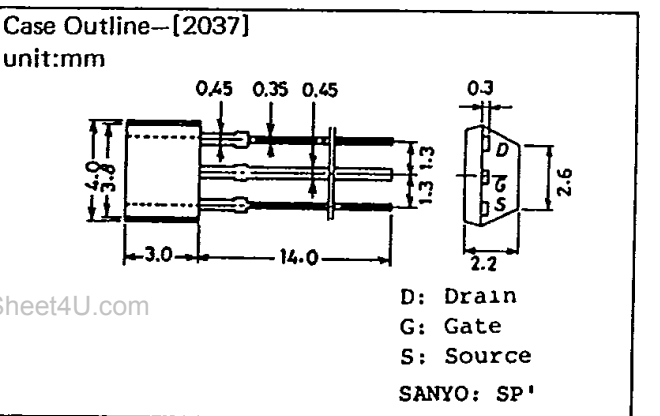
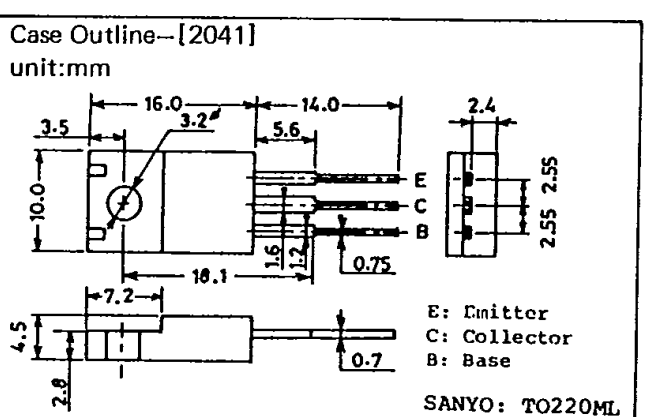
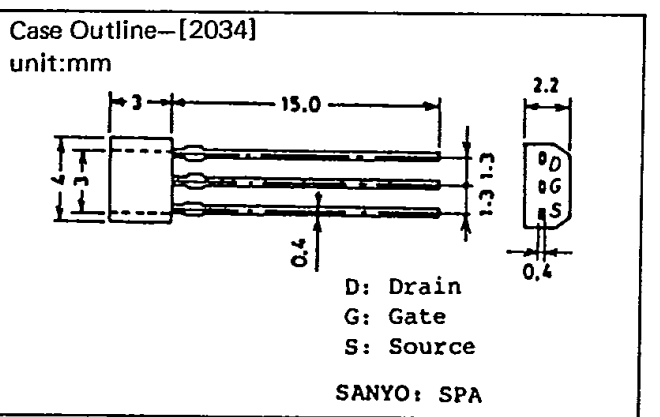
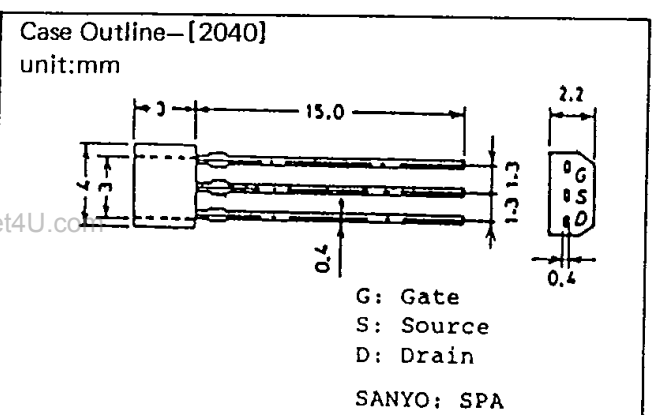
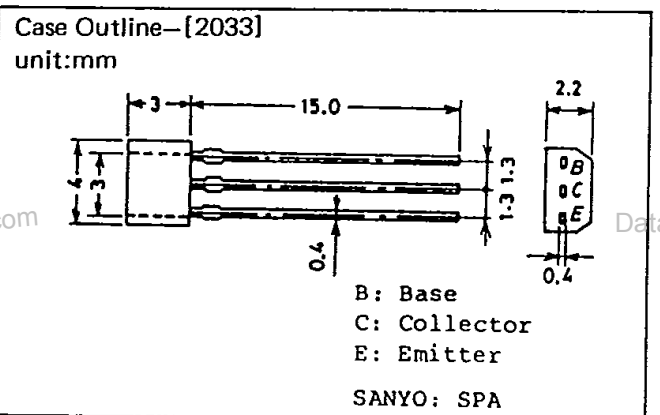
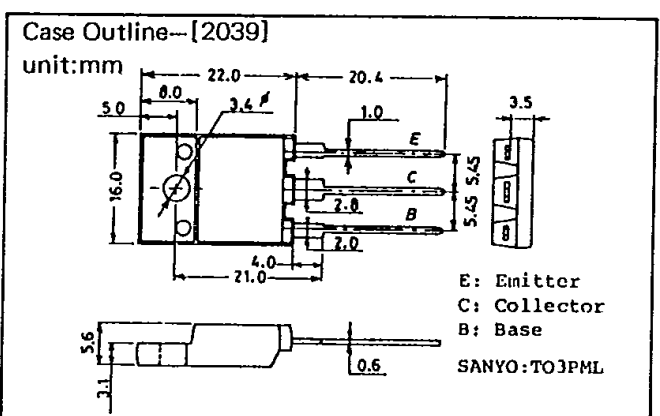
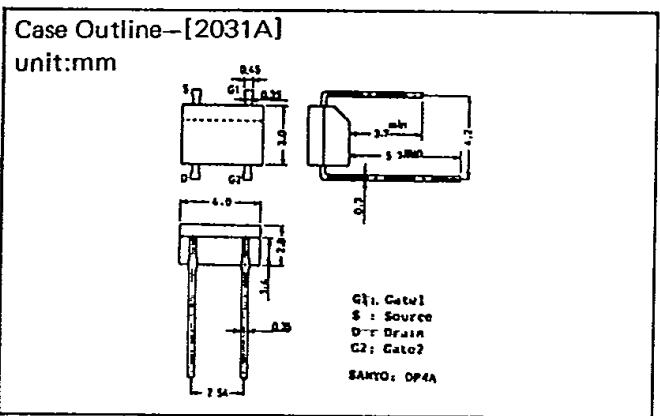
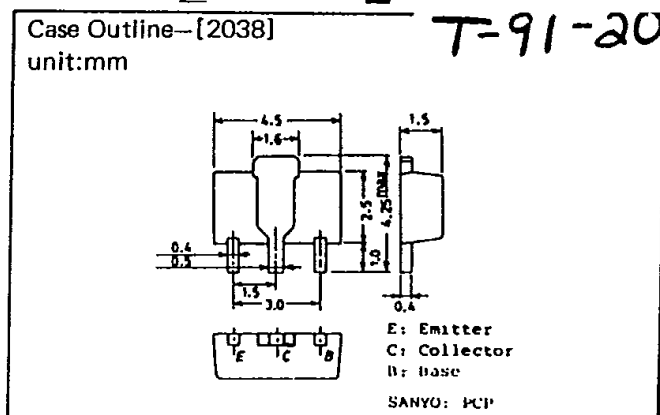
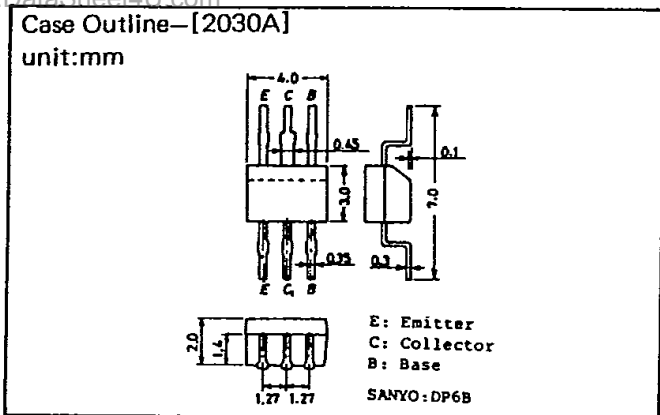

DataSheet4U.com

DataSheet4U.com

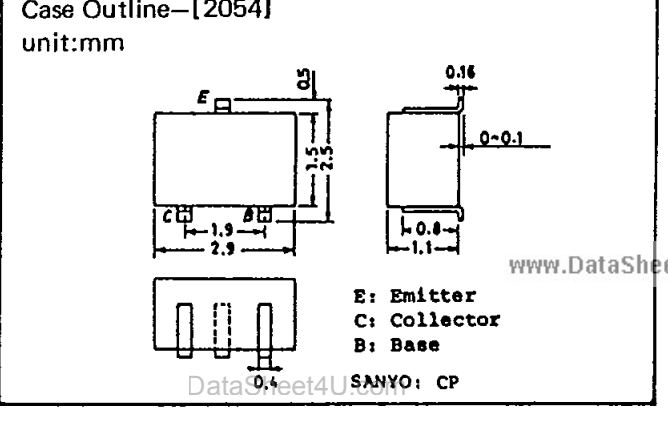
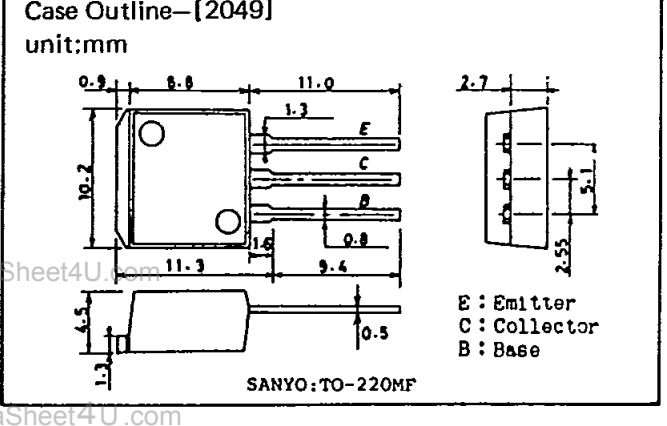
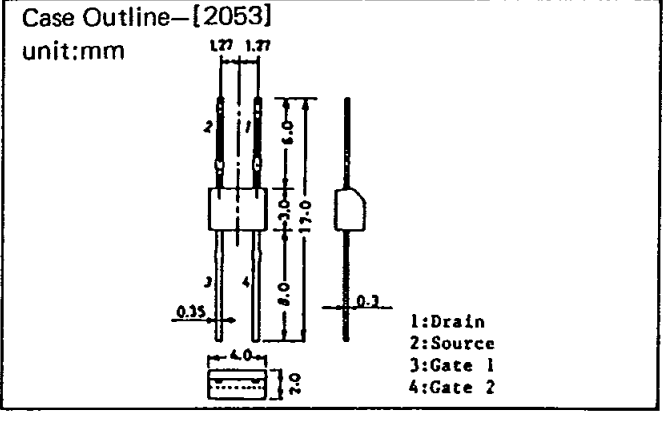
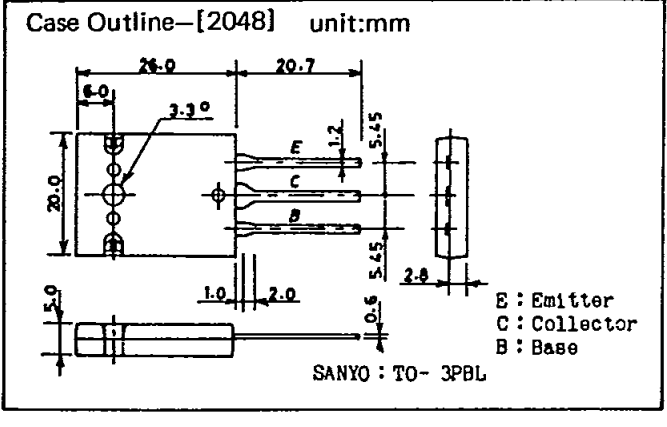
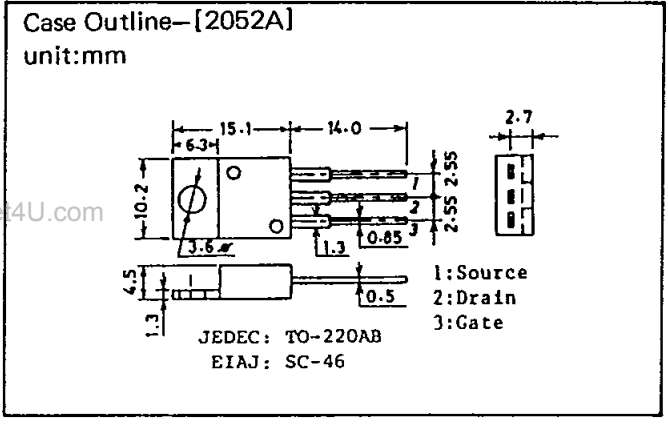
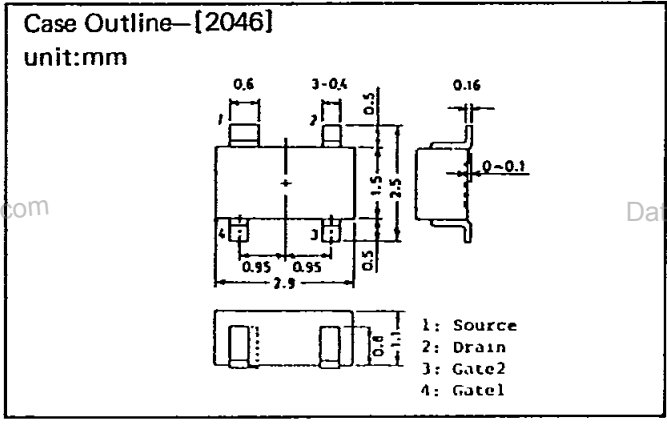
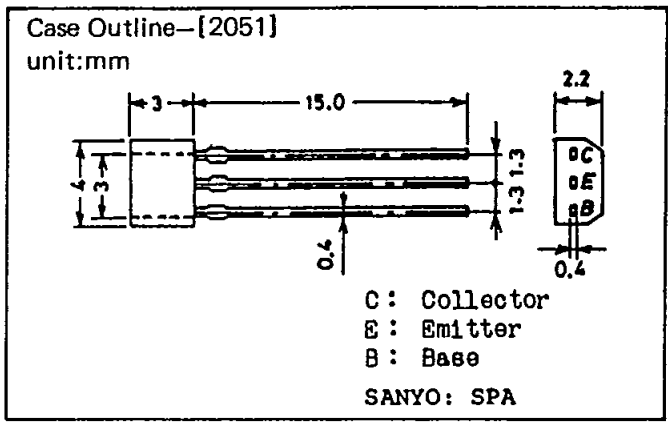
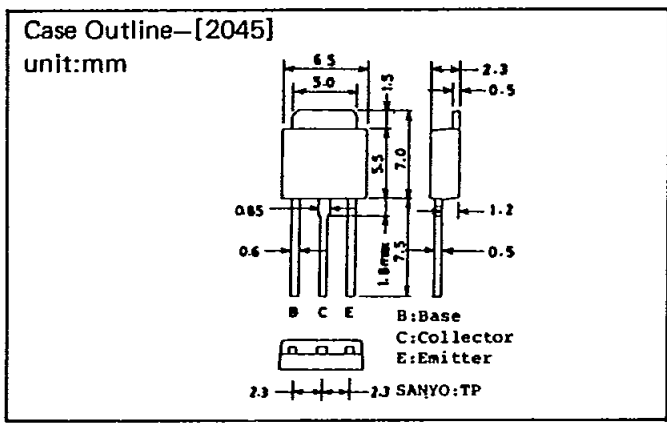
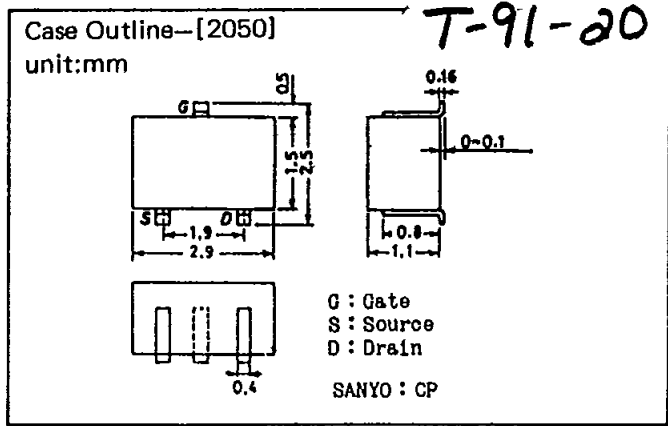
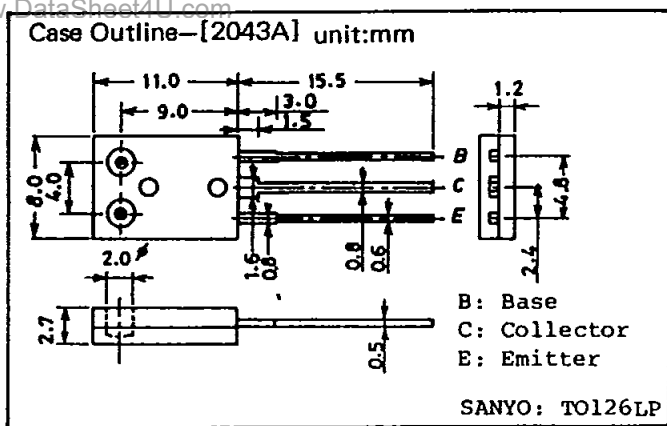

et4U.com

DataSheet4U.com

DataShee

DataSheet4U.com

www.DataSheet4U.com

DataSheet4U.com

DataSheet4U.com

Case Outline-[2056] unit:mm

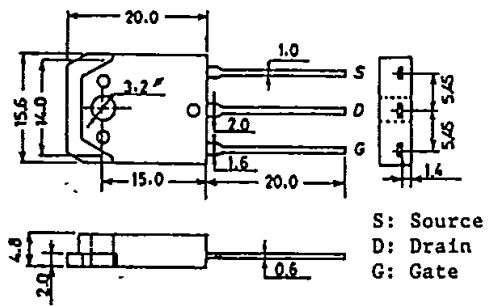

S: Source
D: Drain
G: Gate

SANYO: TO3PB

Case Outline-[0008] unit:mm

T-91-20

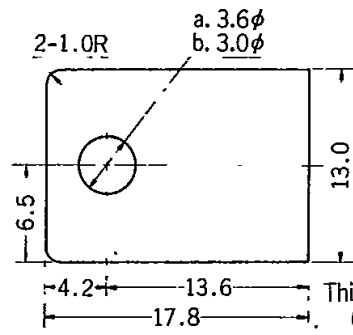

a. IS-313B
b. IS-313D

SANYO

Case Outline-[0004] unit:mm

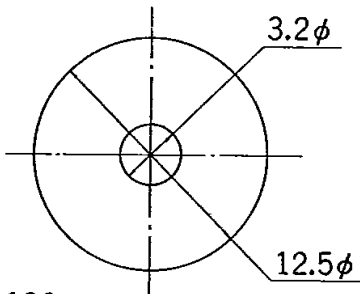

SANYO IS-126

Thickness : 0.075

Case Outline-[0009] unit:mm

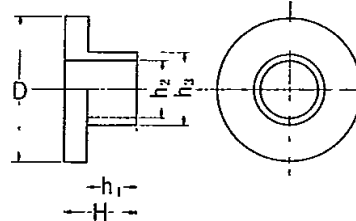

Bush	D	H	h ₁	h ₂	h ₃
A	8.0φ	4.0	2.8	3.1φ	3.89φ
B	8.0φ	3.0	1.8	3.1φ	3.89φ
C	8.0φ	5.7	4.5	3.1φ	3.89φ
D	8.0φ	2.7	1.5	3.1φ	3.89φ
E	8.0φ	3.4	2.2	3.1φ	3.89φ
F	8.0φ	4.0	2.8	3.0φ	3.59φ
K	16.0φ	3.4	1.4	3.1φ	6.0φ
L	6.0φ	3.1	1.5	2.6φ	3.5φ
M	6.0φ	3.1	1.5	3.0φ	3.59φ
P	6.0φ	2.3	1.1	3.0φ	3.59φ

SANYO Bush

Case Outline-[0005] unit:mm

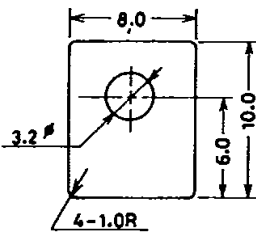

Thickness : 0.075

SANYO IS-126A Mica

Case Outline-[0010] unit:mm

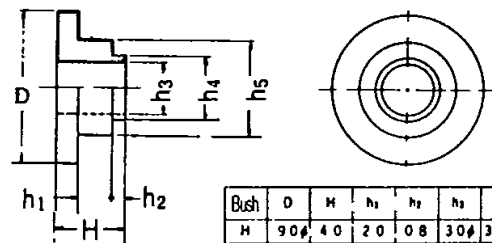

Bush	D	H	h ₁	h ₂	h ₃	h ₄	h ₅
H	9.0φ	4.0	2.0	0.8	3.0φ	3.59φ	5.6φ
T	9.0φ	5.8	2.0	2.6	3.0φ	3.59φ	5.6φ
UB	16.0φ	6.8	1.5	3.3	3.0φ	3.89φ	8.0φ

SANYO Bush

Case Outline-[0006] unit:mm

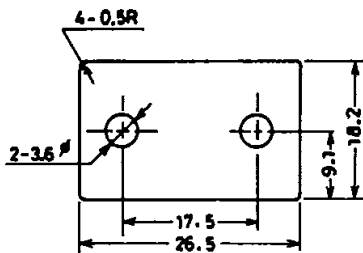

Thickness : 0.05~0.1

SANYO IS-20MA Mica

Case Outline-[0011] unit:mm

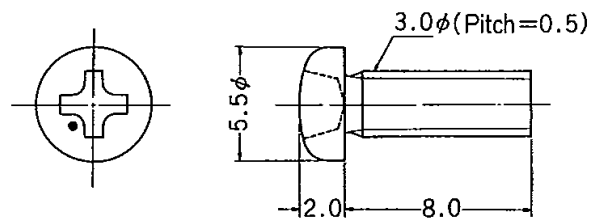

JIS No. B1111 M3×0.5

Case Outline-[0007] unit:mm

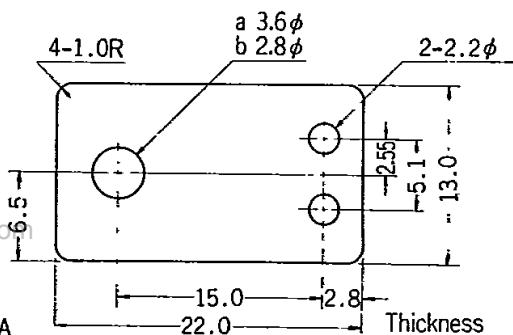

a. IS-313
b. IS-313A

Thickness
0.10~0.05

Case Outline-[0012] unit:mm

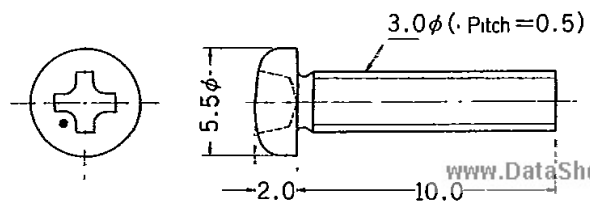

JIS No. B1111 M3×0.5

Case Outline-[0013]

unit:mm

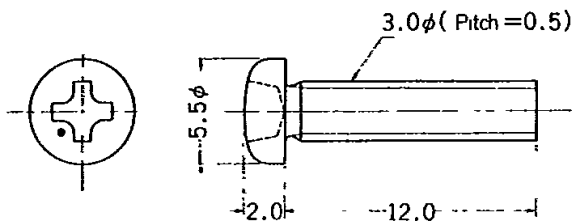

JIS No.B1111 M3×0.5

Case Outline-[0018]

unit:mm

T-91-20

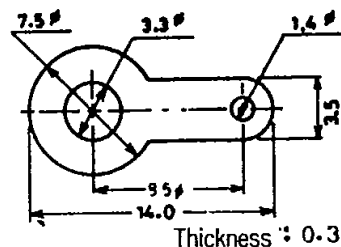

SANYO Lug 1.4

Case Outline-[0014]

unit:mm

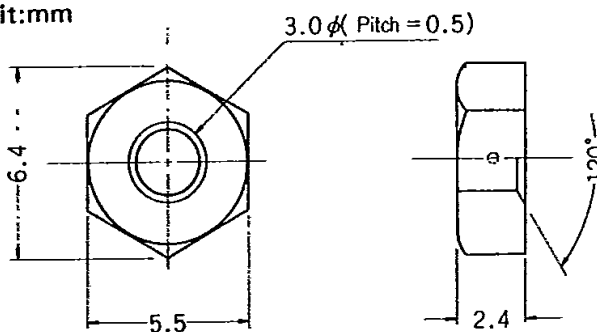

JIS No. B1181 M3×0.5

Case Outline-[0019]

unit:mm

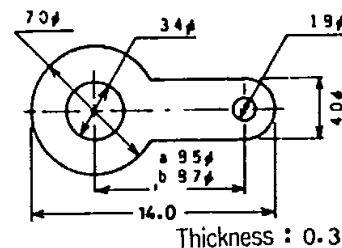

SANYO Lug 1.8φ

Case Outline-[0015]

unit:mm

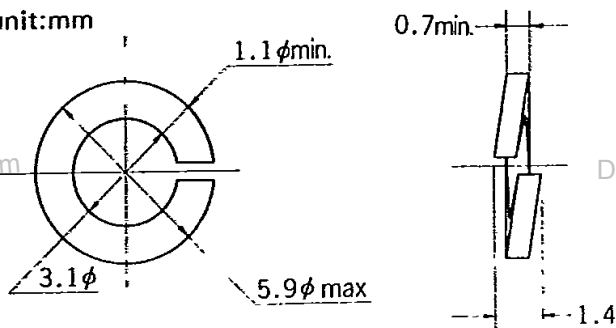

JIS No. B 1251 Spring washer (M3)

Case Outline-[0020]

unit:mm

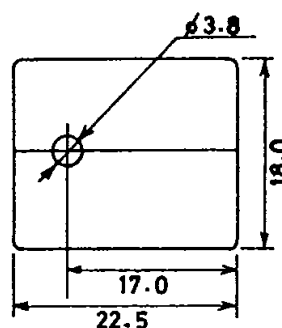

SANYO IS-3MP Mica

Case Outline-[0016]

unit:mm

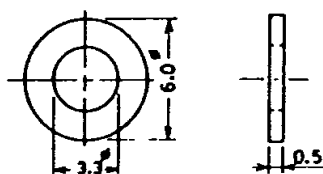

JIS No.B1252 Flat washer

Case Outline-[0021]

unit:mm

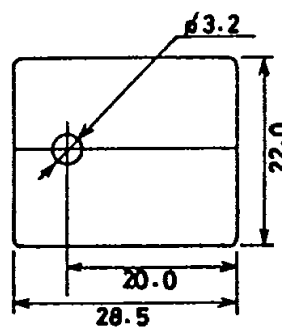

SANYO IS-MPC Mica

Case Outline-[0017]

unit:mm

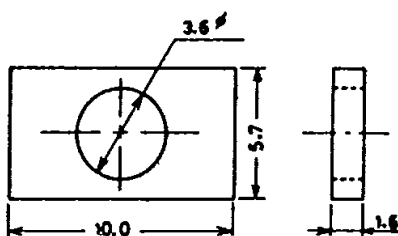

JIS No.G3141 Rectangular washer

Case Outline-[0022]

unit:mm

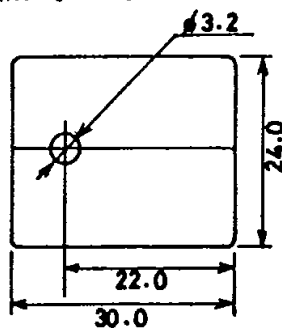

SANYO IS-3PBL Mica