

# BCR3PM

LOW POWER USE

INSULATED TYPE, PLANAR PASSIVATION TYPE

Refer to the page 6 as to the product guaranteed maximum junction temperature 150°C

**BCR3PM**



- **IT (RMS)** ..... **3A**
- **VDRM** ..... **600V**
- **IFGT I, IRGT I, IRGT III** ..... **20mA (10mA) \*5**
- **Viso** ..... **2000V**
- **UL Recognized: Yellow Card No.E80276(N)**

**File No. E80271**

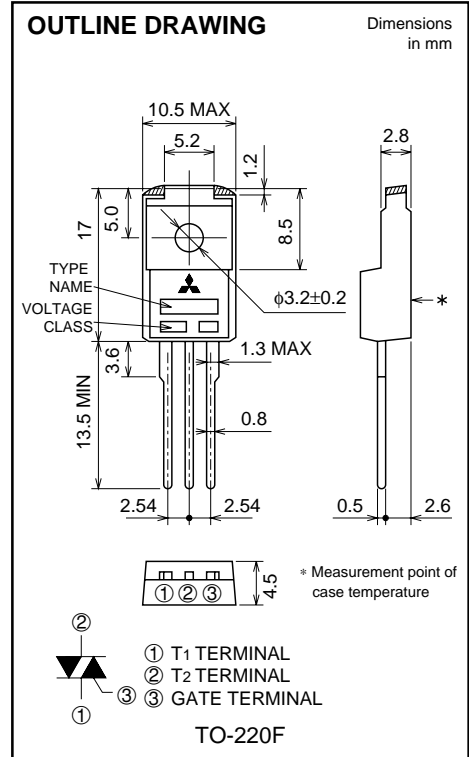

## APPLICATION

Contactless AC switches, light dimmer, electric blankets, control of household equipment such as electric fan, solenoid drivers, small motor control, other general purpose control applications

## MAXIMUM RATINGS

Symbol	Parameter	Voltage class		Unit
		12		
VDRM	Repetitive peak off-state voltage *1	600		V
VDSM	Non-repetitive peak off-state voltage *1	720		V

Symbol	Parameter	Conditions	Ratings	Unit
IT (RMS)	RMS on-state current	Commercial frequency, sine full wave 360° conduction, Tc=107°C	3.0	A
ITSM	Surge on-state current	60Hz sinewave 1 full cycle, peak value, non-repetitive	30	A
I <sup>2</sup> <sub>t</sub>	I <sup>2</sup> <sub>t</sub> for fusing	Value corresponding to 1 cycle of half wave 60Hz, surge on-state current	3.7	A <sup>2</sup> s
PGM	Peak gate power dissipation		3	W
PG (AV)	Average gate power dissipation		0.3	W
VGM	Peak gate voltage		6	V
IGM	Peak gate current		0.5	A
T <sub>j</sub>	Junction temperature		-40 ~ +125	°C
T <sub>stg</sub>	Storage temperature		-40 ~ +125	°C
—	Weight	Typical value	2.0	g
Viso	Isolation voltage	Ta=25°C, AC 1 minute, T1 · T2 · G terminal to case	2000	V

\*1. Gate open.

**BCR3PM**

Refer to the page 6 as to the product guaranteed maximum junction temperature 150°C

**LOW POWER USE**  
**INSULATED TYPE, PLANAR PASSIVATION TYPE**

**ELECTRICAL CHARACTERISTICS**

Symbol	Parameter	Test conditions	Limits			Unit	
			Min.	Typ.	Max.		
IDRM	Repetitive peak off-state current	T <sub>j</sub> =125°C, V <sub>DRM</sub> applied	—	—	2.0	mA	
V <sub>TM</sub>	On-state voltage	T <sub>c</sub> =25°C, I <sub>TM</sub> =4.5A, Instantaneous measurement	—	—	1.5	V	
V <sub>FGT I</sub>	Gate trigger voltage *2	T <sub>j</sub> =25°C, V <sub>D</sub> =6V, R <sub>L</sub> =6Ω, R <sub>G</sub> =330Ω	I	—	—	1.5	V
V <sub>RGT I</sub>			II	—	—	1.5	V
V <sub>RGT III</sub>			III	—	—	1.5	V
I <sub>FGT I</sub>	Gate trigger current *2	T <sub>j</sub> =25°C, V <sub>D</sub> =6V, R <sub>L</sub> =6Ω, R <sub>G</sub> =330Ω	I	—	—	20*5	mA
I <sub>RGT I</sub>			II	—	—	20*5	mA
I <sub>RGT III</sub>			III	—	—	20*5	mA
V <sub>GD</sub>	Gate non-trigger voltage	T <sub>j</sub> =125°C, V <sub>D</sub> =1/2V <sub>DRM</sub>	0.2	—	—	V	
R <sub>th (j-c)</sub>	Thermal resistance	Junction to case *3	—	—	4.5	°C/W	
(dv/dt) <sub>c</sub>	Critical-rate of rise of off-state commutating voltage *4	T <sub>j</sub> =125°C	5	—	—	V/μs	

\*2. Measurement using the gate trigger characteristics measurement circuit.

\*3. The contact thermal resistance R<sub>th (c-f)</sub> in case of greasing is 0.5°C/W.

\*4. Test conditions of the critical-rate of rise of off-state commutating voltage is shown in the table below.

\*5. High sensitivity (I<sub>GT</sub>≤10mA) is also available. (IGT item①)

Test conditions	Commutating voltage and current waveforms (inductive load)
1. Junction temperature T <sub>j</sub> =125°C  2. Rate of decay of on-state commutating current (di/dt) <sub>c</sub> =-1.5A/ms  3. Peak off-state voltage V <sub>D</sub> =400V	

**PERFORMANCE CURVES**

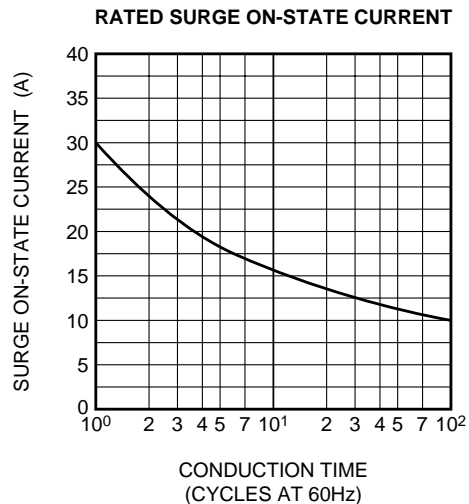
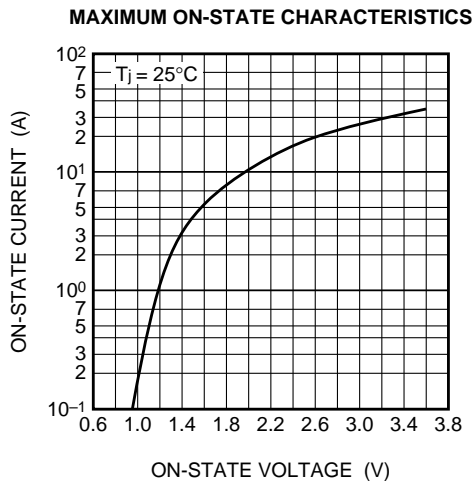

# BCR3PM

Refer to the page 6 as to the product guaranteed maximum junction temperature 150°C

LOW POWER USE  
INSULATED TYPE, PLANAR PASSIVATION TYPE

**GATE CHARACTERISTICS  
(I, II AND III)**

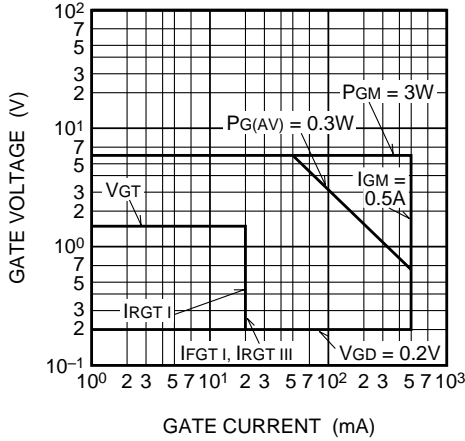

**GATE TRIGGER CURRENT VS.  
JUNCTION TEMPERATURE**

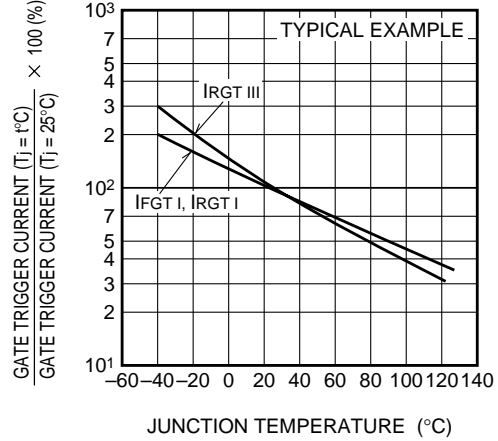

**GATE TRIGGER VOLTAGE VS.  
JUNCTION TEMPERATURE**

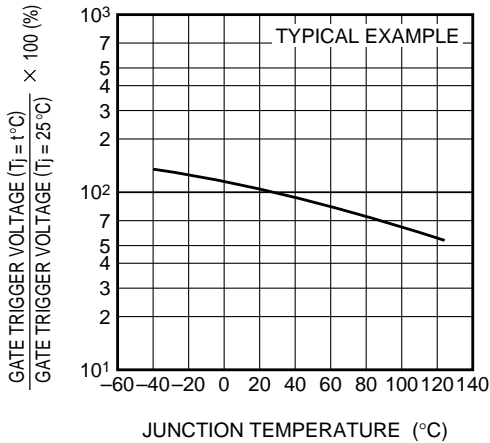

**MAXIMUM TRANSIENT THERMAL  
IMPEDANCE CHARACTERISTICS  
(JUNCTION TO CASE)**

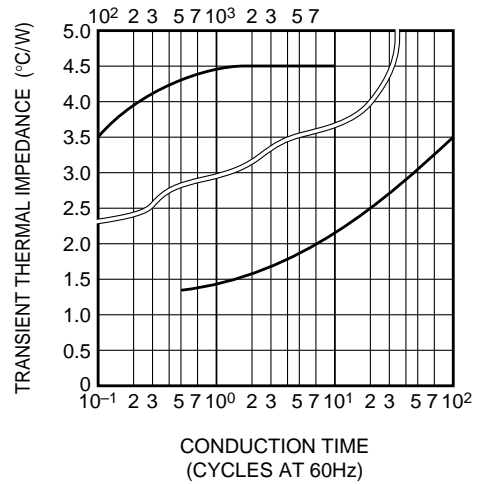

**MAXIMUM ON-STATE POWER  
DISSIPATION**

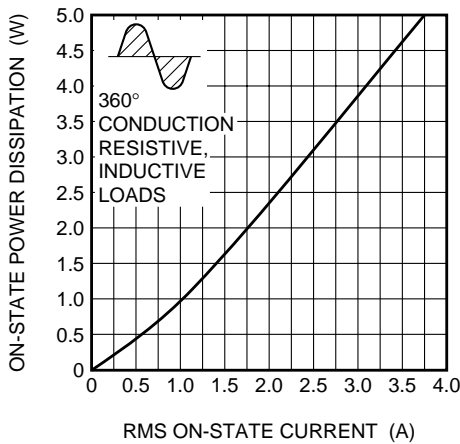

**ALLOWABLE CASE TEMPERATURE  
VS. RMS ON-STATE CURRENT**

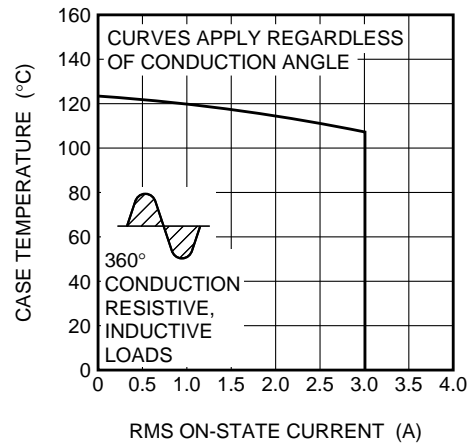

**BCR3PM**

Refer to the page 6 as to the product guaranteed maximum junction temperature 150°C

**LOW POWER USE**  
**INSULATED TYPE, PLANAR PASSIVATION TYPE**

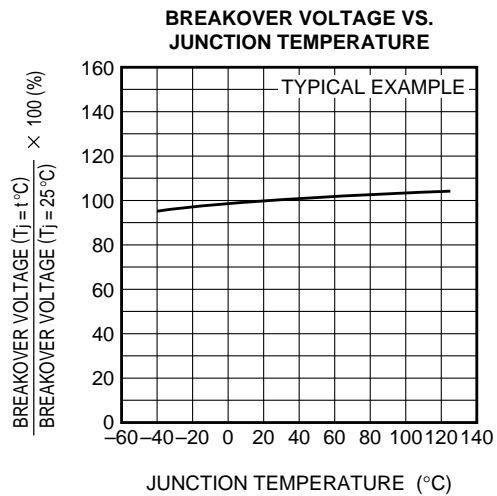
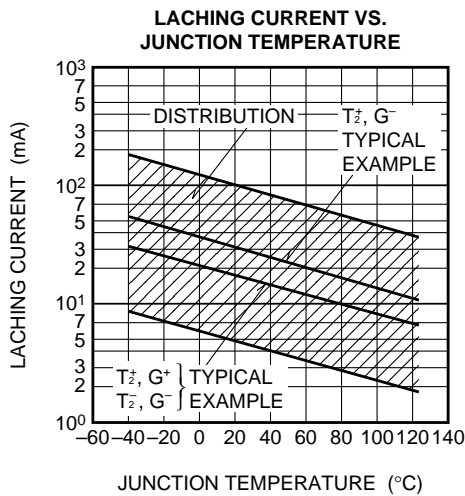
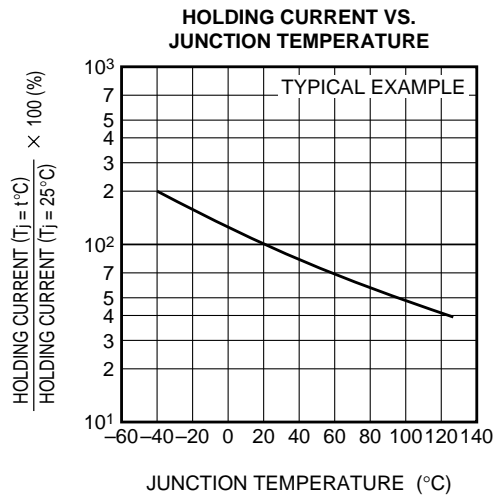
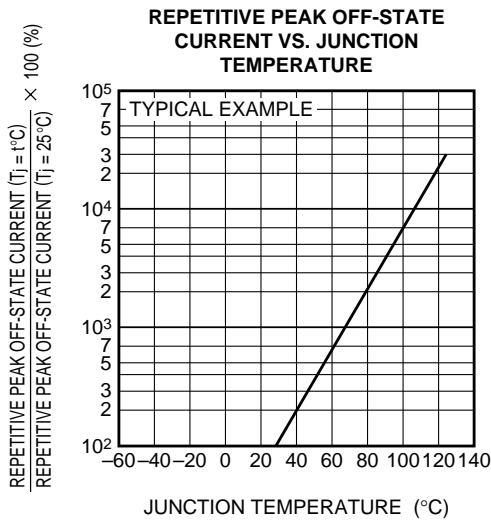
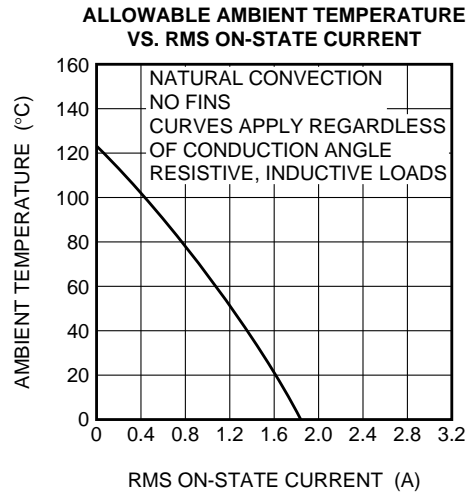
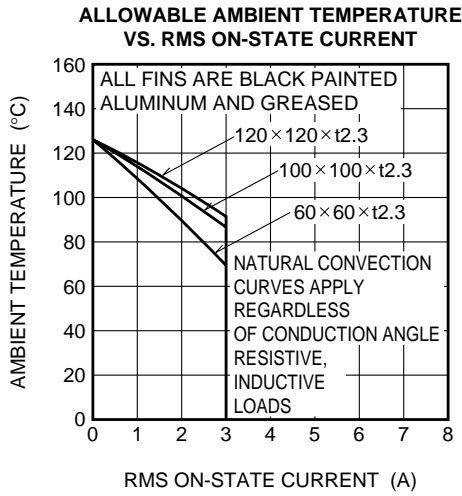

# BCR3PM

Refer to the page 6 as to the product guaranteed maximum junction temperature 150°C

LOW POWER USE  
INSULATED TYPE, PLANAR PASSIVATION TYPE

**BREAKOVER VOLTAGE VS. RATE OF RISE OF OFF-STATE VOLTAGE**

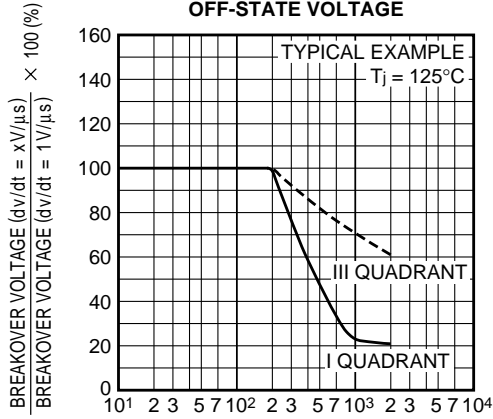

RATE OF RISE OF OFF-STATE VOLTAGE (V/μs)

**COMMUTATION CHARACTERISTICS**

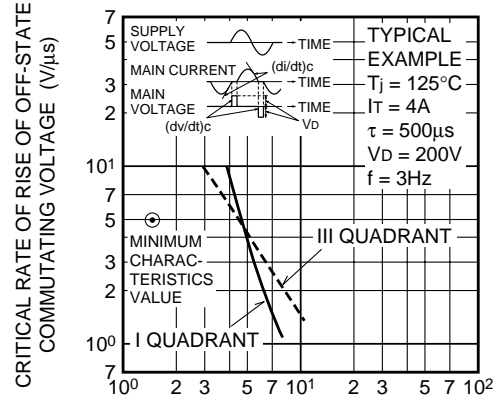

RATE OF DECAY OF ON-STATE COMMUTATING CURRENT (A/ms)

**GATE TRIGGER CURRENT VS. GATE CURRENT PULSE WIDTH**

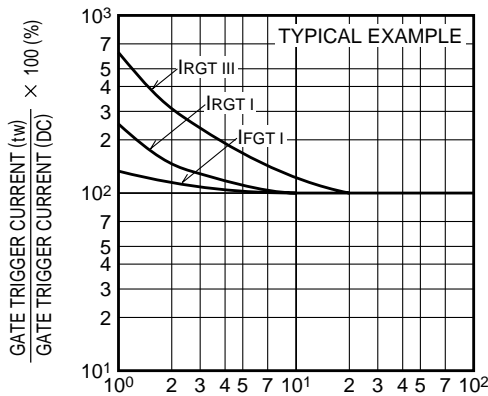

GATE CURRENT PULSE WIDTH (μs)

**GATE TRIGGER CHARACTERISTICS TEST CIRCUITS**

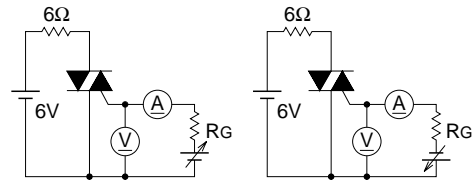

TEST PROCEDURE I

TEST PROCEDURE II

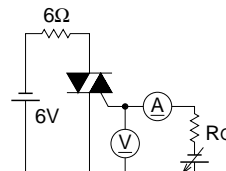

TEST PROCEDURE III

# BCR3PM

LOW POWER USE

INSULATED TYPE, PLANAR PASSIVATION TYPE

The product guaranteed maximum junction temperature 150°C (See warning.)

**BCR3PM**



- **IT (RMS)** ..... **3A**
- **VDRM** ..... **600V**
- **IFGT I, IRGT I, IRGT III** ..... **20mA (10mA) \*5**
- **Viso** ..... **2000V**
- **UL Recognized: Yellow Card No.E80276(N)**

**File No. E80271**

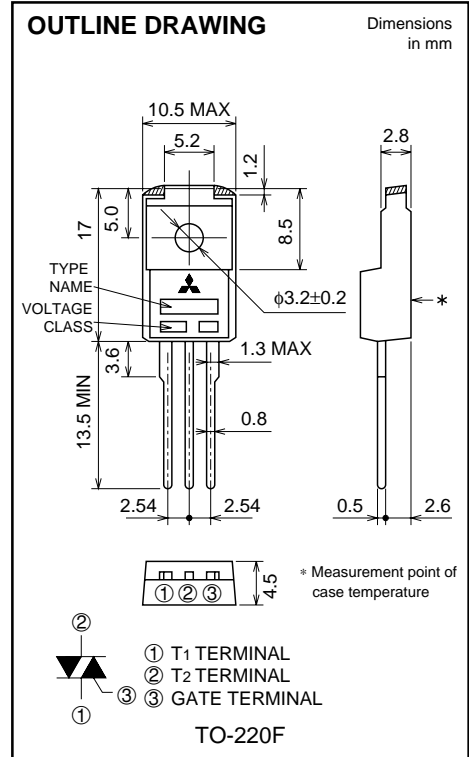

## APPLICATION

Contactless AC switches, light dimmer, electric blankets, control of household equipment such as electric fan, solenoid drivers, small motor control, other general purpose control applications

(Warning)

1. Refer to the recommended circuit values around the triac before using.
2. Be sure to exchange the specification before using. If not exchanged, general triacs will be supplied.

## MAXIMUM RATINGS

Symbol	Parameter	Voltage class		Unit
		12		
VDRM	Repetitive peak off-state voltage *1	600		V
VDSM	Non-repetitive peak off-state voltage *1	720		V

Symbol	Parameter	Conditions	Ratings	Unit
IT (RMS)	RMS on-state current	Commercial frequency, sine full wave 360° conduction, Tc=132°C	3.0	A
ITSM	Surge on-state current	60Hz sinewave 1 full cycle, peak value, non-repetitive	30	A
I <sup>2</sup> <sub>t</sub>	I <sup>2</sup> <sub>t</sub> for fusing	Value corresponding to 1 cycle of half wave 60Hz, surge on-state current	3.7	A <sup>2</sup> s
PGM	Peak gate power dissipation		3	W
PG (AV)	Average gate power dissipation		0.3	W
VGM	Peak gate voltage		6	V
IGM	Peak gate current		0.5	A
T <sub>j</sub>	Junction temperature		-40 ~ +150	°C
T <sub>stg</sub>	Storage temperature		-40 ~ +150	°C
—	Weight	Typical value	2.0	g
Viso	Isolation voltage	Ta=25°C, AC 1 minute, T1 · T2 · G terminal to case	2000	V

\*1. Gate open.

**BCR3PM**

The product guaranteed maximum junction temperature 150°C (See warning.)

**LOW POWER USE**  
**INSULATED TYPE, PLANAR PASSIVATION TYPE**

**ELECTRICAL CHARACTERISTICS**

Symbol	Parameter	Test conditions	Limits			Unit	
			Min.	Typ.	Max.		
IDRM	Repetitive peak off-state current	T <sub>j</sub> =150°C, V <sub>DRM</sub> applied	—	—	2.0	mA	
V <sub>TM</sub>	On-state voltage	T <sub>c</sub> =25°C, I <sub>TM</sub> =4.5A, Instantaneous measurement	—	—	1.5	V	
V <sub>FGT I</sub>	Gate trigger voltage *2	T <sub>j</sub> =25°C, V <sub>D</sub> =6V, R <sub>L</sub> =6Ω, R <sub>G</sub> =330Ω	I	—	—	1.5	V
V <sub>RGT I</sub>			II	—	—	1.5	V
V <sub>RGT III</sub>			III	—	—	1.5	V
I <sub>FGT I</sub>	Gate trigger current *2	T <sub>j</sub> =25°C, V <sub>D</sub> =6V, R <sub>L</sub> =6Ω, R <sub>G</sub> =330Ω	I	—	—	20*5	mA
I <sub>RGT I</sub>			II	—	—	20*5	mA
I <sub>RGT III</sub>			III	—	—	20*5	mA
V <sub>GD</sub>	Gate non-trigger voltage	T <sub>j</sub> =125°C/150°C, V <sub>D</sub> =1/2V <sub>DRM</sub>	0.2/0.1	—	—	V	
R <sub>th (j-c)</sub>	Thermal resistance	Junction to case *3	—	—	4.5	°C/W	
(dv/dt) <sub>c</sub>	Critical-rate of rise of off-state commutating voltage *4	T <sub>j</sub> =125°C/150°C	5/1	—	—	V/μs	

\*2. Measurement using the gate trigger characteristics measurement circuit.  
 \*3. The contact thermal resistance R<sub>th (c-f)</sub> in case of greasing is 0.5°C/W.  
 \*4. Test conditions of the critical-rate of rise of off-state commutating voltage is shown in the table below.  
 \*5. High sensitivity (I<sub>GT</sub>≤10mA) is also available. (IGT item①)

Test conditions	Commutating voltage and current waveforms (inductive load)
1. Junction temperature T <sub>j</sub> =125°C/150°C  2. Rate of decay of on-state commutating current (di/dt) <sub>c</sub> =-1.5A/ms  3. Peak off-state voltage V <sub>D</sub> =400V	

**PERFORMANCE CURVES**

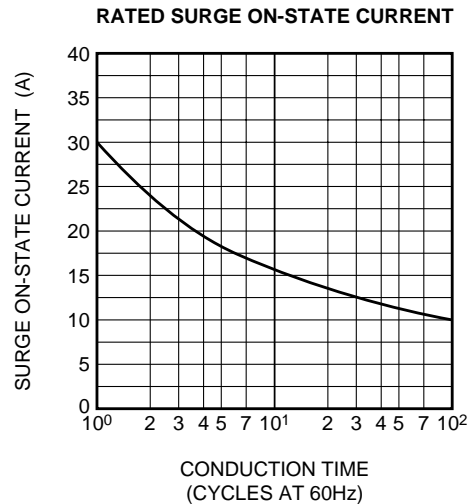
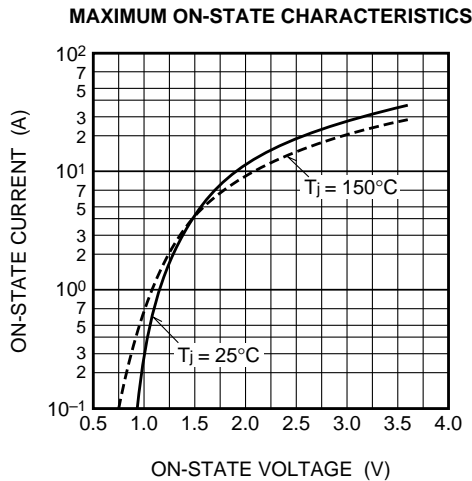

# BCR3PM

The product guaranteed maximum junction temperature 150°C (See warning.)

LOW POWER USE  
INSULATED TYPE, PLANAR PASSIVATION TYPE

**GATE CHARACTERISTICS (I, II AND III)**

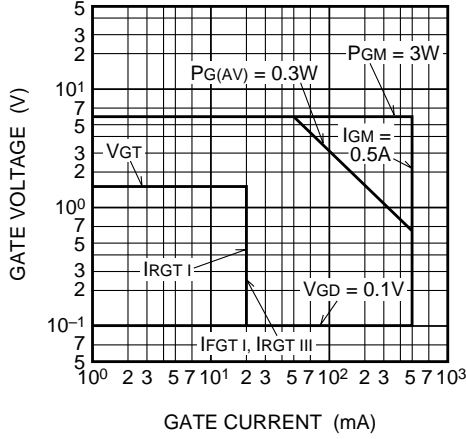

**GATE TRIGGER CURRENT VS. JUNCTION TEMPERATURE**

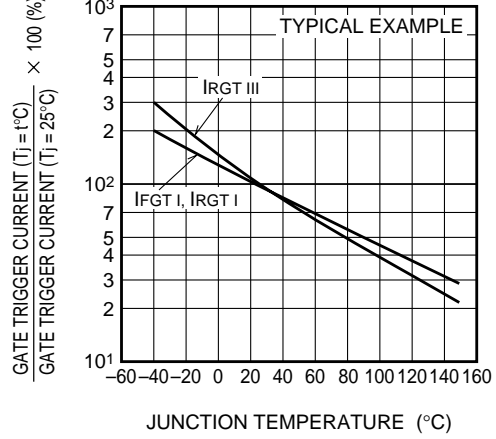

**GATE TRIGGER VOLTAGE VS. JUNCTION TEMPERATURE**

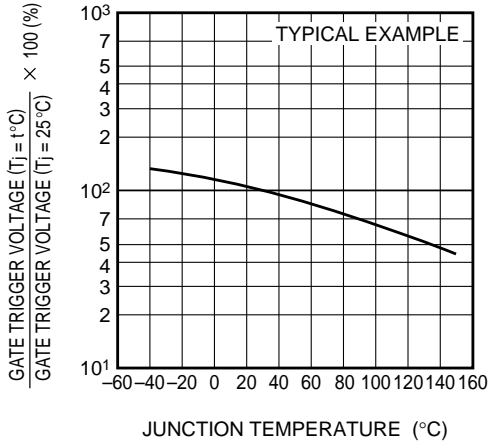

**MAXIMUM TRANSIENT THERMAL IMPEDANCE CHARACTERISTICS (JUNCTION TO CASE)**

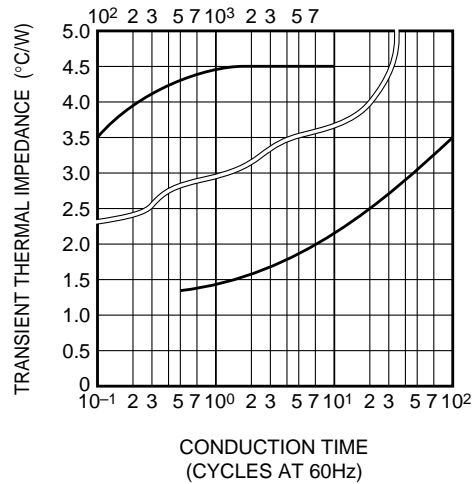

**MAXIMUM ON-STATE POWER DISSIPATION**

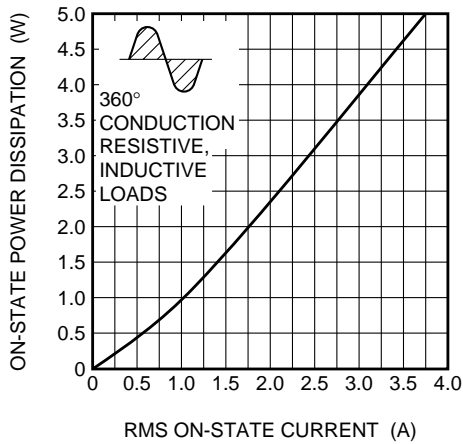

**ALLOWABLE CASE TEMPERATURE VS. RMS ON-STATE CURRENT**

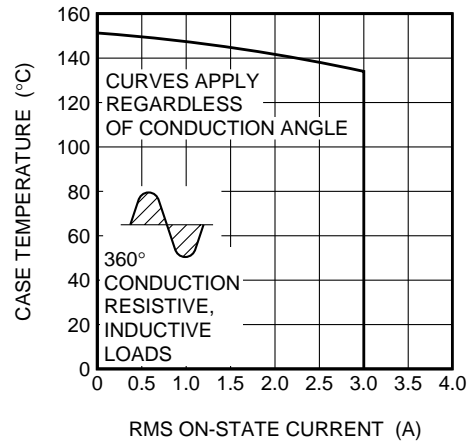



**BCR3PM**

The product guaranteed maximum junction temperature 150°C (See warning.)

**LOW POWER USE**  
**INSULATED TYPE, PLANAR PASSIVATION TYPE**

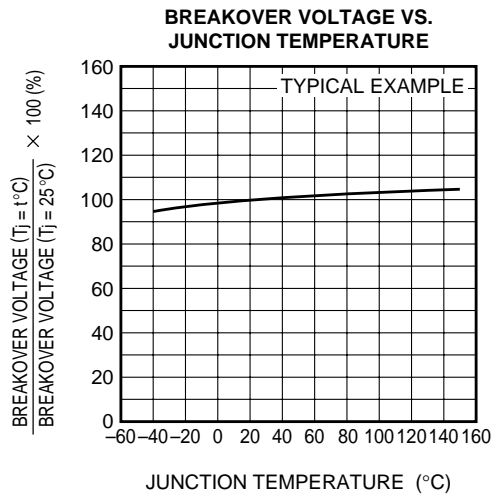
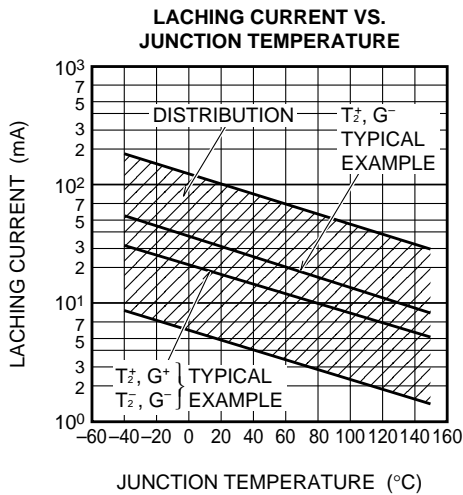
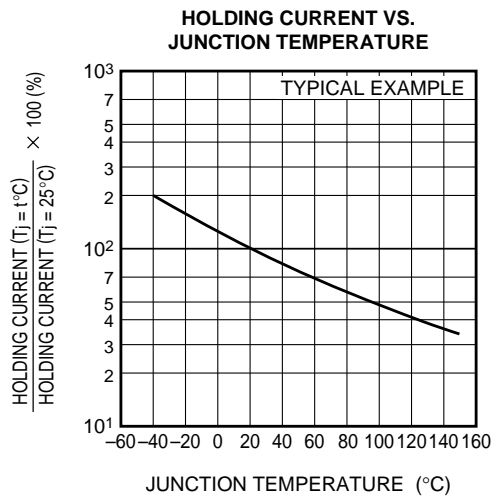
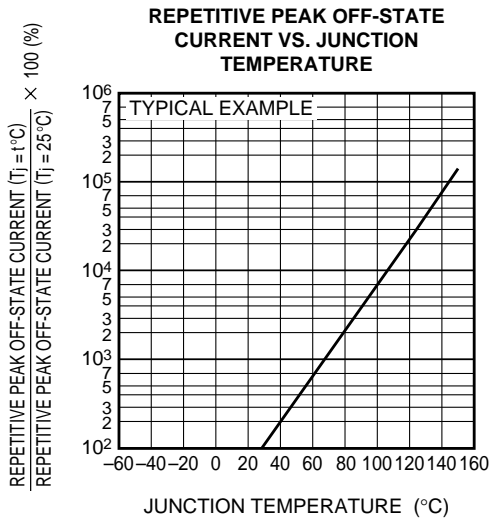
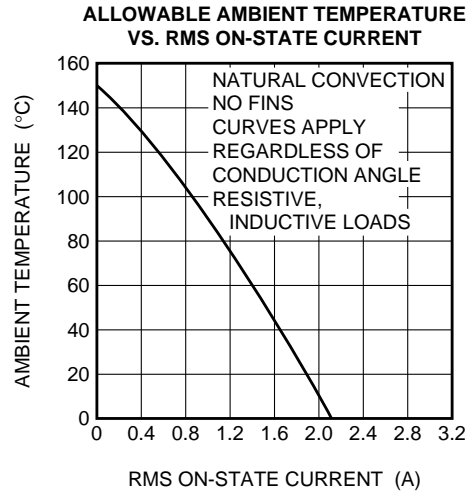
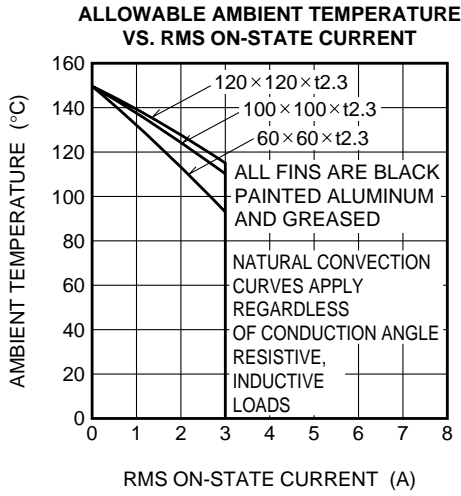

**BCR3PM**

The product guaranteed maximum junction temperature 150°C (See warning.)

**LOW POWER USE**  
**INSULATED TYPE, PLANAR PASSIVATION TYPE**

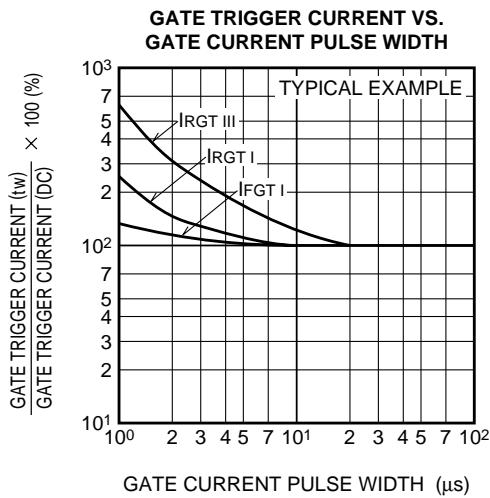
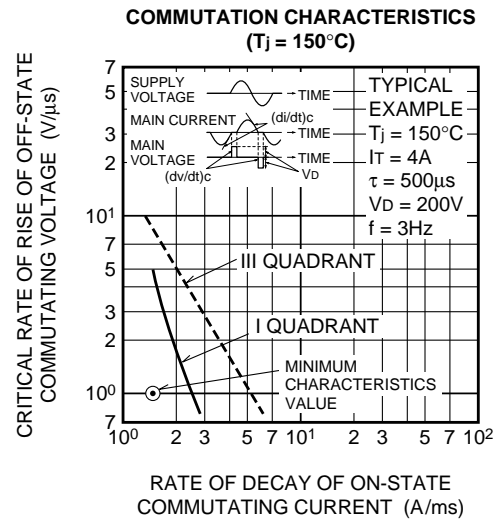
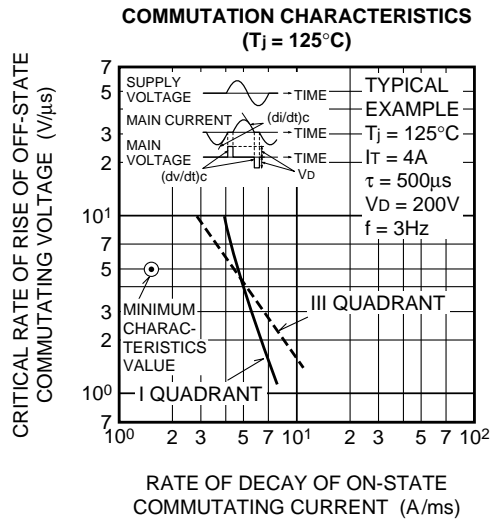
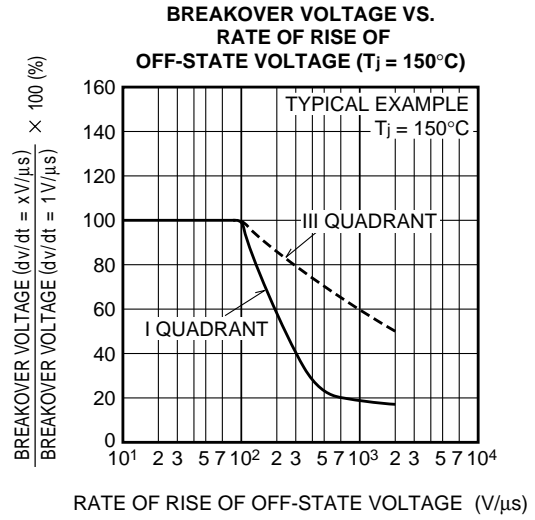
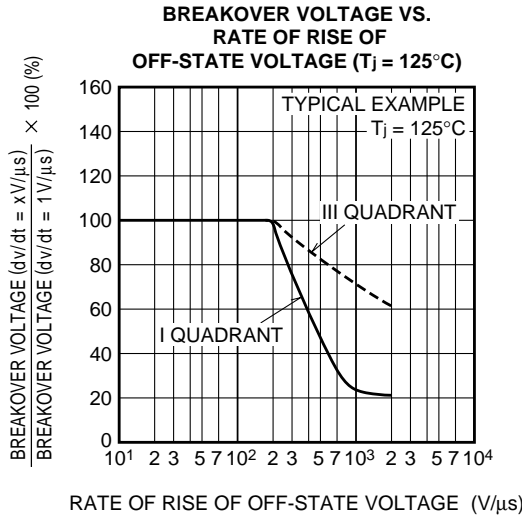

# BCR3PM

The product guaranteed maximum junction temperature 150°C (See warning.)

LOW POWER USE  
INSULATED TYPE, PLANAR PASSIVATION TYPE

### GATE TRIGGER CHARACTERISTICS TEST CIRCUITS

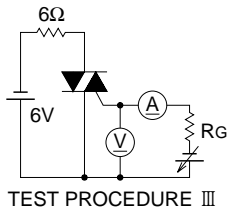
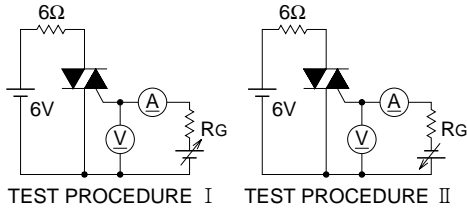

### RECOMMENDED CIRCUIT VALUES AROUND THE TRIAC

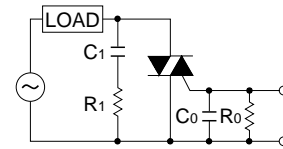

$C_1 = 0.1\text{--}0.47\mu\text{F}$        $C_0 = 0.1\mu\text{F}$   
 $R_1 = 47\text{--}100\Omega$        $R_0 = 100\Omega$