

THESE DRAWINGS ARE THE PROPERTY OF QUALTEK ELECTRONICS AND NOT TO BE REPRODUCED FOR OR COMMUNICATED TO A THIRD PARTY WITHOUT THE EXPRESS WRITTEN PERMISSION OF AN OFFICER OF QUALTEK ELECTRONICS.

REVISION			
REV.	DESCRIPTION	DATE	APPROVED

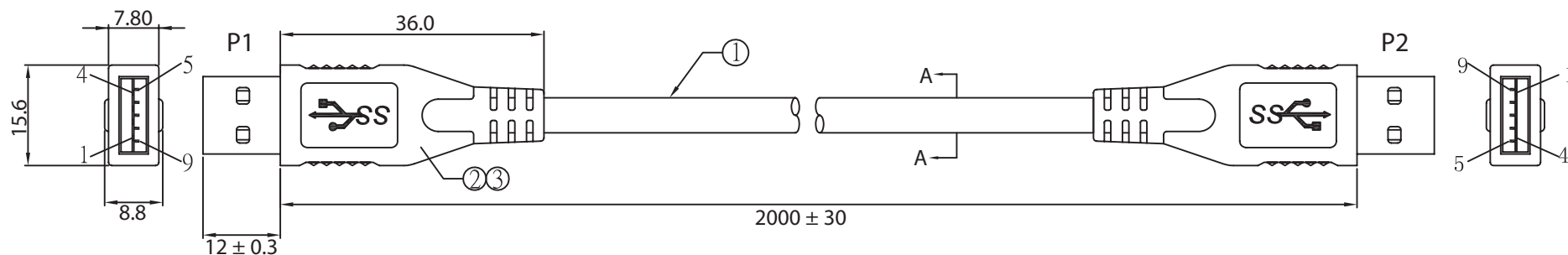

WIRING:

	P1	COLOR	P2
VBUS	1	RED	1 VBUS
D-	2	WHITE	2 D-
D+	3	GREEN	3 D+
GND	4	BLACK	4 GND
StdA_SSRX-	5	BLUE	8 StdA_SSTX-
StdA_SSRX+	6	YELLOW	9 StdA_SSTX+
GND_DRAIN	7	DRAIN	7 GND_DRAIN
StdA_SSTX-	8	PURPLE	5 StdA_SSRX-
StdA_SSTX+	9	ORANGE	6 StdA_SSRX+
SHIELD		BRAID	SHIELD

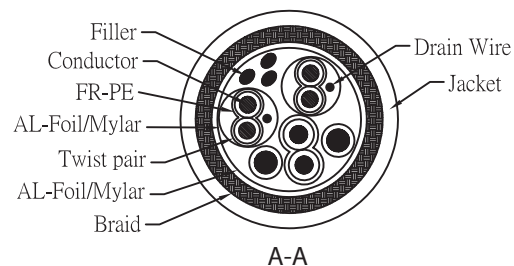
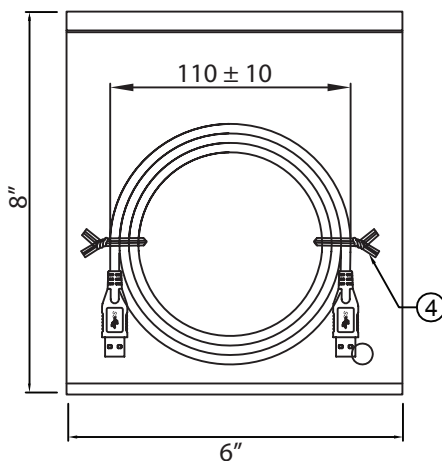

CONTROLLED

No.	PARTS NAME	SPECIFICATION STANDARD	QTY	REMARKS
①	CABLE	UL 20276 O.D. 5.5mm COLOR: BLACK	1	
②	USB3.0 A M 9PIN GOLD PLATED	30U" SHELL NICKEL PLATED INSULATOR BLUE	2	
③	OUTER JACKET	PVC 45Pa BLACK	20	g
④	CABLE TIE	L=13cm COLOR: BLACK	2	

NOTES:

- CABLE: UL20276
(1Px30AWG+D+AL+MY)x2C+1Px30AWG+2Cx24AWG+AL+B
OUTER JACKET: BLACK, O.D.: 5.5mm
- CONNECTORS: USB 3.0 A MALE TO USB 3.0 A MALE
- HOOD: MOLDED TYPE, COLOR: BLACK
- PACKING: 1PC/POLYBAG
- RoHS COMPLIANT

Dim range (mm)	Tolerance +/- (mm)	Qualtek Electronics Corp. WCI DIVISION		
		Part Number: 3023013-02M		RoHS Compliant
0-1	0.15	Description: USB 3.0 A/M - USB 3.0 A/M		
1-6	0.20	UNIT: mm		
6-18	0.30			
18-50	0.50			
50-120	0.70	Drawn / Date	Checked / Date	Approved / Date
120-250	0.90	R.Nuti 06-25-10	06-25-10	LY / 06-25-10
250-500	1.20			