

■ PIN CONFIGURATION

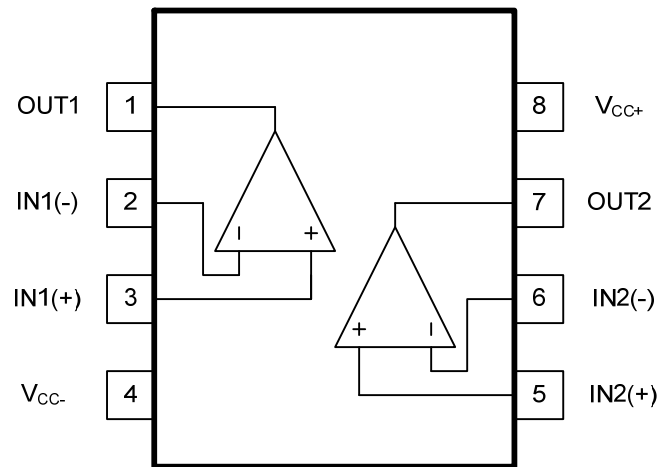

■ TEST CIRCUIT

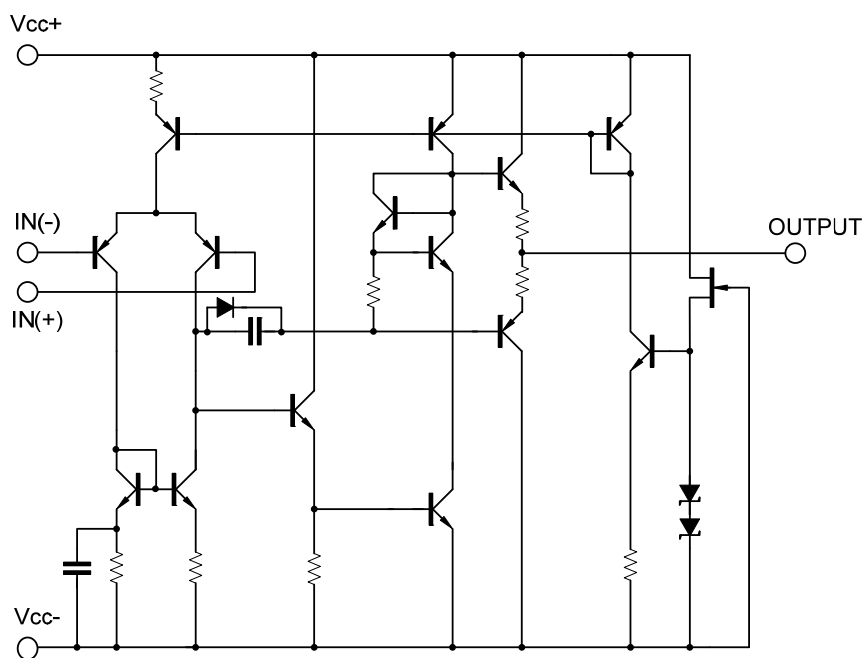

■ ABSOLUTE MAXIMUM RATINGS (Ta=25°C)

PARAMETER		SYMBOL	RATINGS	UNIT
Supply Voltage		V ⁺ /V ⁻	±18	V
Input Voltage		V _{IN}	±15	V
Differential Input Voltage		V _{I(DIFF)}	±30	V
Output Current		I _{OUT}	±50	mA
Power Dissipation	SOP-8	P _D	300	mW
	DIP-8		800	
	TSSOP-8		250	
	MSOP-8		250	
Junction Temperature		T _J	+125	°C
Operating Temperature		T _{OPR}	-40~+85	°C
Storage Temperature		T _{STG}	-40~+125	°C

Note Absolute maximum ratings are those values beyond which the device could be permanently damaged. Absolute maximum ratings are stress ratings only and functional device operation is not implied.

■ ELECTRICAL CHARACTERISTICS (V⁺ /V⁻=±15V, Ta=25°C)

PARAMETER	SYMBOL	TEST CONDITION	MIN	TYP	MAX	UNIT
Input Offset Voltage	V _{I(OFF)}	R _S ≅ 10kΩ	-	0.5	3	mV
Input Offset Current	I _{I(OFF)}		-	5	200	nA
Input Bias Current	I _{I(BIAS)}		-	100	500	nA
Large Signal Voltage Gain	G _V	V _{OUT} =±10V, R _L ≅ 2kΩ	90	110	-	dB
Output Voltage Swing	V _{OM}	R _L ≅ 2kΩ	±12	±13.5	-	V
Input Common Mode Voltage	V _{I(CM)}		±12	±13.5	-	V
Common Mode Rejection Ratio	RR	R _S ≅ 10kΩ	80	110	-	dB
Supply Voltage Rejection Ratio	SVR	R _S ≅ 10kΩ	80	110	-	dB
Operating Current	I _{CC}		-	6	9	mA
Slew Rate	SR	R _L ≅ 2kΩ	-	5	-	V/μs
Gain bandwidth Product	GB	f=10KHz	-	15	-	MHz
Total Harmonic Distortion	THD	G _v =20dB, V _{OUT} =5V, R _L =2kΩ, f=1KHz	-	0.0005	-	%
Input Noise Voltage	e _N	RIAA R _S =2.2 kΩ, 30kHzLPF	-	0.8	-	μVrms

■ TYPICAL CHARACTERISTICS

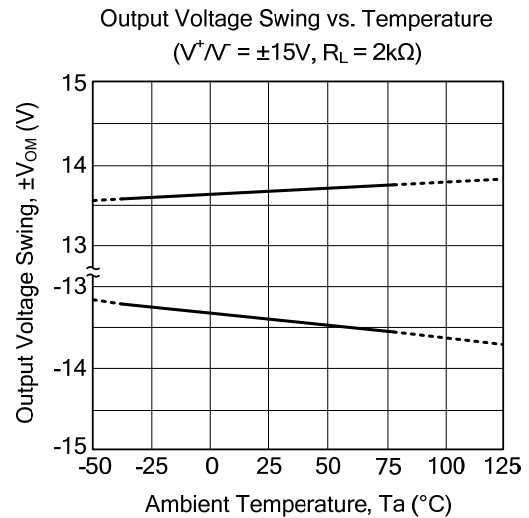
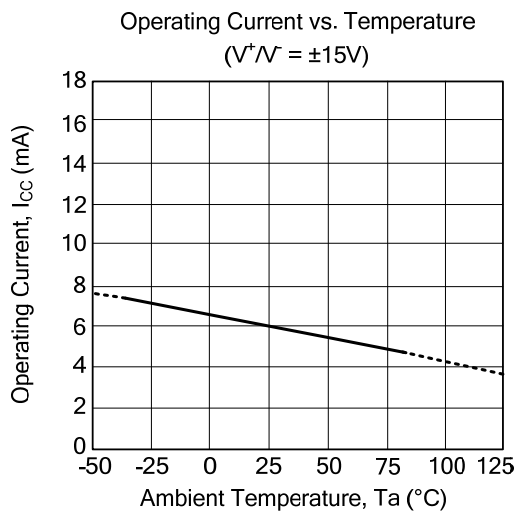
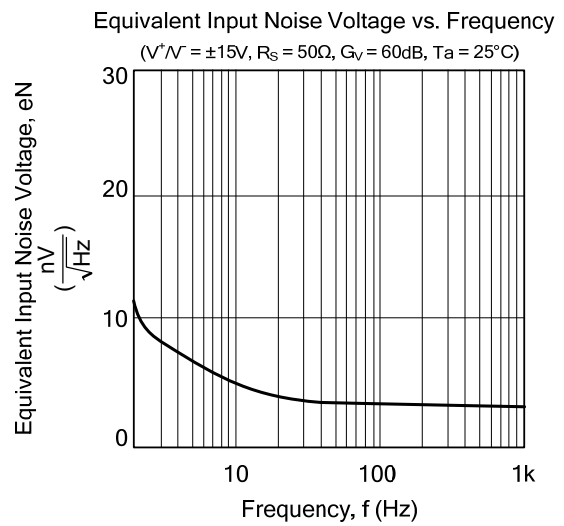
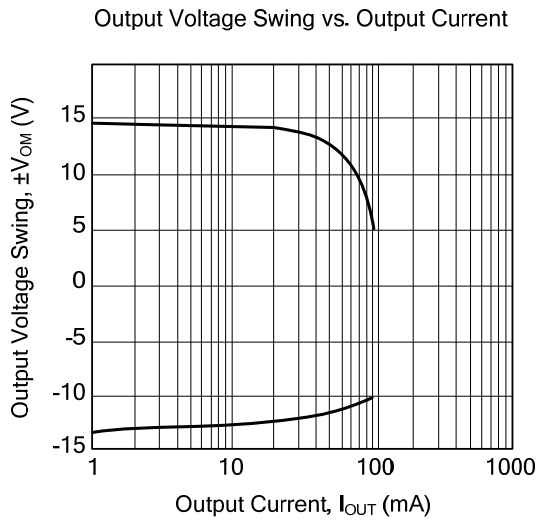
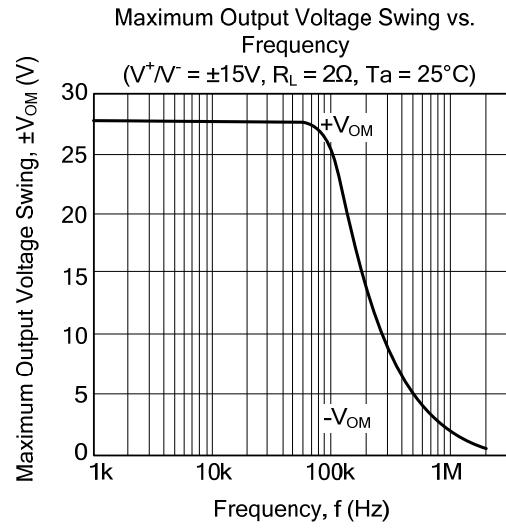
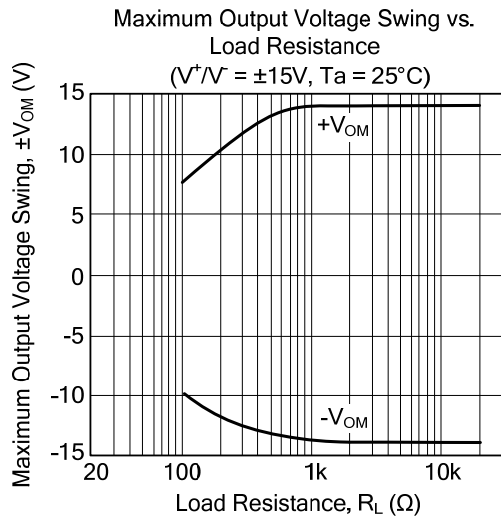

TYPICAL CHARACTERISTICS(Cont.)

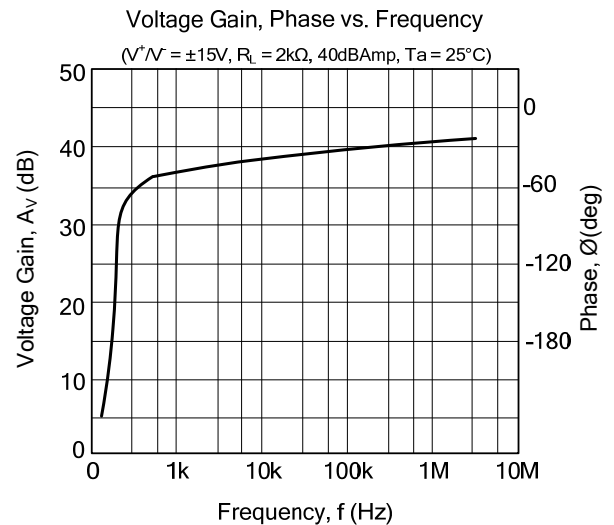
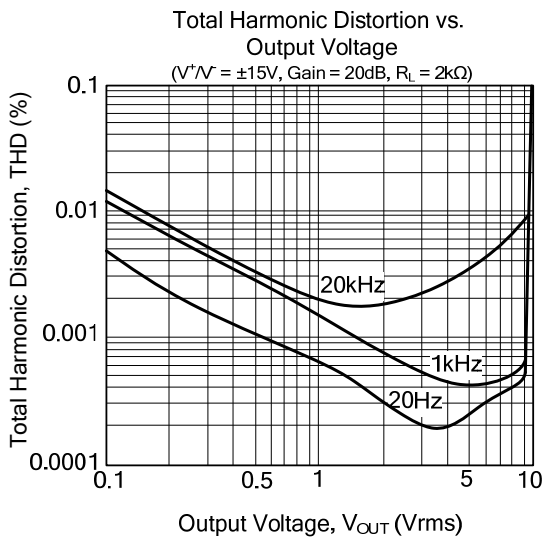
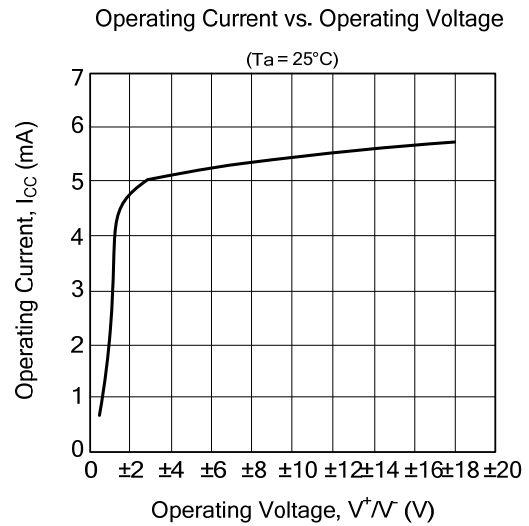
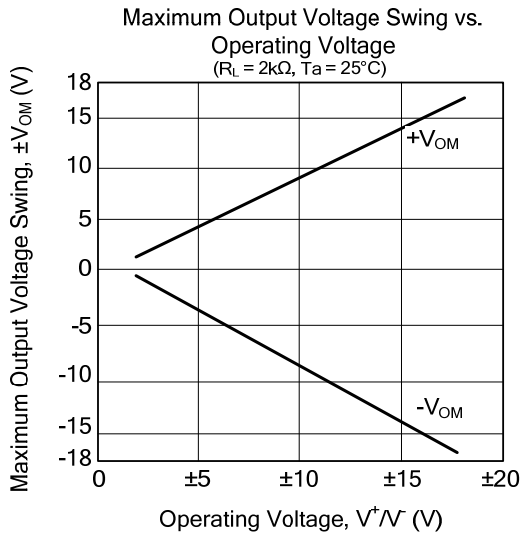
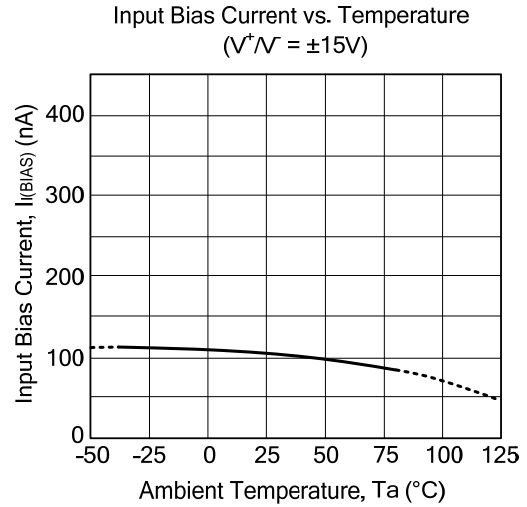
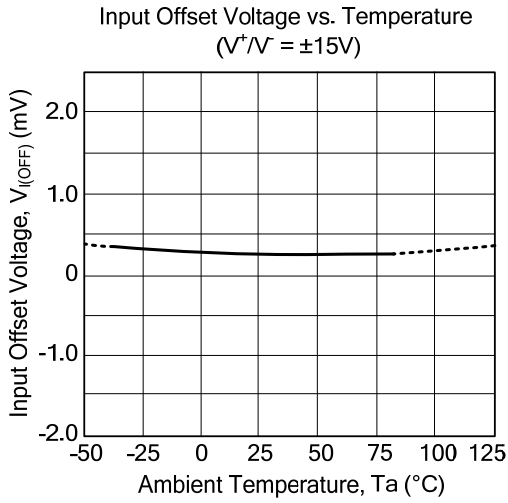

UTC assumes no responsibility for equipment failures that result from using products at values that exceed, even momentarily, rated values (such as maximum ratings, operating condition ranges, or other parameters) listed in products specifications of any and all UTC products described or contained herein. UTC products are not designed for use in life support appliances, devices or systems where malfunction of these products can be reasonably expected to result in personal injury. Reproduction in whole or in part is prohibited without the prior written consent of the copyright owner. The information presented in this document does not form part of any quotation or contract, is believed to be accurate and reliable and may be changed without notice.