

2.0-18.0 GHz GaAs MMIC Low Noise Amplifier



May 2006 - Rev 01-May-06

CMM1110

Features

- ✕ Self Bias Architecture
- ✕ 16.0 dB Small Signal Gain
- ✕ 2.5 dB Noise Figure
- ✕ +13.0 dBm P1dB Compression Point
- ✕ 100% Visual Inspection to MIL-STD-883 Method 2010

Chip Device Layout

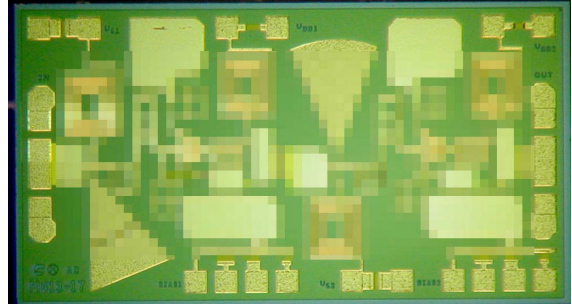

General Description

Mimix Broadband's two stage 2.0-18.0 GHz GaAs MMIC low noise amplifier has a small signal gain of 16.0 dB with a noise figure of 2.5 dB across the band. This MMIC uses Mimix Broadband's 0.3 μm GaAs PHEMT device model technology, and is based upon optical beam lithography to ensure high repeatability and uniformity. The chip has surface passivation to protect and provide a rugged part with backside via holes and gold metallization to allow either a conductive epoxy or eutectic solder die attach process. This device is well suited for fiber optic, microwave radio, military, space, telecom infrastructure, test instrumentation and VSAT applications.

Absolute Maximum Ratings

Supply Voltage (Vd)	+9.0 VDC
Supply Current (Id)	110 mA
Input Power (Pin)	+20 dBm
Storage Temperature (Tstg)	-65 to +165 °C
Operating Temperature (Ta)	-55 to MTTF Table ¹
Channel Temperature (Tch)	MTTF Table ¹

(1) Channel temperature affects a device's MTTF. It is recommended to keep channel temperature as low as possible for maximum life.

Electrical Characteristics (Ambient Temperature T = 25 °C)

Parameter	Units	Min.	Typ.	Max.
Frequency Range (f)	GHz	2.0	-	18.0
Input Return Loss (S11)	dB	-	9.0	-
Output Return Loss (S22)	dB	-	10.0	-
Small Signal Gain (S21)	dB	-	16.0	-
Gain Flatness ($\Delta S21$)	dB	-	+/-1.0	-
Reverse Isolation (S12)	dB	-	30.0	-
Noise Figure (NF)	dB	-	2.5	-
Output Power for 1 dB Compression (P1dB)	dBm	-	+13.0	-
Output Second Order Intercept Point (OIP2)	dBm	-	+31.0	-
Output Third Order Intercept Point (OIP3)	dBm	-	+22.0	-
Drain Bias Voltage (Vd1,2)	VDC	-	+8.0	+8.5
Supply Current (Id) (Vd1,2=8.0V)	mA	-	70	90

100% on-wafer DC testing and 100% RF wafer qualification. Wafer qualification includes sample testing from each quadrant with an 80% pass rate required.

2.0-18.0 GHz GaAs MMIC Low Noise Amplifier



May 2006 - Rev 01-May-06

CMM1110

Low Noise Amplifier Measurements

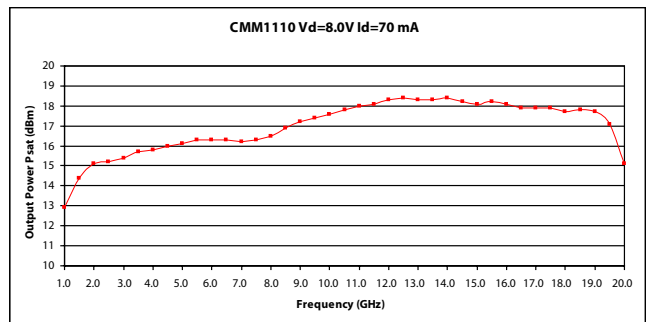
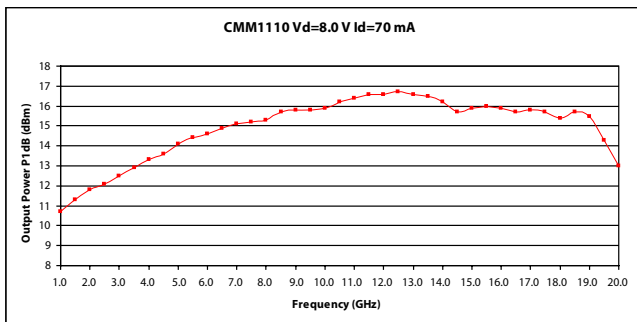
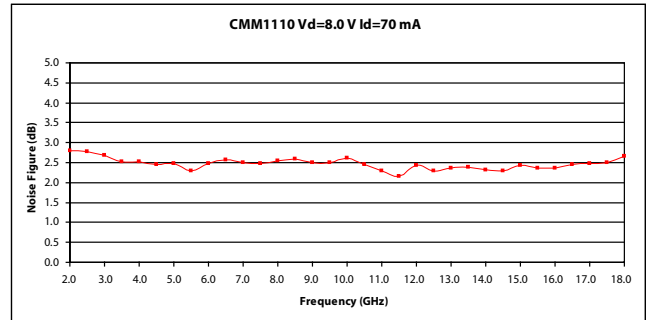
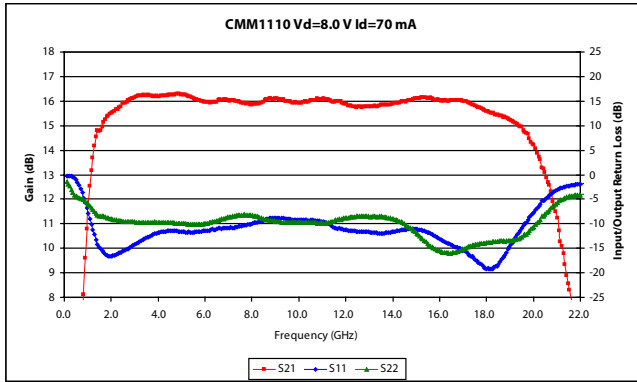

2.0-18.0 GHz GaAs MMIC Low Noise Amplifier



May 2006 - Rev 01-May-06

CMM1110

Low Noise Amplifier Measurements (cont.)

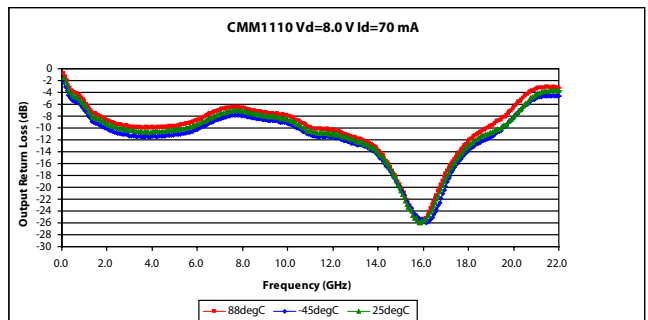
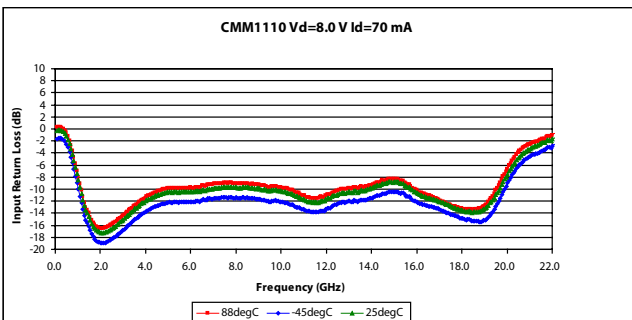
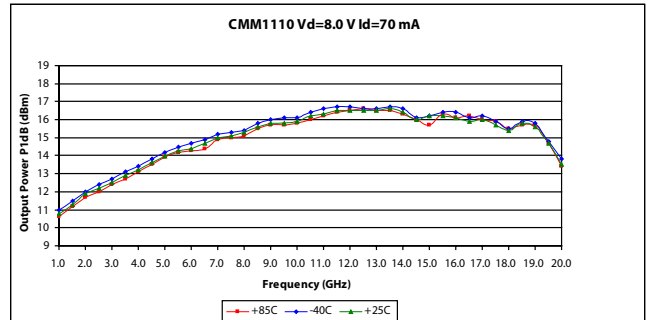
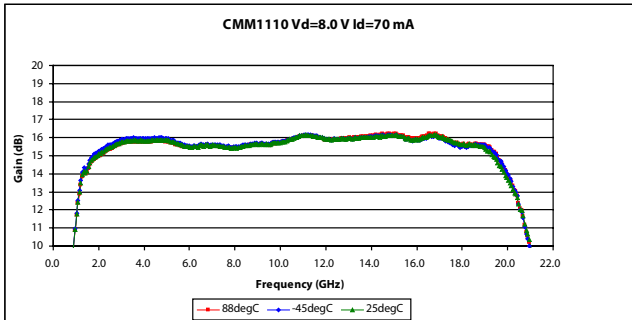

2.0-18.0 GHz GaAs MMIC Low Noise Amplifier



May 2006 - Rev 01-May-06

CMM1110

S-Parameters

Typical S-Parameter Data for CMM1110

Vd=8.0 V Id=70 m A

Frequency (GHz)	S11 (Mag)	S11 (Ang)	S21 (Mag)	S21 (Ang)	S12 (Mag)	S12 (Ang)	S22 (Mag)	S22 (Ang)
0.1	0.997	-17.15	0.001	-114.78	0.000	-2.60	0.901	-25.83
0.5	0.906	-90.42	0.103	36.33	0.003	-145.29	0.569	-66.48
1.0	0.492	102.37	6.952	-179.41	0.005	113.10	0.325	-145.18
2.0	0.145	-47.14	6.861	28.61	0.016	49.95	0.260	-167.45
3.0	0.199	-63.22	6.453	-32.19	0.018	17.23	0.268	168.55
4.0	0.270	-85.42	6.167	-76.77	0.018	-3.67	0.298	147.47
5.0	0.317	-105.34	5.928	-114.26	0.019	-19.66	0.331	127.77
6.0	0.342	-122.00	5.771	-147.92	0.019	-33.14	0.364	109.00
7.0	0.349	-135.78	5.690	-179.65	0.020	-45.25	0.391	90.67
8.0	0.345	-147.36	5.703	149.56	0.020	-56.83	0.405	73.00
9.0	0.332	-156.91	5.739	118.77	0.021	-67.52	0.404	55.71
10.0	0.319	-164.69	5.788	87.98	0.023	-80.40	0.381	39.29
11.0	0.304	-172.07	5.798	56.72	0.024	-92.40	0.338	25.05
12.0	0.289	-179.76	5.777	25.61	0.025	-105.35	0.282	14.08
13.0	0.273	170.53	5.757	-4.90	0.027	-118.26	0.223	8.05
14.0	0.258	157.12	5.820	-36.22	0.027	-131.84	0.170	14.22
15.0	0.225	134.24	5.923	-68.90	0.030	-144.59	0.170	28.25
16.0	0.181	94.45	6.006	-103.58	0.033	-158.59	0.213	33.40
17.0	0.162	40.64	6.097	-141.30	0.038	-176.87	0.246	29.74
18.0	0.217	-2.51	5.883	176.61	0.041	160.70	0.275	25.57
19.0	0.321	-25.79	5.293	132.20	0.043	136.30	0.313	23.02
20.0	0.510	-41.55	4.307	83.26	0.043	106.92	0.405	14.73
21.0	0.746	-66.30	2.832	33.61	0.034	72.39	0.478	-6.57
22.0	0.873	-90.28	1.562	-6.84	0.022	47.32	0.461	-29.63
23.0	0.905	-108.19	0.827	-37.04	0.014	27.92	0.405	-46.68
24.0	0.911	-121.78	0.450	-60.61	0.008	24.21	0.332	-62.86
25.0	0.898	-132.62	0.250	-78.36	0.004	39.39	0.277	-77.72
26.0	0.860	-138.73	0.149	-90.32	0.006	81.72	0.215	-91.15
27.0	0.896	-144.55	0.097	-103.13	0.007	51.61	0.174	-108.96
28.0	0.910	-151.12	0.066	-123.11	0.005	69.19	0.130	-139.57
29.0	0.912	-156.95	0.040	-138.03	0.004	59.81	0.102	171.38
30.0	0.921	-162.26	0.022	-155.11	0.005	72.46	0.098	104.62

2.0-18.0 GHz GaAs MMIC Low Noise Amplifier

May 2006 - Rev 01-May-06

CMM1110

Mechanical Drawing

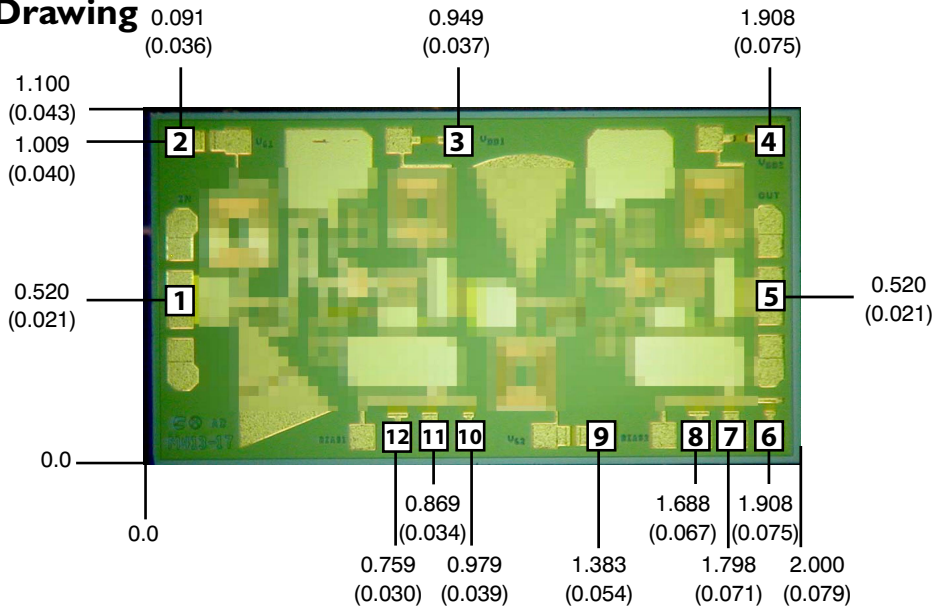

(Note: Engineering designator is M420)

Units: millimeters (inches) Bond pad dimensions are shown to center of bond pad.
 Thickness: 0.110 +/- 0.010 (0.0043 +/- 0.0004), Backside is ground, Bond Pad/Backside Metallization: Gold
 All DC Bond Pads are 0.080 x 0.080 (0.003 x 0.003). All RF Bond Pads are 0.180 x 0.080 (0.007 x 0.003).
 Bond pad centers are approximately 0.109 (0.004) from the edge of the chip.
 Dicing tolerance: +/- 0.005 (+/- 0.0002). Approximate weight: 1.364 mg

Bond Pad #1 (RF In)	Bond Pad #4 (Vd2)	Bond Pad #7 (Rs2-20.0Ω)	Bond Pad #10 (Rs1-32Ω)
Bond Pad #2 (Vg1)	Bond Pad #5 (RF Out)	Bond Pad #8 (Rs2-15Ω)	Bond Pad #11 (Rs1-20Ω)
Bond Pad #3 (Vd1)	Bond Pad #6 (Rs2-32Ω)	Bond Pad #9 (Vg2)	Bond Pad #12 (Rs1-15Ω)

Bias Arrangement

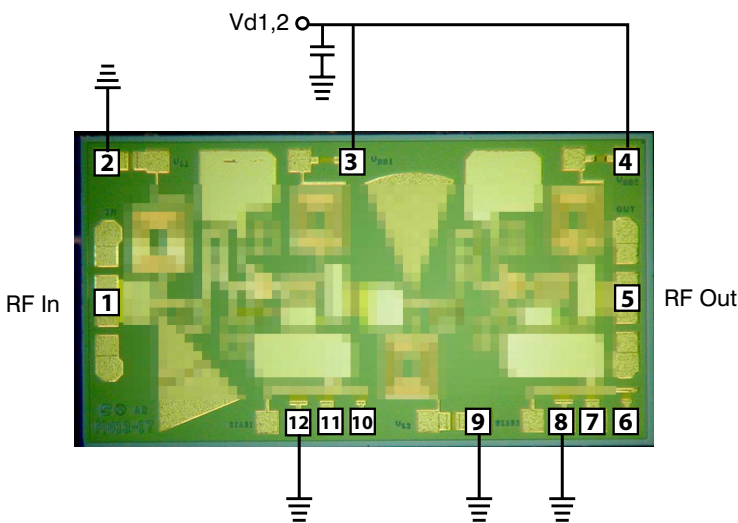

Bypass Capacitors - See App Note [2]

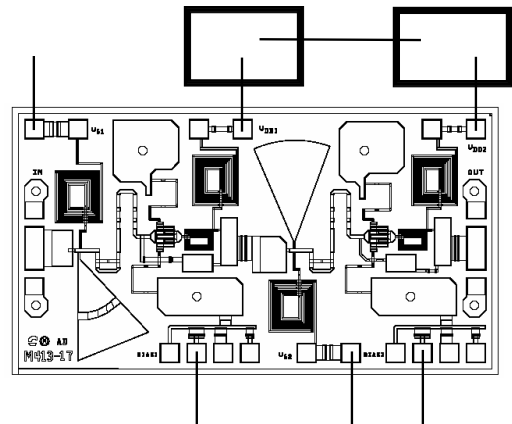

2.0-18.0 GHz GaAs MMIC Low Noise Amplifier



May 2006 - Rev 01-May-06

CMM1110

App Note [1] Biasing - As shown in the bonding diagram, this device operates using a self-biased architecture and only requires one drain bias. Bias is nominally $V_{d1,2}=8V$, $I_{TOTAL}=70mA$. Additionally there are six total source resistors on chip. The three resistors on the input stage are 15, 20 and 32 Ohms. The three resistors on the output stage are 15, 20 and 32 Ohms. One of these must be bonded to ground for each amplifier stage to achieve performance as shown. Bonding to one of the other resistors or any or all in parallel may allow additional performance adjustment.

App Note [2] Bias Arrangement - Each DC pad (V_d) needs to have DC bypass capacitance (~100-200 pF) as close to the device as possible. Additional DC bypass capacitance (~0.01 uF) is also recommended.

MTTF Table (TBD) (Thermal Resistance (R_{th}) is 60.0°C/W)

These numbers were calculated based on accelerated life test information and thermal model analysis received from the fabricating foundry.

Backplate Temperature	Channel Temperature	R_{th}	MTTF Hours	FITs
55 deg Celsius	deg Celsius	C/W	E+	E+
75 deg Celsius	deg Celsius	C/W	E+	E+
95 deg Celsius	deg Celsius	C/W	E+	E+

Bias Conditions: $V_{d1,2}=8.0V$, $I_{TOTAL}=70 mA$

Device Schematic

2.0-18.0 GHz GaAs MMIC Low Noise Amplifier



May 2006 - Rev 01-May-06

CMM1110

Handling and Assembly Information

CAUTION! - Mimix Broadband MMIC Products contain gallium arsenide (GaAs) which can be hazardous to the human body and the environment. For safety, observe the following procedures:

- *Do not ingest.*
- *Do not alter the form of this product into a gas, powder, or liquid through burning, crushing, or chemical processing as these by-products are dangerous to the human body if inhaled, ingested, or swallowed.*
- *Observe government laws and company regulations when discarding this product. This product must be discarded in accordance with methods specified by applicable hazardous waste procedures.*

Life Support Policy - Mimix Broadband's products are not authorized for use as critical components in life support devices or systems without the express written approval of the President and General Counsel of Mimix Broadband. As used herein: (1) Life support devices or systems are devices or systems which, (a) are intended for surgical implant into the body, or (b) support or sustain life, and whose failure to perform when properly used in accordance with instructions for use provided in the labeling, can be reasonably expected to result in a significant injury to the user. (2) A critical component is any component of a life support device or system whose failure to perform can be reasonably expected to cause the failure of the life support device or system, or to affect its safety or effectiveness.

ESD - Gallium Arsenide (GaAs) devices are susceptible to electrostatic and mechanical damage. Die are supplied in antistatic containers, which should be opened in cleanroom conditions at an appropriately grounded antistatic workstation. Devices need careful handling using correctly designed collets, vacuum pickups or, with care, sharp tweezers.

Die Attachment - GaAs Products from Mimix Broadband are 0.076 mm (0.003") thick and have vias through to the backside to enable grounding to the circuit. Microstrip substrates should be brought as close to the die as possible. The mounting surface should be clean and flat. If using conductive epoxy, recommended epoxy is Tanaka TS3332LD cured in a nitrogen atmosphere per manufacturer's cure schedule. Apply epoxy sparingly to avoid getting any on to the top surface of the die. An epoxy fillet should be visible around the total die periphery. If eutectic mounting is preferred, then a fluxless gold-tin (AuSn) preform, approximately 0.001² thick, placed between the die and the attachment surface should be used. A die bonder that utilizes a heated collet and provides scrubbing action to ensure total wetting to prevent void formation in a nitrogen atmosphere is recommended. The gold-tin eutectic (80% Au 20% Sn) has a melting point of approximately 280° C (Note: Gold Germanium should be avoided). The work station temperature should be 310°C +/- 10°C. Exposure to these extreme temperatures should be kept to minimum. The collet should be heated, and the die pre-heated to avoid excessive thermal shock. Avoidance of air bridges and force impact are critical during placement.

Wire Bonding - Windows in the surface passivation above the bond pads are provided to allow wire bonding to the die's gold bond pads. The recommended wire bonding procedure uses 0.076 mm x 0.013 mm (0.003" x 0.0005") 99.99% pure gold ribbon with 0.5-2% elongation to minimize RF port bond inductance. Gold 0.025 mm (0.001") diameter wedge or ball bonds are acceptable for DC Bias connections. Aluminum wire should be avoided. Thermo-compression bonding is recommended though thermosonic bonding may be used providing the ultrasonic content of the bond is minimized. Bond force, time and ultrasonics are all critical parameters. Bonds should be made from the bond pads on the die to the package or substrate. All bonds should be as short as possible.

Part Number for Ordering	Description
CMM1110-BD	RoHS compliant die packed in gel paks
PB-CMM1110-BD	CMM1110-BD evaluation module

Mimix Broadband, Inc., 10795 Rockley Rd., Houston, Texas 77099
Tel: 281.988.4600 Fax: 281.988.4615 mimixbroadband.com

Page 7 of 7

Characteristic Data and Specifications are subject to change without notice. ©2006 Mimix Broadband, Inc.
Export of this item may require appropriate export licensing from the U.S. Government. In purchasing these parts, U.S. Domestic customers accept their obligation to be compliant with U.S. Export Laws.