

T-29-25

**2SK156**



2037

N-Channel Junction Silicon Field-Effect Transistor

# Capacitor Microphone Impedance Conversion Applications

©540F

**ABSOLUTE MAXIMUM RATINGS/T<sub>a</sub> = 25°C**

|                             |                  |            | unit |
|-----------------------------|------------------|------------|------|
| Gate drain voltage          | V <sub>DGO</sub> | -20        | V    |
| Gate current                | I <sub>G</sub>   | 10         | mA   |
| Allowable power dissipation | P <sub>D</sub>   | 100        | mW   |
| Junction temperature        | T <sub>J</sub>   | 125        | °C   |
| Storage ambient temperature | T <sub>stg</sub> | -40 ~ +125 | °C   |

**ELECTRICAL CHARACTERISTICS/T<sub>a</sub> = 25°C**

|               |                  |   | min | typ | max  | unit |
|---------------|------------------|---|-----|-----|------|------|
| Drain current | I <sub>DSS</sub> | V <sub>DS</sub> = 10 V, V <sub>GS</sub> = 0 | 60* |     | 800* | μA   |

[T<sub>a</sub> = 25°C, V<sub>CC</sub> = 4.5 V, R<sub>D</sub> = 680 Ω, C<sub>in</sub> = 15 pF, in specified test circuit (conforming with application circuit)]

|  |                  |   | min | typ | max  | unit |
|--|------------------|---|-----|-----|------|------|
| Transmission loss                                | G <sub>V</sub>   | V <sub>in</sub> = 10 mV, f = 1 kHz                                |     | -5  |      | dB   |
| Voltage-drop characteristic of transmission loss | ΔG <sub>VV</sub> | V <sub>CC</sub> = 4.5 ~ 1.5 V, f = 1 kHz, V <sub>in</sub> = 10 mV |     |     | -3   | dB   |
| Frequency characteristic of transmission loss    | ΔG <sub>Vf</sub> | f = 1 k ~ 110 Hz, V <sub>in</sub> = 10 mV                         |     |     | -1   | dB   |
| Input impedance                                  | z <sub>in</sub>  | f = 1 kHz   | 20  |     |      | MΩ   |
| Output noise voltage                             | V <sub>NO</sub>  | V <sub>in</sub> = 0, A-curve                                      |     |     | -110 | dB   |

\* The 2SK156 is graded as follows by drain current I<sub>DSS</sub> (unit: μA):

|    |   |     |     |   |     |     |   |     |     |   |     |
|----|---|-----|-----|---|-----|-----|---|-----|-----|---|-----|
| 60 | J | 180 | 150 | K | 300 | 250 | L | 450 | 400 | M | 800 |
|----|---|-----|-----|---|-----|-----|---|-----|-----|---|-----|

**Electrical Connection**

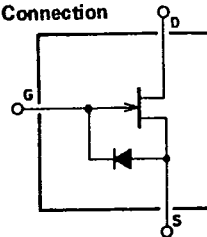

**Case Outline 2037**  
(unit: mm)

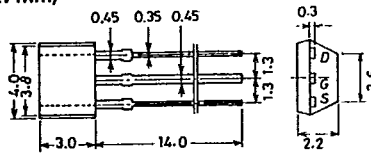

D: Drain  
G: Gate  
S: Source  
SANYO: SP'

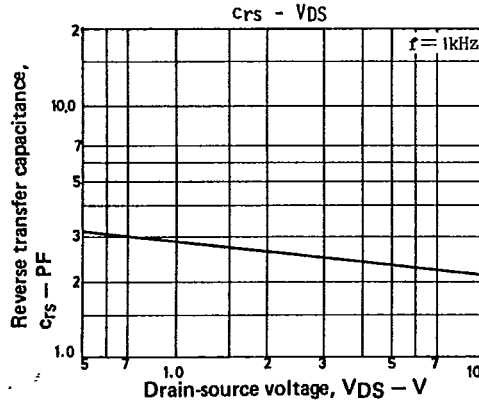
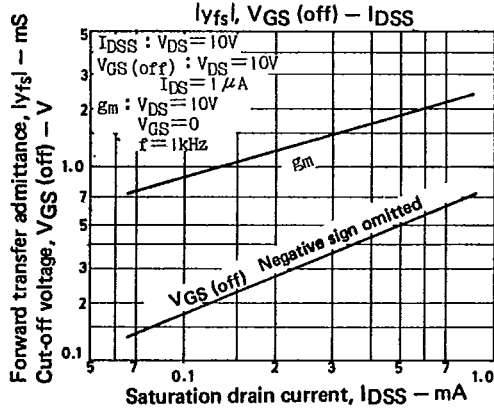
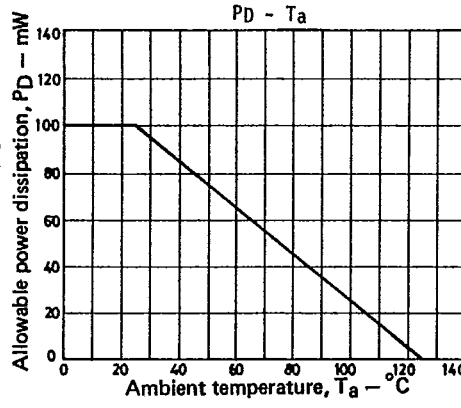
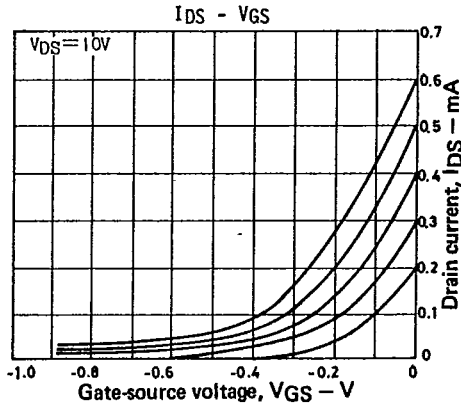
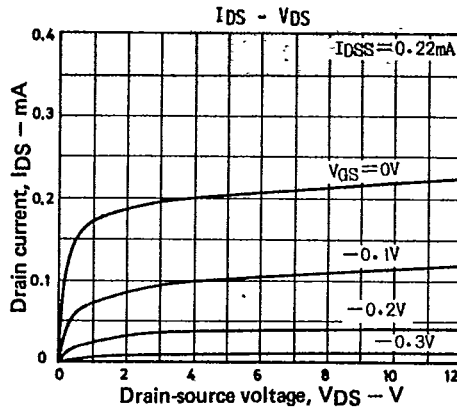
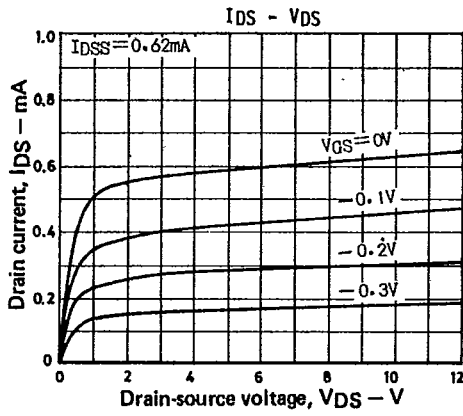

■ Sample application circuit: 2-wire system

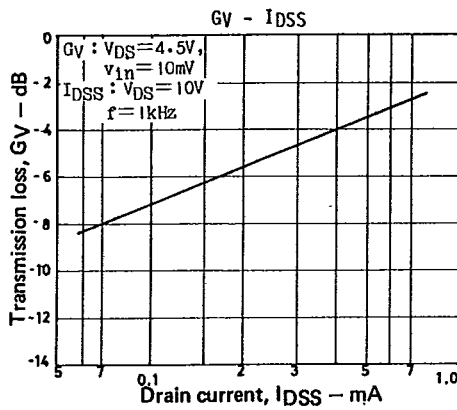
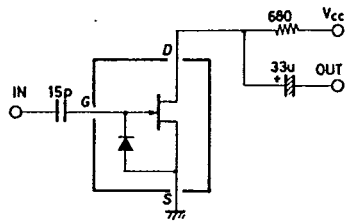

2SK156

(T-29-25)

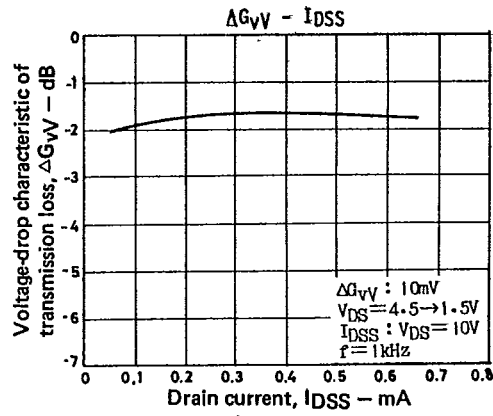
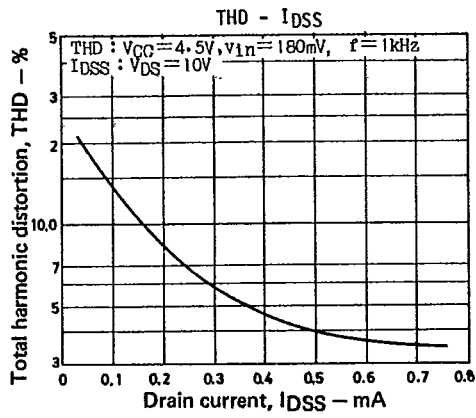

T-91-20

# CASE OUTLINES AND ATTACHMENTS

- All of Sanyo Transistor case outlines are illustrated below.
- All dimensions are in mm, and dimensions which are not followed by min. or max. are represented by typical values.
- No marking is indicated.

Case Outline-[2003A]

unit:mm

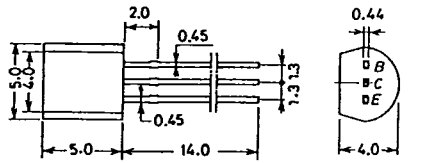

JEDEC: TO-92  
EIAJ: SC-43  
SANYO: NP

B: Base  
C: Collector  
E: Emitter

Case Outline-[2009A]

unit:mm

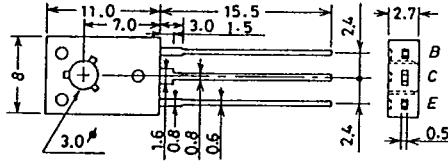

JEDEC: TO-126

B: Base  
C: Collector  
E: Emitter

Case Outline-[2004A]

unit:mm

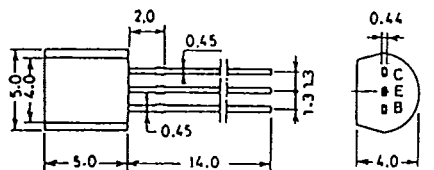

JEDEC: TO-92  
EIAJ: SC-43  
SANYO: NP

C: Collector  
E: Emitter  
B: Base

Case Outline-[2010A]

unit:mm

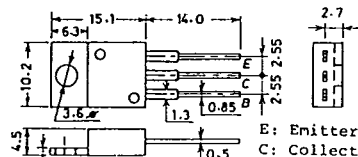

JEDEC: TO-220AB  
EIAJ: SC-46

E: Emitter  
C: Collector  
B: Base

Case Outline-[2005A]

unit:mm

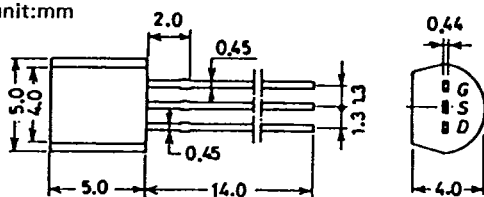

JEDEC: TO-92  
EIAJ: SC-43  
SANYO: NP

G: Gate  
S: Source  
D: Drain

Case Outline-[2012]

unit:mm

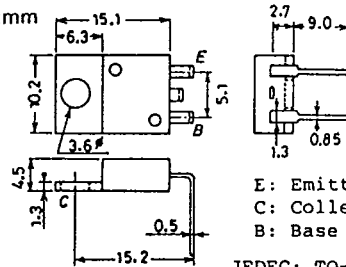

JEDEC: TO-220AA  
EIAJ: SC-45

E: Emitter  
C: Collector  
B: Base

Case Outline-[2006A]

unit:mm

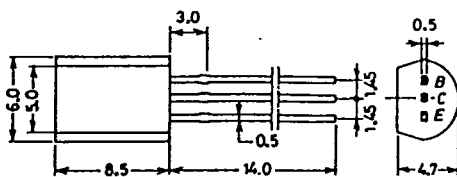

EIAJ: SC-51  
SANYO: MP

B: Base  
C: Collector  
E: Emitter

Case Outline-[2013]

unit:mm

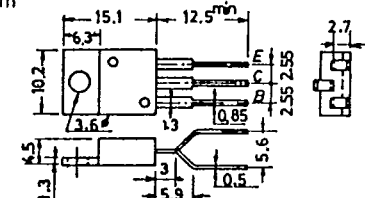

JEDEC TO-220

B: Base  
C: Collector  
E: Emitter

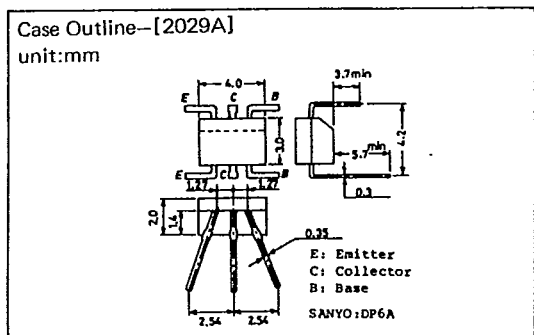
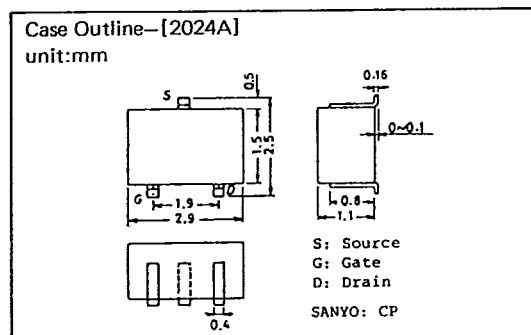
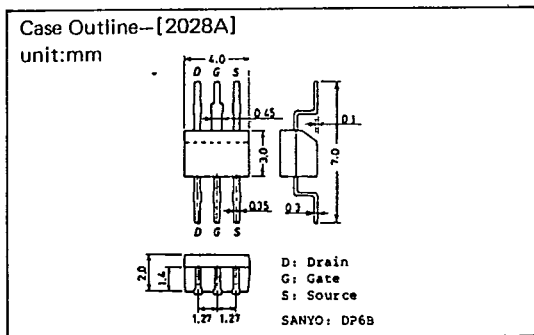
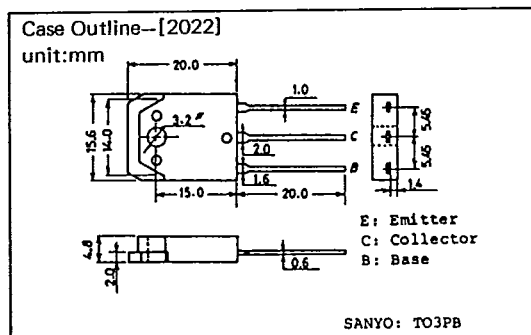
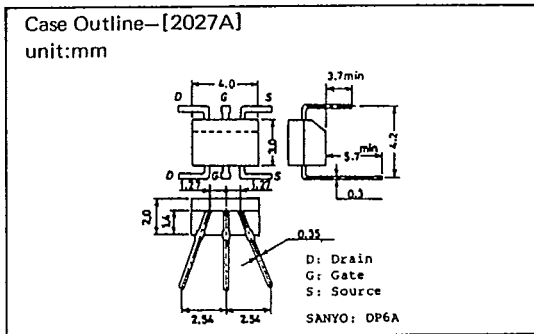
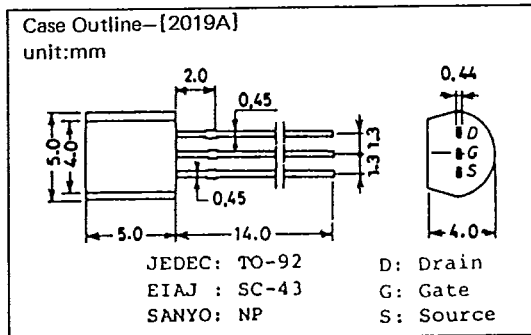
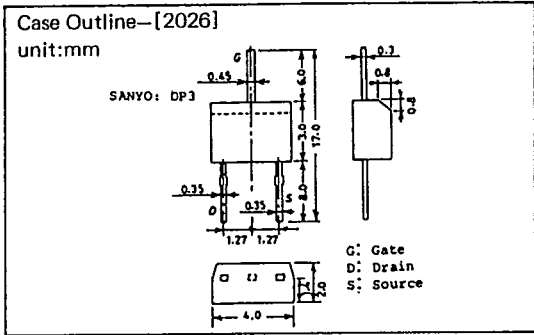
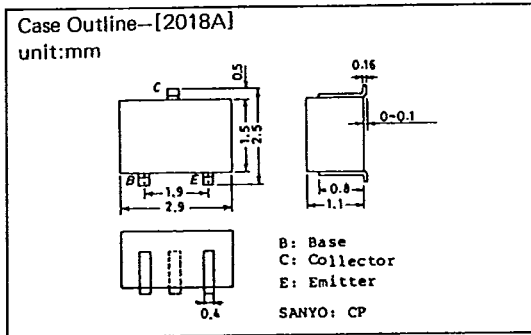
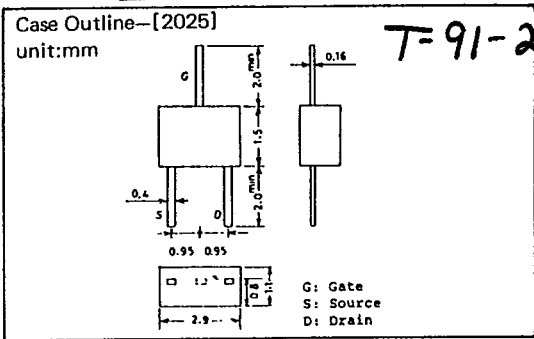
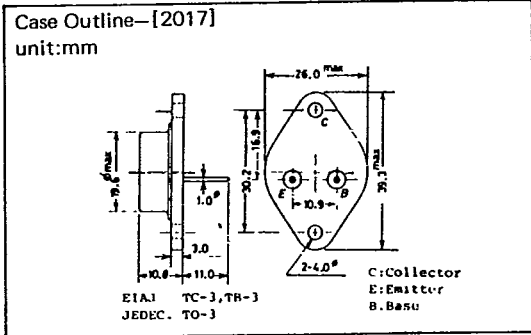



T-91-20

