

FEATURES

- Fully qualified to Class H or K
- Radiation hardened
- -55° to +125°C operation
- 16 to 40 VDC input
- Fully Isolated
- Magnetic feedback
- Fixed frequency, 600 kHz typical
- Topology – Single Ended Forward
- Inhibit function
- Sync function
- Indefinite short circuit protection
- Up to 30 watts output power
- Trim function on single output models
- Up to 81% efficiency

DC/DC CONVERTERS 28 VOLT INPUT

SMTR SERIES 30 WATT



MODELS	
VDC OUTPUT	
SINGLE	DUAL
3.3	±5
5	±12
12	±15
15	

Size (max.): Non-flanged Case: H2 2.125 x 1.125 x 0.400 inches (53.98 x 28.58 x 10.16 mm)

Flanged Case: K3 2.910 x 1.125 x 0.400 inches (73.79 x 28.58 x 10.16 mm)

See Figures 22 through 25 for dimensions.

Weight: Non-flanged 52 grams max., flanged 55 grams max.

Screening: Space prototype, Class H, or Class K (MIL-PRF-38534)

Radiation hardness levels O or R

DESCRIPTION

The SMTR Series™ of 28 volt DC/DC converters offers up to 30 watts of output power from single or dual output configurations. They operate over the full military temperature range of -55°C to +125°C with up to 84% efficiency. SMTR converters are packaged in hermetically sealed metal enclosures, making them ideal for use in military, aerospace and other high reliability applications.

SCREENING AND REPORTS

SMTR converters offer three screening options (Standard, Class H, or Class K) and two levels of radiation hardness (O or R). See Tables 1, 2, and 3 for more information. Detailed reports on product performance are also available and are listed in Table 4.

CONVERTER DESIGN

The SMTR converters are constant frequency, pulse-width modulated switching regulators which use a quasi-square wave, single ended, forward converter design. Tight load regulation is maintained by using a wide bandwidth magnetic feedback and, on single output models, through use of remote sense. On dual output models, the positive output is independently regulated and the negative output is cross regulated through the use of tightly coupled magnetics.

Indefinite short circuit protection and overload protection are provided by a constant current-limit feature. This protective system senses current in the converter's secondary stage and limits it to approximately 115% of the maximum rated output current.

SMTR converters are provided with internal filtering capacitors that help reduce the need for external components in normal operation. For systems that require compliance with MIL-STD-461C's CE03 standard, Interpoint offers filter/transient suppression modules (including the FMC-461, FMD-461 and FM-704A series filters) which will result in compliance. For the lowest noise performance, connection of the case to input common is recommended. The connection can be hard-wired or AC coupled with a small ceramic bypass capacitor.

SYNCHRONIZATION

Synchronizing the converter with the system clock allows the designer to confine switching noise to clock transitions, minimizing interference and reducing the need for filtering. In sync mode, the converter will run at any frequency between 500 kHz and 675 kHz. The sync control operates with a quasi-TTL signal at any duty cycle between 40% and 60%. The sync pin should be connected to input common pin when not in use.

WIDE VOLTAGE RANGE

SMTR converters are designed to provide full power operation over a full 16 to 40 Vdc voltage range. Operation below 16 volts, including MIL-STD-704D emergency power conditions is possible with derated power.

IMPROVED DYNAMIC RESPONSE

The SMTR Series feed-forward compensation system provides excellent dynamic response and noise rejection. Audio rejection is typically 50 dB. The min. to max. step line transient response is typically less than 4%.

INHIBIT FUNCTION

SMTR converters provide an inhibit terminal that can be used to disable internal switching, resulting in no output and very low quiescent input current. The converter is inhibited when a TTL compatible low ($\leq 0.8V$) is applied to the inhibit pin. The unit is enabled when the pin, which is internally connected to a pull-up resistor, is left unconnected or is connected to an open-collector gate. The open circuit output voltage associated with the inhibit pin is 9 to 11 Vdc. In the inhibit mode, a maximum of 8 mA must be sunk from the inhibit pin.

SMTR SERIES 30 WATT

DC/DC CONVERTERS

ABSOLUTE MAXIMUM RATINGS

- Input Voltage**
- 16 to 40 VDC
- Output Power**
- 25 to 30 watts depending on model
- Lead Soldering Temperature (10 sec per pin)**
- 300°C
- Storage Temperature Range (Case)**
- -65°C to +135°C

RECOMMENDED OPERATING CONDITIONS

- Input Voltage Range**
- 16 to 40 VDC continuous
 - 50 V for 50 msec transient
- Case Operating Temperature (Tc)**
- -55°C to +125°C full power
 - -55°C to +135°C absolute
- Derating Output Power/Current**
- Linearly from 100% at 125°C to 0% at 135°C

SYNC AND INHIBIT

- Sync (500 to 675 kHz)**
- Duty cycle 40% min, 60% max
 - Logic low 0.8 V max
 - Logic high 4.5 V min, 5 V max
 - Referenced to input common
 - If not used, connect to input common
- Inhibit TTL Open Collector**
- Logic low (output disabled)
Voltage ≤ 0.8 V
Inhibit pin current 8.0 mA max
 - Referenced to input common
 - Logic high (output enabled)
Open collector

TYPICAL CHARACTERISTICS

- Output Voltage Temperature Coefficient**
- 100 ppm/°C typical single and dual outputs
 - 200 ppm/°C main, 300 ppm/°C aux triple output
- Input to Output Capacitance**
- 50 pF typ (100 pF typ triple outputs)
- Current Limit**
- 115% of full load typical
- Isolation**
- 100 megohm minimum at 500 V
- Audio Rejection**
- 40 dB typ (50 dB typ triple output)
- Conversion Frequency**
- Free run 550 min, 600 typ, 650 max kHz
 - External sync 500 to 675 kHz
- Inhibit Pin Voltage (unit enabled)**
- 9 to 11 V

Electrical Characteristics: 25°C Tc, 28 VDC Vin, 100% load, radiation level O, unless otherwise specified.

SINGLE OUTPUT MODELS		SMTR283R3S			SMTR2805S			SMTR2812S			SMTR2815S			UNITS
PARAMETER	CONDITION	MIN	TYP	MAX	MIN	TYP	MAX	MIN	TYP	MAX	MIN	TYP	MAX	
OUTPUT VOLTAGE		3.27	3.30	3.33	4.95	5.00	5.05	11.88	12.00	12.12	14.85	15.00	15.15	VDC
OUTPUT CURRENT ¹	V _{IN} = 16 to 40 VDC	0	—	5.45	0	—	5.0	0	—	2.5	0	—	2.0	A
OUTPUT POWER ¹	V _{IN} = 16 to 40 VDC	0	—	18	0	—	25	0	—	30	0	—	30	W
OUTPUT RIPPLE VOLTAGE	10 kHz – 2 MHz Tc = -55°C TO +125°C	—	15	40	—	35	40	—	25	40	—	25	40	mV p-p
LINE REGULATION ²	V _{in} = 16 to 40 VDC Tc = -55°C TO +125°C	—	—	20	—	15	50	—	15	50	—	15	50	mV
LOAD REGULATION	NO LOAD TO FULL Tc = -55°C TO +125°C	—	—	20	—	15	50	—	15	50	—	15	50	mV
INPUT VOLTAGE ¹	CONTINUOUS	16	28	40	16	28	40	16	28	40	16	28	40	VDC
NO LOAD TO FULL	TRANSIENT 50 ms	—	—	50	—	—	50	—	—	50	—	—	50	V
INPUT CURRENT ¹	NO LOAD	—	30	75	—	35	75	—	35	75	—	35	75	mA
	FULL LOAD	—	0.94	—	—	1.15	—	—	1.30	—	—	1.25	—	A
	INHIBITED	—	7	8	—	3	8	—	3	8	—	3	8	mA
INPUT RIPPLE CURRENT ³	10 kHz – 10 MHz Tc = -55°C TO +125°C	—	25	50	—	20	50	—	20	50	—	20	50	mA p-p
EFFICIENCY		74	76	—	74	78	—	78	83	—	79	84	—	%
LOAD FAULT ⁴	SHORT CIRCUIT POWER DISSIPATION RECOVERY ^{1, 5}	—	—	10	—	—	10	—	—	10	—	—	10	W
STEP LOAD RESP.	50% – 100% – 50%	—	±125	±250	—	±200	±300	—	±250	±400	—	±350	±500	mV pk
	TRANSIENT RECOVERY ⁵	—	—	200	—	60	200	—	60	200	—	60	200	µs
STEP LINE RESP.	16 – 40 – 16 VDC	—	—	±300	—	±200	±300	—	±400	±500	—	±500	±600	mV pk
	TRANSIENT ⁶ RECOVERY ⁵	—	—	300	—	—	300	—	—	300	—	—	300	µs
START-UP ¹	DELAY	—	1.4	5	—	1.4	5	—	1.4	5	—	1.4	5	ms
	OVERSHOOT FULL LOAD	—	0	50	—	0	50	—	0	120	—	0	150	mV pk
	NO LOAD	—	33	150	—	50	250	—	120	600	—	150	750	mV pk

Notes

1. Tc = -55°C to +125°C
2. Operation is limited below 16V (see Figure 21).
3. Tested with 3300 pF ceramic bypass capacitors connected externally from input common to case and output common to case.
4. Indefinite short circuit protection not guaranteed above 125°C case.
5. Recovery time is measured from application of the transient to point at which Vout is within 1% of final value.
6. Transition time ≥ 10 µs.

DC/DC CONVERTERS

SMTR SERIES 30 WATT

Electrical Characteristics: 25°C Tc, 28 VDC Vin, 100% load, radiation level O, unless otherwise specified.

DUAL OUTPUT MODELS		SMTR2805D			SMTR2812D			SMTR2815D			UNITS	
PARAMETER	CONDITIONS	MIN	TYP	MAX	MIN	TYP	MAX	MIN	TYP	MAX		
OUTPUT VOLTAGE	+V _{OUT}	4.95	5.00	5.05	11.88	12.00	12.12	14.85	15.00	15.15	VDC	
	-V _{OUT}	4.92	5.00	5.08	11.82	12.00	12.18	14.77	15.00	15.23		
OUTPUT CURRENT ^{1, 2}	V _{IN} = 16 TO 40 VDC	0	2.5	4.5	0	1.25	2.25	0	1.0	1.8	A	
OUTPUT POWER ^{1, 2}	V _{IN} = 16 TO 40 VDC	0	—	25	0	—	30	0	—	30	W	
OUTPUT RIPPLE	10 kHz - 2 MHz	—	20	50	—	30	80	—	25	80	mV p-p	
VOLTAGE +/- V _{OUT}	Tc = -55°C TO +125°C	—	40	80	—	40	120	—	40	120		
LINE REGULATION ³	Tc = -55°C	+V _{OUT}	—	10	50	—	10	50	—	10	50	mV
	V _{IN} = 16 TO 40 VDC	TO +125°C	-V _{OUT}	—	50	100	—	50	150	—	50	
LOAD REGULATION	Tc = -55°C	+V _{OUT}	—	5	50	—	15	50	—	15	50	mV
	NO LOAD TO FULL	TO +125°C	-V _{OUT}	—	25	100	—	30	180	—	30	
CROSS REGULATION	SEE NOTE 4	—	7	12	—	4	8.3	—	3	8	%	
EFFECT ON -V _{OUT}	SEE NOTE 5	—	4	6	—	4	6	—	4	6		
INPUT VOLTAGE ¹	CONTINUOUS	16	28	40	16	28	40	16	28	40	VDC	
NO LOAD TO FULL	TRANSIENT 50 ms	0	—	50	0	—	50	0	—	50	V	
INPUT CURRENT	NO LOAD	—	35	75	—	50	75	—	50	75	mA	
	FULL LOAD	—	1.10	—	—	1.34	—	—	1.29	—	A	
	INHIBITED	—	3	8	—	3	8	—	3	8	mA	
INPUT RIPPLE CURRENT ^{1, 6}	10 kHz - 10 MHz	—	15	50	—	20	50	—	20	50	mA p-p	
EFFICIENCY		74	76	—	77	80	—	78	81	—	%	
LOAD FAULT ⁷	POWER DISSIPATION	—	—	10	—	—	10	—	—	10	W	
	SHORT CIRCUIT ¹	—	1.4	5.0	—	1.4	5.0	—	1.4	5.0		
STEP LOAD RESPONSE ± V _{OUT}	50 – 100 – 50% BALANCED	—	—	—	—	—	—	—	—	—	mV pk	
	TRANSIENT	—	±200	±300	—	±150	±300	—	±200	±400		
	RECOVERY ⁸	—	100	200	—	100	200	—	100	200		
STEP LINE RESPONSE ± V _{OUT}	16 – 40 – 16 V _{IN}	—	±200	±400	—	±200	±400	—	±400	±500	mV pk	
	TRANSIENT ⁹	—	—	300	—	—	300	—	—	300		
	RECOVERY ⁸	—	—	300	—	—	300	—	—	300		
START-UP ¹	DELAY	—	1.4	5	—	1.4	5	—	1.4	5	ms	
	OVERSHOOT	—	0	180	—	0	120	—	0	150	mV pk	
	FULL LOAD	—	50	250	—	120	600	—	150	750		
	NO LOAD	—	50	250	—	120	600	—	150	750		

Notes

- Tc = -55°C to +125°C.
- Up to 90% of the total output current/power is available from either output providing the positive output is carrying at least 10% of the total output power.
- Operation is limited below 16 V (see Figure 21).
- Effect on the negative output under the following conditions:
+P_{out} 20% to 80%; -P_{out} 80% to 20%
- Effect on the negative output under the following conditions:
+P_{out} 50%; -P_{out} 10% to 50%
- Tested with 3300 pF ceramic bypass capacitors connected externally from input common to case and output common to case
- Indefinite short circuit protection not guaranteed above 125°C case.
- Recovery time is measured from application of the transient to point at which V_{out} is within 1% of final value.
- Transition time ≥ 10 μs.

SMTR SERIES 30 WATT

DC/DC CONVERTERS

TRIM AND REMOTE SENSE (AVAILABLE ON SINGLE OUTPUT MODELS ONLY)

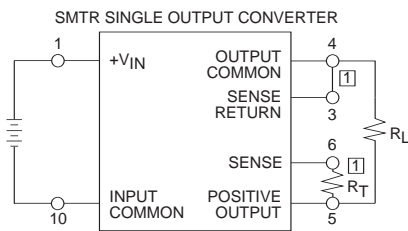

EXTERNAL TRIM CONNECTION
 1 Make connections at converter.

FIGURE 1: TRIM CONNECTION^{1, 2, 3}

Trim Formulas

Vout = desired output voltage; Rt = trim resistor

$$3.3V: R_t = \frac{1300 * V_{out} - 4304}{1.2475}$$

$$5V: R_t = \frac{1300 * V_{out} - 6512}{1.2475}$$

$$12V: R_t = \frac{1300 * V_{out} - 15631}{1.2475}$$

$$15V: R_t = \frac{1300 * V_{out} - 19498}{1.2475}$$

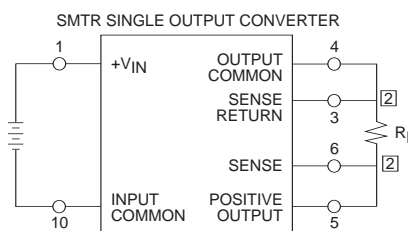

REMOTE SENSE CONNECTION
 2 Make connections at load.

FIGURE 2: REMOTE SENSE^{2, 3}

Notes for Remote Sense and Trim

1. When trimming output voltage and/or remote sensing, the total output voltage increase must be less than 0.6 volts at the converters pins to maintain specified performance.
2. If neither voltage trim nor remote sense will be used, connect pin 3 to pin 4 and pin 5 to pin 6 or the output voltage will increase by 1.2 volts.
3. CAUTION: The converter will be permanently damaged if the positive remote sense (pin 6) is shorted to ground. Damage may also result if the output common or positive output is disconnected from the load with the remote sense leads connected to the load.

PIN OUT

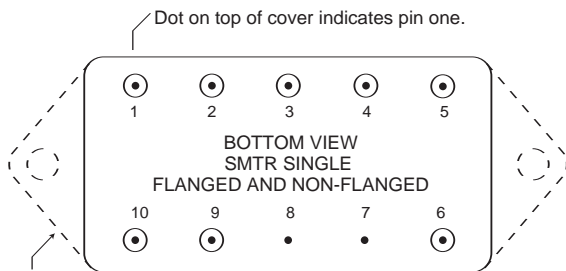

Dotted line outlines flanged package option.
 See Figures 22 and 23 and for dimensions.

FIGURE 3: PIN OUT SINGLE OUTPUT MODELS

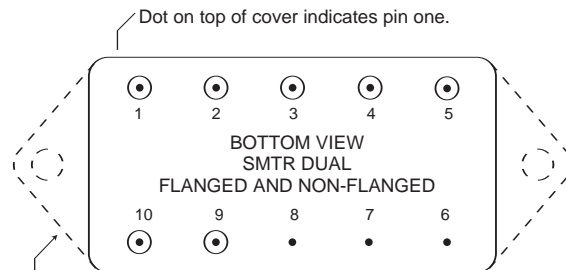

Dotted line outlines flanged package option.

See Figures 24 and 25 for dimensions.

FIGURE 4: PIN OUT DUAL OUTPUT MODELS

Pin	Single Output	Dual Output
1	Positive Input	Positive Input
2	Inhibit	Inhibit
3	Sense Return	Positive Output
4	Output Common	Output Common
5	Positive Output	Negative Output
6	Positive Sense	Case Ground
7	Case Ground	Case Ground
8	Case Ground	Case Ground
9	Sync	Sync
10	Input Common	Input Common

DC/DC CONVERTERS

SMTR SERIES 30 WATT

SMD NUMBERS

STANDARD MICROCIRCUIT DRAWING (SMD)	MTR SERIES SIMILAR PART
5962-0150102HXC	SMTR283R3S/HO
5962-9306802HXC	SMTR2805S/HO
5962-9306902HXC	SMTR2812S/HO
5962-9307002HXC	SMTR2815S/HO
IN PROCESS	SMTR2805D/HO
IN PROCESS	SMTR2812D/HO
IN PROCESS	SMTR2815D/HO

To indicate the flanged case option change the "X" to "Z" in the SMD number. The SMD number shown is for Class H screening, non-flanged, and no Radiation Hardness Assurance (RHA) level. See the SMD for the numbers for other screening and radiation levels. For exact specifications for an SMD product, refer to the SMD drawing. Call your Interpoint representative for status on the SMTR SMD releases which are "in process." SMDs can be downloaded from <http://www.dsccl.dla.mil/programs/smcr>

MODEL NUMBERING KEY

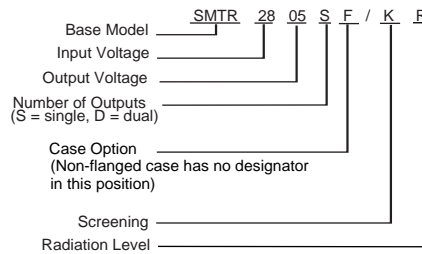

Typical Performance Curves: 25°C Tc, 28 VDC Vin, 100% load, free run, unless otherwise specified.

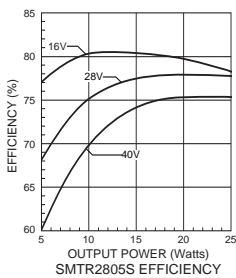

FIGURE 5

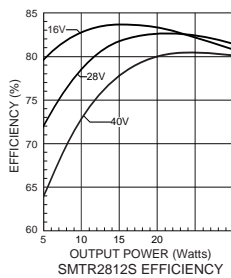

FIGURE 6

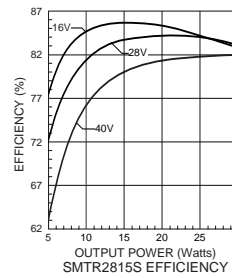

FIGURE 7

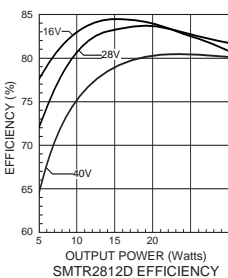

FIGURE 8

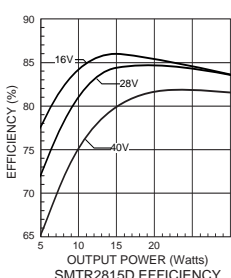

FIGURE 9

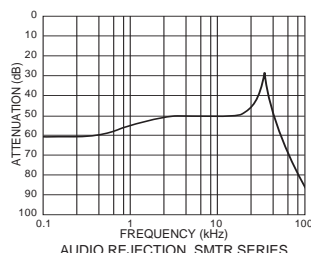

FIGURE 10

SMTR SERIES 30 WATT

DC/DC CONVERTERS

Typical Performance Curves: 25°C Tc, 28 VDC Vin, 100% load, free run, unless otherwise specified.

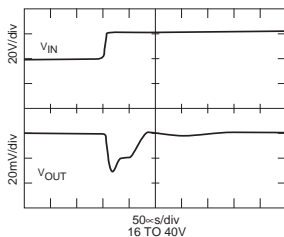

FIGURE 11

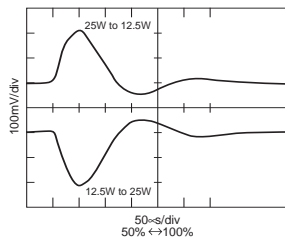

FIGURE 12

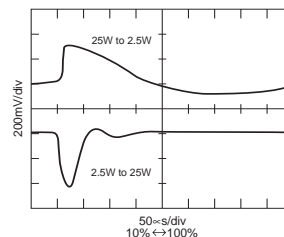

FIGURE 13

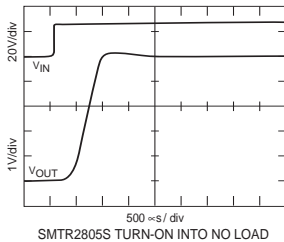

FIGURE 14

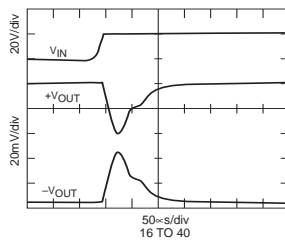

FIGURE 15

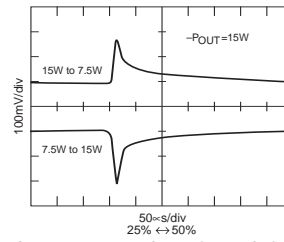

FIGURE 16

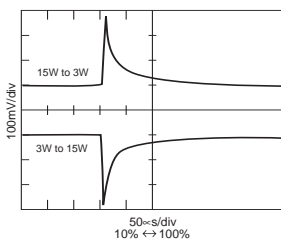

FIGURE 17

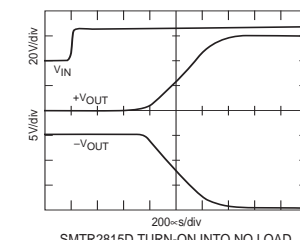

FIGURE 18

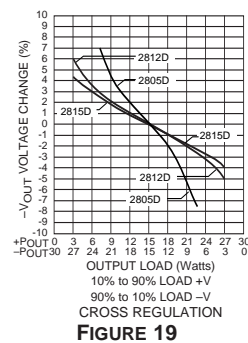

FIGURE 19

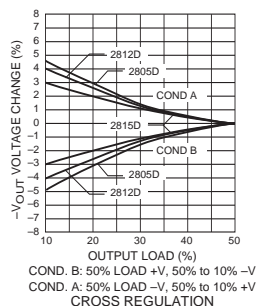

FIGURE 20

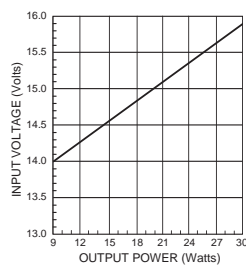
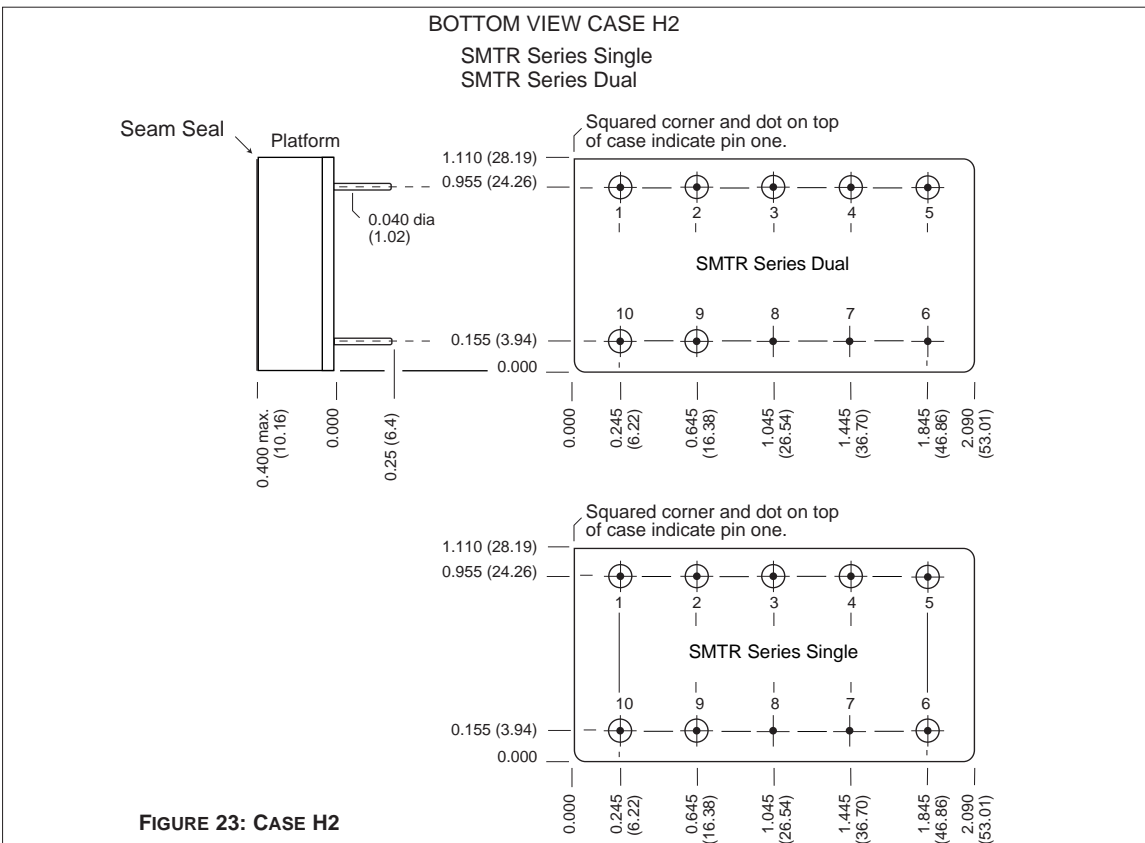
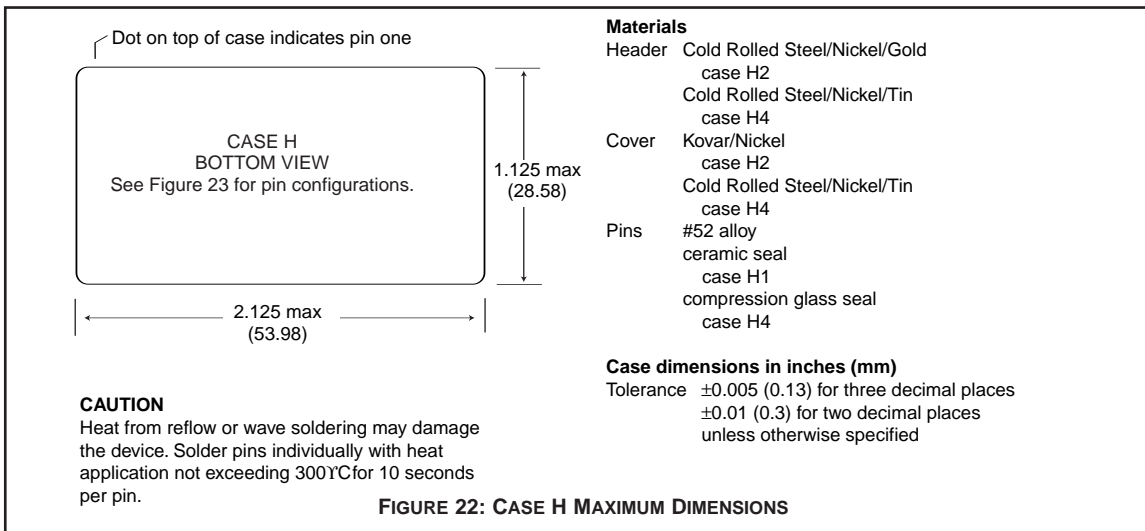

FIGURE 21

DC/DC CONVERTERS

SMTR SERIES 30 WATT



Note: Although every effort has been made to render the case drawings at actual size, variations in the printing process may cause some distortion. Please refer to the numerical dimensions for accuracy.

SMTR SERIES
30 WATT

DC/DC CONVERTERS

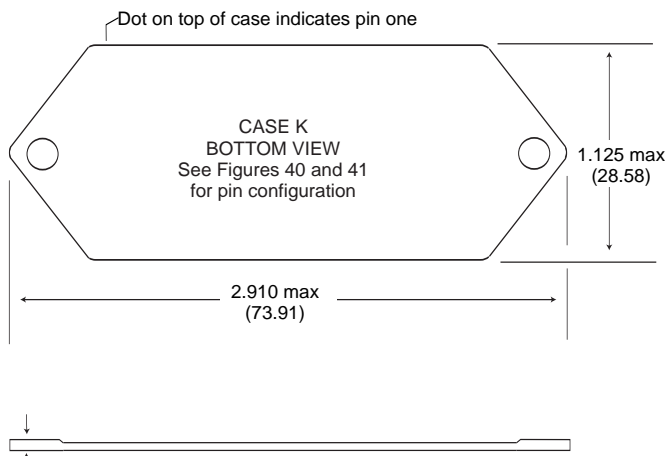

Flange Thickness:

- Case K3 0.060 (1.52)
- Case K5 0.067 +0.005/-0.007 (1.70 +0.13/-0.8)

Materials

- Header Case K3
Cold Rolled Steel/Nickel/Gold
- Case K8
Cold Rolled Steel/Nickel/Tin
- Cover Case K3
Kovar/Nickel
- Case K8
Cold Rolled Steel/Nickel/Tin
- Pins #52 alloy (all cases)
- Case K3
ceramic seal
- Case K8
compression glass seal

Case dimensions in inches (mm)

- Tolerance ± 0.005 (0.13) for three decimal places
- ± 0.01 (0.2) for two decimal places
- unless otherwise specified

CAUTION

Heat from reflow or wave soldering may damage the device. Solder pins individually with heat application not exceeding 300°C for 10 seconds per pin.

FIGURE 24: CASE K MAXIMUM DIMENSIONS

**SMTR SERIES
30 WATT**

DC/DC CONVERTERS

TABLE 1: ELEMENT EVALUATION

ELEMENT EVALUATION TEST PERFORMED (COMPONENT LEVEL)	SPACE PROTOTYPE (O)		CLASS H		CLASS K	
	M/S	P	M/S	P	M/S	P
	Element Electrical	yes	no	yes	yes	yes
Element Visual	no	no	yes	yes	yes	yes
Internal Visual	no	no	yes	no	yes	no
Temperature Cycling	no	no	no	no	yes	yes
Constant Acceleration	no	no	no	no	yes	yes
Interim Electrical	no	no	no	no	yes	no
Burn-in	no	no	no	no	yes	no
Post Burn-in Electrical	no	no	no	no	yes	no
Steady State Life	no	no	no	no	yes	no
Voltage Conditioning /Aging	no	no	no	no	no	yes
Visual Inspection	no	no	no	no	no	yes
Final Electrical	no	no	yes	yes	yes	yes
Wire Bond Evaluation	no	no	yes	yes	yes	yes
SEM	no	no	no	no	yes	no
SLAM™/C-SAM: Input capacitors only (Add'l test, not req. by H or K)	no	no	no	yes	no	yes

Notes

- M/S Active components (Microcircuit and Semiconductor Die)
- P Passive components

Definitions

Element Evaluation: Component testing/screening per MIL-STD-883 as determined by MIL-PRF-38534

SEM: Scanning Electron Microscopy

SLAM™: Scanning Laser Acoustic Microscopy

C-SAM: C - Mode Scanning Acoustic Microscopy

DC/DC CONVERTERS

SMTR SERIES 30 WATT

TABLE 2: PRODUCT ENVIRONMENTAL SCREENING

ENVIRONMENTAL SCREENING TEST PERFORMED (END ITEM LEVEL)	SPACE PROTOTYPE (O)	CLASS H	CLASS K
Non-destruct bond pull Method 2023	no	no	yes
Pre-cap inspection Method 2017, 2032	yes	yes	yes
Temperature cycle Method 1010, Cond. C	yes	yes	yes
Constant acceleration Method 2001, 3000 g	yes	yes	yes
PIND Test Method 2020, Cond. B	no	yes	yes
Radiography Method 2012	no	no	yes
Pre burn-in test	yes	yes	yes
Burn-in, Method 1015, 125°C			
96 hours	yes	no	no
160 hours	no	yes	no
2 x 160 hour (includes mid BI test)	no	no	yes
Final electrical test MIL-PRF-38534, Group A	yes	yes	yes
Hermeticity test			
Fine Leak, Method 1014, Cond. A	yes	yes	yes
Gross Leak, Method 1014, Cond. C	yes	yes	yes
Final visual inspection Method 2009	yes	yes	yes

Test methods are referenced to MIL-STD-883 as determined by MIL-PRF-38534.

**SMTR SERIES
30 WATT**

DC/DC CONVERTERS

TABLE 3: RADIATION HARDNESS LEVELS

PRODUCT LEVEL AVAILABILITY	ENVIRONMENTAL SCREENING LEVELS		
	SPACE PROTOTYPE (O)	CLASS H	CLASS K
RADIATION HARDNESS LEVELS O: Standard, no radiation guarantee For system evaluation, electrically and mechanically comparable to H and K level.	OO	HO	Not available
R: Radiation hardened – Tested lots Up to 100 k Rads (Si) total dose SEU guarantee up to 40 MeV	Not available	HR	KR

R is referenced to MIL-PRF-38534, appendix G, Radiation Hardness Assurance (RHA) levels.

Contact Information:

www.interpoint.com

Interpoint Headquarters USA
Phone: 1-800-822-8782
+425-882-3100
Email: power@intp.com

Interpoint UK
Phone: +44-1252-872266
Email: poweruk@intp.com

Interpoint France
Phone: +33-134285455
Email: powerfr@intp.com