

WJ-L1/SML1

5 TO 3000 MHz TO-8 THIN-FILM LIMITER MODULE

- ◆ AVAILABLE IN SURFACE MOUNT
- ◆ VOLTAGE VARIABLE LIMITING LEVEL:
-10 TO 0 dBm
- ◆ LOW INSERTION LOSS AT LOW INPUT LEVELS: < 2.0 dB (TYP.)
- ◆ GOOD SUPPRESSION OF EVEN ORDER HARMONICS DUE TO BALANCED CIRCUIT DESIGN
- ◆ EXCELLENT PHASE RESPONSE
0.3 DEGREE/dB TO 160 MHz (TYP.)

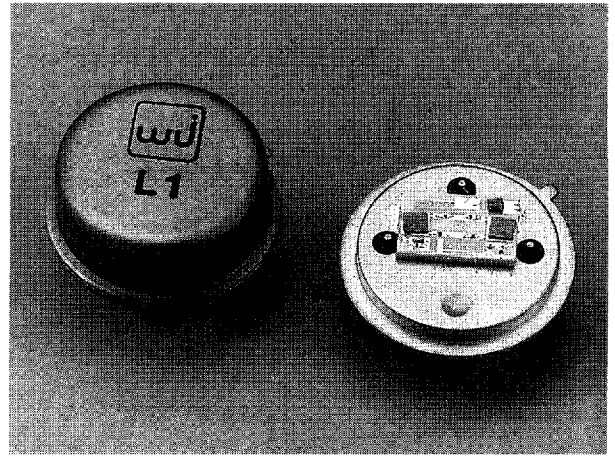

Outline Drawing

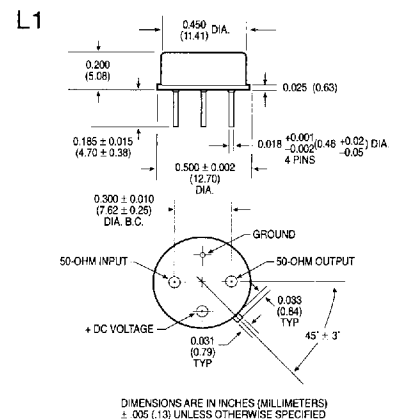

SML1

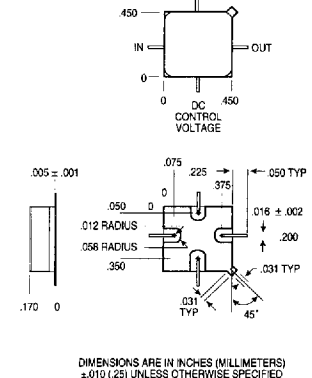

CL1

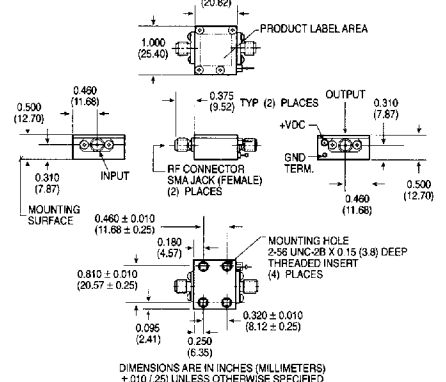

Specifications*

Characteristics	Typical	Guaranteed
Frequency (Min.)	5 - 3200 MHz	5 - 3000 MHz
Insertion Loss (Max.) $P_{IN} \leq -20$ dBm		
5 - 1000 MHz	2.0 dB	3.0 dB
1000 - 3000 MHz	3.0 dB	4.5 dB
Input VSWR (Max.) ($P_{IN} < -10$ dBm, $+10 \leq \text{Bias} \leq +20$ Volts)	1.7:1	1.9:1
Output VSWR (Max.) ($P_{IN} < -10$ dBm, $+10 \leq \text{Bias} \leq +20$ Volts)		
5 - 1000 MHz	1.7:1	2.0:1
1000 - 3000 MHz	2.0:1	2.3:1
Output Limiting Level (Max.) $P_{IN} = +20$ dBm		
5 - 2000 MHz	2.5 dBm	4.0 dBm
2000 - 3000 MHz	6.5 dBm	7.0 dBm
Bias Current (Max.) At 15 Vdc	7 mA	
At 20 Vdc	10 mA	

*Measured in a 50-ohm system at +15 Vdc Nominal guaranteed at 25°C.

Limiting and Insertion Loss Characteristics (25°C)

Bias Voltage	Output Level at Limiting Threshold (1 dB Compression) Typ.	Max. output Limiting Level (+20 dBm Input) Typ.	Insertion Loss (500 MHz) Typ.	Insertion Loss (1000 MHz) Typ.
+20 Volts	-1 dBm	2 dBm	1.7 dB	1.9 dB
+15 Volts	-2 dBm	0 dBm	1.9 dB	2.1 dB
+10 volts	-5 dBm	-2 dBm	2.3 dB	2.5 dB
+5 Volts	-12 dBm	-5 dBm	3.6 dB	3.9 dB

Weight approximately 2.0 grams (0.07 oz.)

Absolute Maximum Ratings

Storage Temperature

..... -62°C to +125°C

Maximum Case Temperature

..... 125°C

Maximum DC Voltage

..... +25 Volts

Maximum Continuous RF Input Power

..... +20 dBm

Maximum Short Term RF Input Power

Input Power (1 Minute Max.)

..... 400 Milliwatts

Maximum Peak Power

..... 1 Watt

(3 μsec Max.)

"S" Series Burn-In

Temperature (Case) 125°C

Typical Applications

1. User wants to limit signal to his device to a level of 0 dBm.

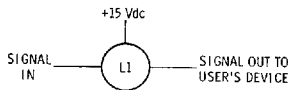

In this case the signal into the user's device will not exceed 0 dBm for incident signal levels to the WJ-L1 as high as +25 dBm.

2. User wants to limit signal to his device to a level above 0 dBm.

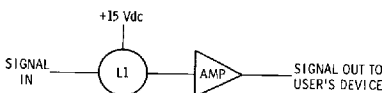

In this case the signal into the user's device will be limited to the output of the amplifier with a maximum of 0 dBm to the amplifier input. (Example: If a WJ-A7 is used with +24V DC bias an output signal of +14 dBm could be available to the user's device.)

3. Wide input range with constant output.

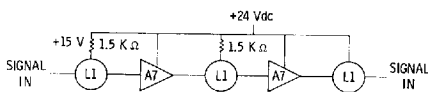

In this case the output signal level will be typically 0 dBm ±0.5 dBm for input level variation from -25 dBm to +25 dBm. Up to six pairs of limiters and amplifiers can be cascaded for extended dynamic range.

Typical Performance at 25°C

Insertion Loss

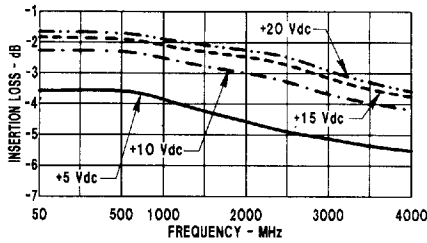

Maximum Limiting Level

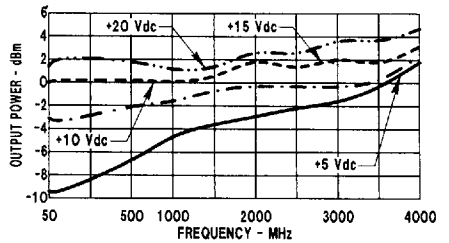

Input VSWR vs. Frequency

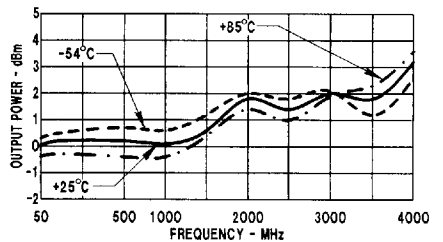
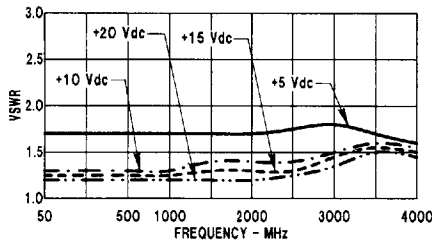

Output VSWR vs. Frequency

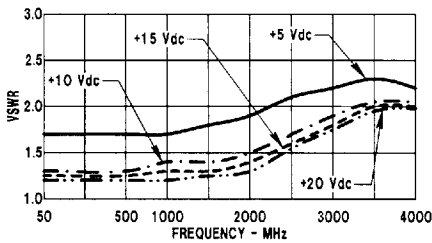

Output Power*

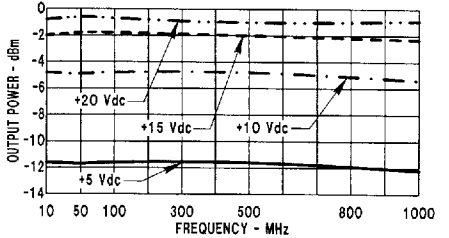

*at 1 dB Compression

Phase Shift vs. Input Power

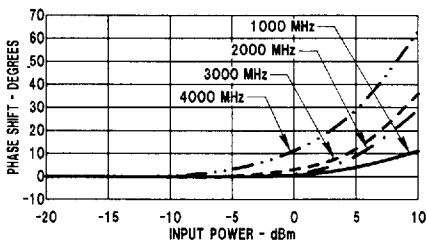
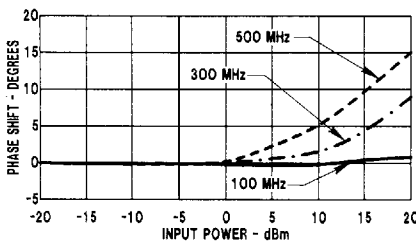

Limiting Characteristics

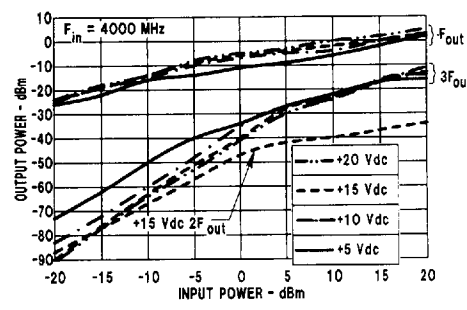
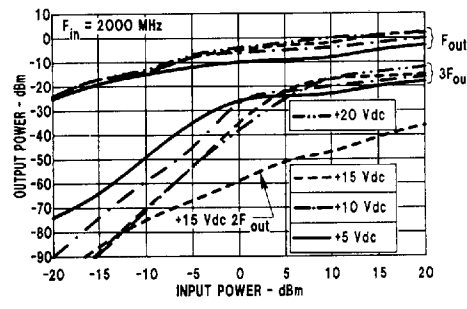
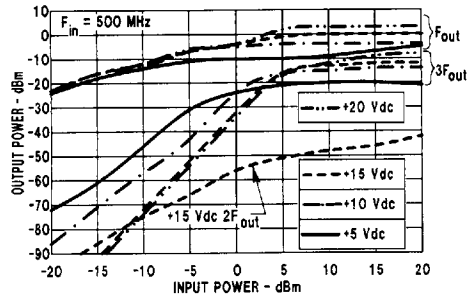
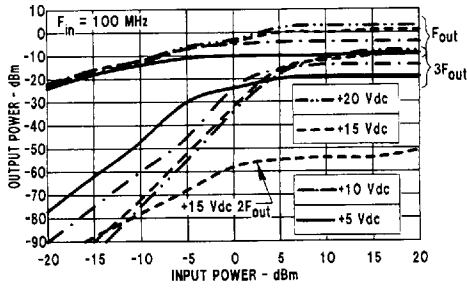

Typical Automatic Test Data

V_{CC} = 15.0 V

Frequency MHz	VSWR IN	VSWR OUT	GAIN DB
1.0	1.8	1.8	-2.0
2.0	1.4	1.4	-1.7
5.0	1.2	1.2	-1.6
10.0	1.2	1.2	-1.6
50.0	1.2	1.2	-1.6
100.0	1.2	1.2	-1.6
200.0	1.2	1.2	-1.7
300.0	1.2	1.2	-1.8
400.0	1.2	1.2	-1.7
500.0	1.2	1.2	-1.8
600.0	1.2	1.2	-1.8
700.0	1.2	1.3	-1.7
800.0	1.2	1.3	-1.8
900.0	1.2	1.3	-1.9
1000.0	1.1	1.3	-1.8
1100.0	1.1	1.3	-1.8
1200.0	1.1	1.3	-1.8
1300.0	1.1	1.3	-1.8
1400.0	1.1	1.3	-1.9
1500.0	1.1	1.4	-1.9
1600.0	1.1	1.4	-1.9
1700.0	1.0	1.4	-1.9
1800.0	1.1	1.5	-2.1
1900.0	1.1	1.5	-2.3
2000.0	1.1	1.6	-2.3
2100.0	1.2	1.6	-2.4
2200.0	1.2	1.6	-2.3
2300.0	1.2	1.7	-2.4
2400.0	1.2	1.7	-2.4
2500.0	1.2	1.8	-2.4
2600.0	1.3	1.8	-2.5
2700.0	1.3	1.8	-2.3
2800.0	1.4	1.8	-2.5
2900.0	1.4	1.9	-2.7
3000.0	1.4	1.9	-2.7

Linear S-Parameters

Frequency MHz	S11		S21		S12		S22	
	MAG	ANG	MAG	ANG	MAG	ANG	MAG	ANG
1.0	.280	-54	.796	17	.800	16	.277	-56
2.0	.160	-50	.826	9	.822	9	.163	-50
5.0	.101	-30	.830	3	.832	3	.103	-30
10.0	.090	-18	.831	1	.830	1	.090	-18
50.0	.081	-12	.832	-2	.830	-2	.087	-12
100.0	.086	-16	.834	-5	.830	-5	.088	-20
200.0	.083	-34	.825	-10	.824	-9	.091	-36
300.0	.088	-53	.817	-14	.822	-14	.094	-53
400.0	.080	-68	.821	-19	.821	-18	.100	-69
500.0	.081	-81	.814	-23	.817	-23	.105	-83
600.0	.071	-100	.812	-28	.815	-28	.110	-97
700.0	.080	-109	.819	-32	.814	-32	.112	-109
800.0	.075	-127	.813	-36	.819	-36	.115	-120
900.0	.073	-138	.806	-41	.816	-41	.120	-128
1000.0	.068	-146	.813	-45	.813	-46	.123	-137
1100.0	.056	-157	.815	-50	.812	-50	.128	-144
1200.0	.057	-164	.811	-55	.804	-55	.133	-151
1300.0	.051	-171	.814	-60	.800	-60	.141	-157
1400.0	.047	-173	.802	-64	.797	-65	.149	-164
1500.0	.038	-158	.802	-69	.795	-70	.157	-170
1600.0	.032	-156	.801	-74	.792	-74	.167	-176
1700.0	.020	-175	.802	-79	.785	-79	.179	-178
1800.0	.026	-172	.783	-83	.784	-83	.191	-171
1900.0	.052	-179	.769	-88	.774	-88	.204	-163
2000.0	.043	-160	.766	-94	.776	-93	.217	-155
2100.0	.072	-171	.756	-99	.770	-98	.229	-147
2200.0	.075	-174	.765	-103	.764	-103	.242	-138
2300.0	.094	-162	.761	-109	.760	-107	.252	-129
2400.0	.108	-147	.761	-112	.754	-112	.261	-120
2500.0	.106	-142	.756	-118	.752	-117	.273	-112
2600.0	.129	-130	.753	-123	.745	-122	.278	-103
2700.0	.133	-114	.766	-128	.738	-127	.289	-95
2800.0	.167	-109	.753	-133	.736	-132	.295	-86
2900.0	.157	-92	.736	-140	.738	-138	.301	-78
3000.0	.182	-77	.729	-146	.711	-144	.303	-70