

MATRIX SURROUND SOUND PROCESSOR WITH SOUND PROCESSOR

The μ PC1892 is a specific IC to reproduce surround sound by using phase shifters and a signal matrix.

The μ PC1892 provides wide sound with two speakers, and rich stereophonic sound with three speakers.

In case of stereo signal, the μ PC1892 has the movie mode to reproduce sense of immediacy (for movie) and the music mode to emphasize vocal sound (for music), and it has the simulated mode to make monaural signal into wide deep sound. The modes can be selected freely by using 2-bit parallel control pins.

In addition to this function reproducing surround sound, the μ PC1892 has a general sound processor that has volume, balance, bass and treble control. So it is capable of reducing installation area.

All functions for processing signals of base band sound are provided on one chip.

FEATURES

- Three surround modes are available: movie, music and simulated
- Built in volume and balance control (All control voltage: 0 V to 5 V)
- Built in tone control (bass, treble) (All control voltage: 0 V to 5 V)
- Built in L+R output for woofer SP
- μ PC1892CT-02: The volume and balance attenuation are bigger than μ PC1892CT.

APPLICATION

- TV

ORDERING INFORMATION

Part Number	Package
μ PC1892CT	30-pin plastic shrink DIP (400 mil)
μ PC1892CT-02	30-pin plastic shrink DIP (400 mil)

The information in this document is subject to change without notice.

SYSTEM BLOCK DIAGRAM (TV)

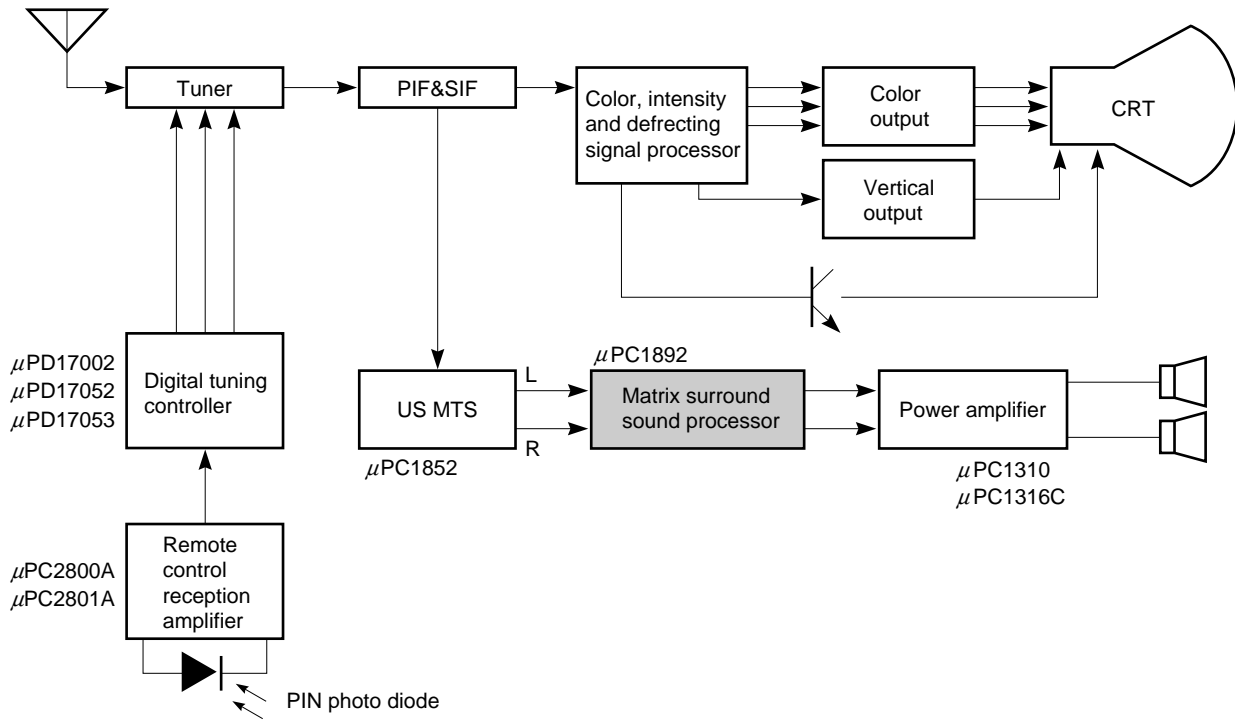

BLOCK DIAGRAM

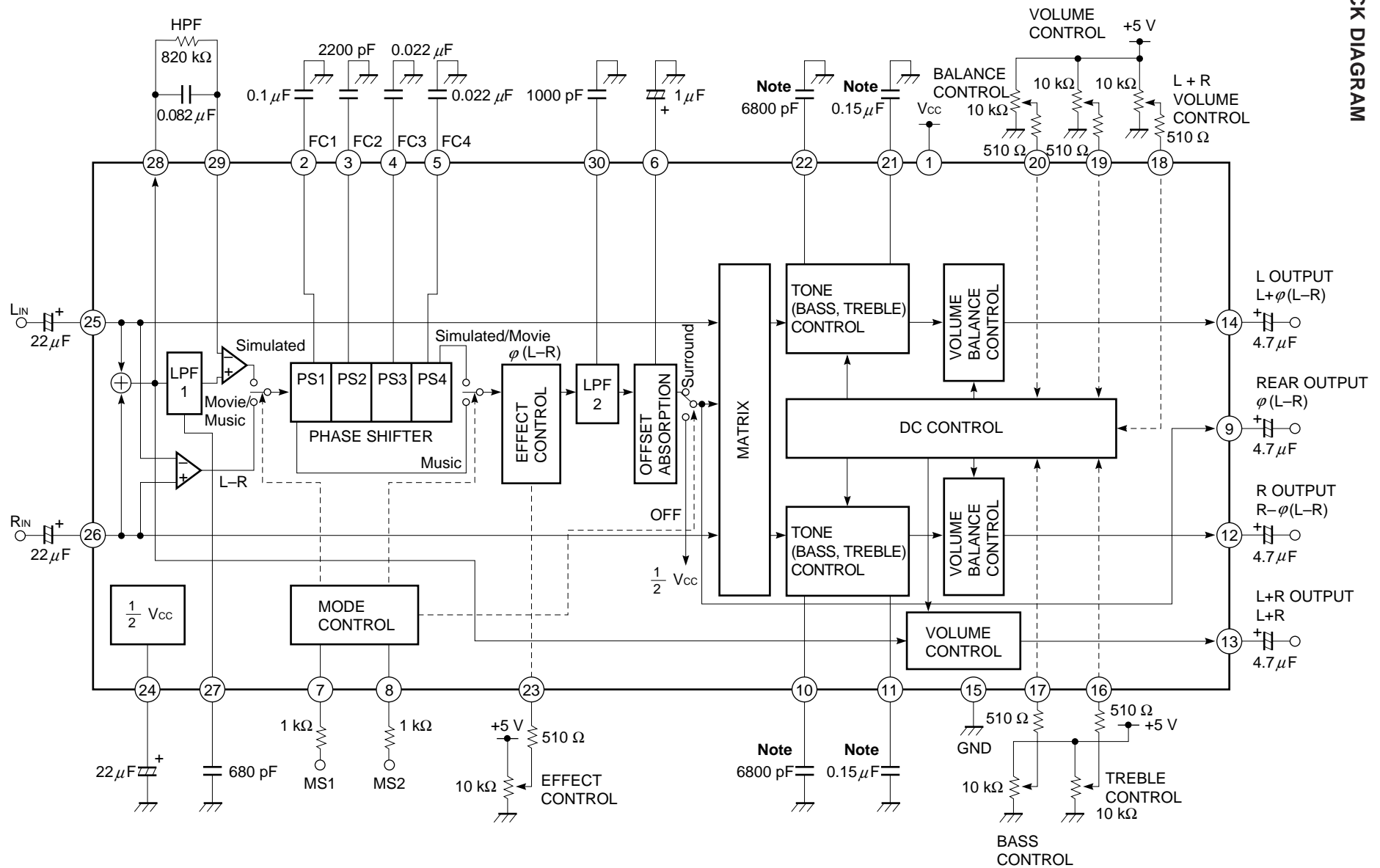

Note Recommended Precision: ±1 %

PIN CONFIGURATIONS (Top View)

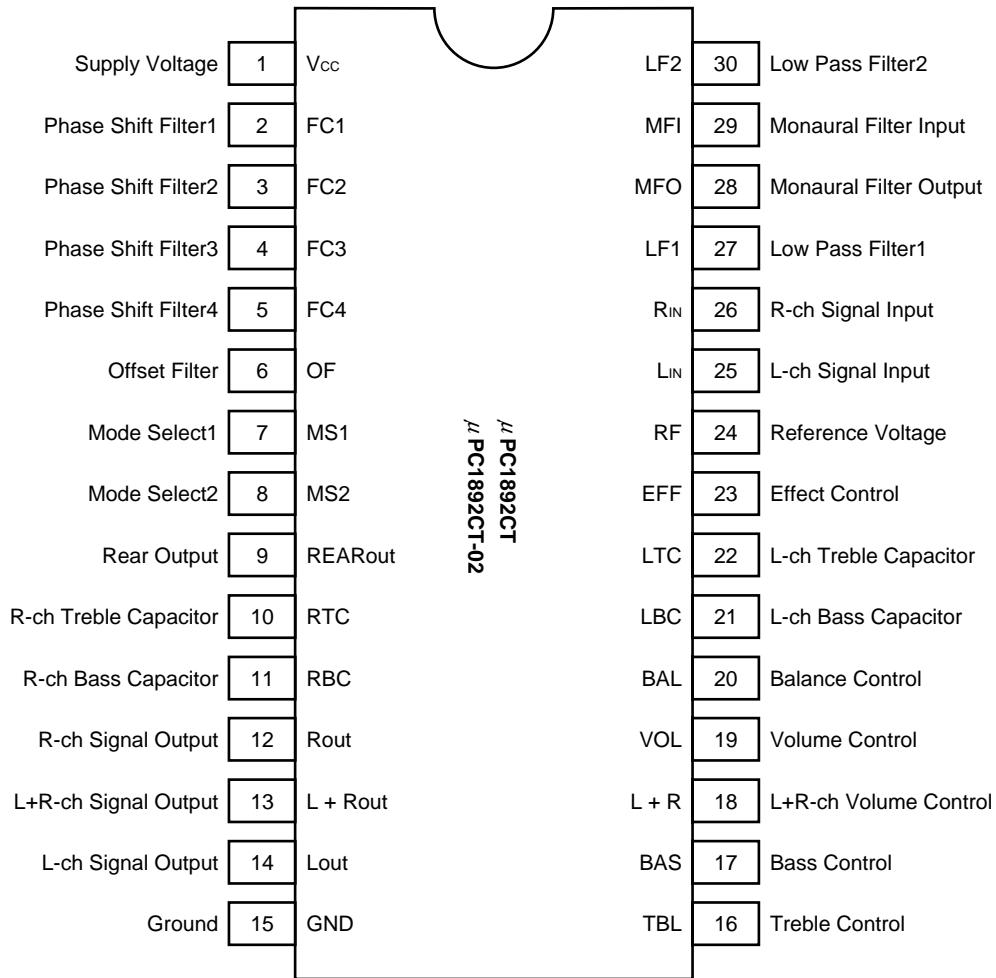

MODE SELECT CODE

Select among OFF, Movie, Music and Simulated mode by MS1 and MS2 (Pins 7 and 8).

Code Mode	MS1 (Pin 7)	MS2 (Pin 8)
OFF	L	L
Music	H	L
Movie	L	H
Simulated	H	H

- Cautions**
1. In the case of changing surround mode and power ON/OFF, mute (approx. 200 ms) must be used for pop noise reduction.
 2. Insert resistors between mode select pins (pin 7, 8) and GND, between control pins (pin 16, 17, 18, 19, 20, 23) and GND.
 3. Connect a electrolytic capacitor for power supply as close as possible to Vcc (pin 1).

Remark About "H" and "L", refer to **RECOMMENDED OPERATING CONDITIONS**.

Explanation of Pins (1/4)

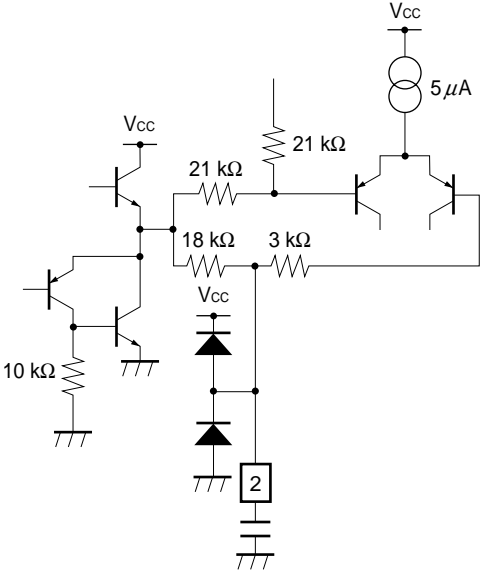
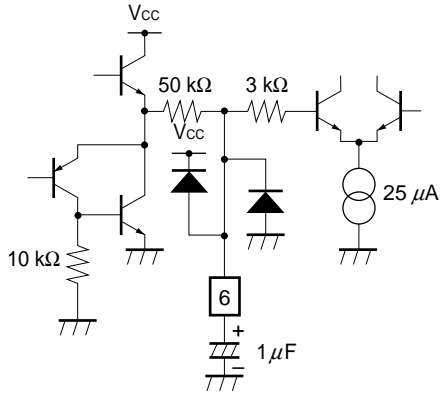
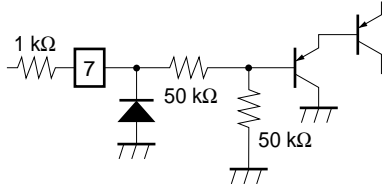
Pin number/name	Equivalent circuit	Description
<p>1 Power supply</p> <p>2 Phase shift filter1</p> <p>3 Phase shift filter2</p> <p>4 Phase shift filter3</p> <p>5 Phase shift filter4</p>	<p>(Pins 3, 4 and 5 are same as pin 2.)</p> 	<p>Power supply pin.</p> <p>Capacitor connection pin which determines time constant of phase shifter.</p> <p>Pin 2 is used for movie, music, simulated mode.</p> <p>Pins 2, 3, 4, 5 is used for movie, simulated mode.</p> <p>Recommended value of capacitor is as follows.</p> <ul style="list-style-type: none"> Pin 2: 0.1 μF Pin 3: 2200 pF Pin 4, 5: 0.022 μF
<p>6 Offset filter</p>		<p>Capacitor connection pin which absorbs offset voltage generated by phase shifter.</p>
<p>7 Mode select1</p> <p>8 Mode select2</p>	<p>(Pin 8 is same as pin 7.)</p> 	<p>Surround mode switch pin.</p> <p>Control by pin 7, 8 (2 bit parallel).</p> <p>Input impedance: approx. 100 kΩ.</p>

Explanation of Pins (2/4)

Pin number/name	Equivalent circuit	Description
9 Rear output 12 R-ch signal output 13 L+R-ch signal output 14 L-ch signal output	(Pins 12, 13 and 14 are same as pin 9.) 	
10 R-ch treble capacitor 22 L-ch treble capacitor	(Pin 22 is same as pin 10.) 	
11 R-ch bass capacitor 21 L-ch bass capacitor	(Pin 21 is same as pin 1.) 	
15 GND	GND	GND pin.

Explanation of Pins (3/4)

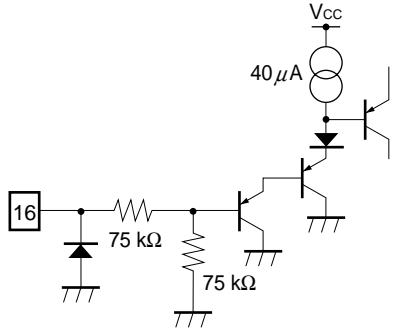
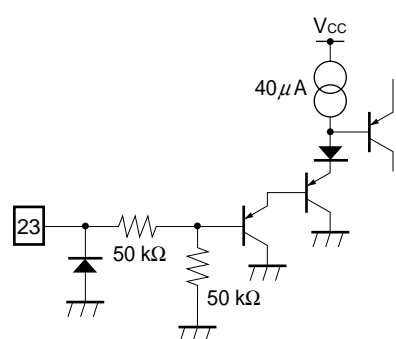
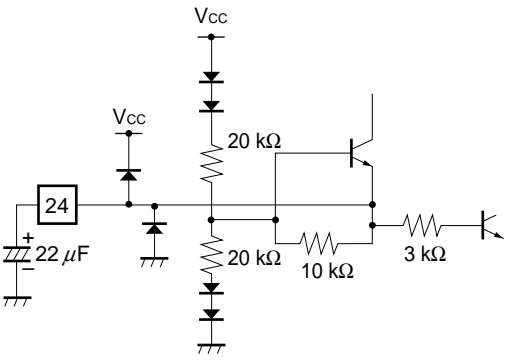
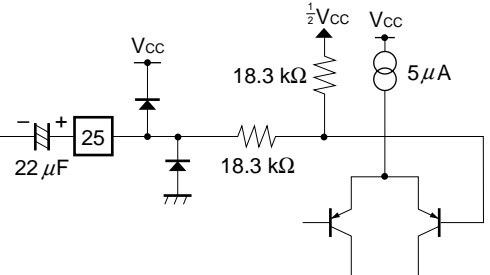
Pin number/name	Equivalent circuit	Description
16 Treble control 17 Bass control 18 L+R-ch volume control 19 Volume control 20 Balance control	(Pins 17, 18, 19 and 20 are same as pin 16.) 	Sound control pin.
23 Effect control		Surround effect control pin. Input impedance: approx. 100 kΩ.
24 Reference voltage		
25 L-ch signal input 26 R-ch signal input	(Pin 26 is same as pin 25.) 	Input impedance: approx. 40 kΩ.

Explanation of Pins (4/4)

Pin number/name	Equivalent circuit	Description
<p>27 Low pass filter1 28 Monaural filter output 29 Monaural filter input</p>		<p>Pins 28, 29 are for HPF at simulated mode. Connect capacitor and resistor between pin 28 and 29.</p>
<p>30 Low pass filter2</p>		

ELECTRICAL CHARACTERISTICS

Absolute Maximum Ratings (at $T_A = 25\text{ }^\circ\text{C}$)

Parameter	Symbol	Conditions	Ratings	Unit
Supply voltage	V_{CC}	No signal, OFF mode	14.0	V
Input signal level	V_{IN}	Pin 25, 26 Input voltage	V_{CC}	V
Control pin voltage	V_{CONT}	Pin 16, 17, 18, 19, 20, 23 Apply voltage	$V_{CC} + 0.2$	V
Package power dissipation	P_D	$T_A = 75\text{ }^\circ\text{C}$	640	mW
Operating temperature	T_A	$V_{CC} = 12\text{ V}$	-20 to +75	$^\circ\text{C}$
Storage temperature	T_{stg}		-40 to +125	$^\circ\text{C}$

Recommended Operating Conditions

Parameter	Symbol	Conditions	MIN.	TYP.	MAX.	Unit
Supply voltage	V_{CC}	No signal, OFF mode	10.8	12.0	13.2	V
Input signal level 1	V_{IN1}	$V_{CC} = 12\text{ V}$, OFF mode, T.H.D = 1 % Volume control voltage = 5.0 V Balance, bass, treble control voltage = 2.5 V	-	1.4	8.5	V_{p-p}
Input signal level 2	V_{IN2}	$V_{CC} = 12\text{ V}$, T.H.D = 1 % L+R volume control voltage = 5.0 V	-	1.4	8.5	V_{p-p}
Output load impedance	P_L	AC load impedance which can be driven by output of pin 9, 12, 13, 14	10			$k\Omega$
Mode select pin voltage (H)	V_{MSH}	Pin 7, 8 Apply voltage	3.5	5.0	V_{CC}	V
Mode select pin voltage (L)	V_{MSL}	Pin 7, 8 Apply voltage	0	0	2.0	V
Effect pin voltage (H)	V_{EFFH}	Pin 23 Upper limit voltage	-	5.0	V_{CC}	V
Effect pin voltage (L)	V_{EFFL}	Pin 23 Lower limit voltage	0	0	-	V
Control pin voltage (H)	V_{CONTH}	Pin 16, 17, 18, 19, 20 Apply voltage	-	5.0	V_{CC}	V
Control pin voltage (L)	V_{CONTL}	Pin 16, 17, 18, 19, 20 Apply voltage	0	0	-	V

Electrical characteristics (T_A = 25 °C, RH ≤ 70 %, V_{CC} = 12 V)

General

Parameter	Symbol	Test conditions Note 1	Control pin voltage (V)				Surround mode	MIN.	TYP.	MAX.	Unit	
			Note 1									Note 2
			Volume	Balance	Treble	Bass						
Supply current	I _{CC}	No signal	–	–	–	–	OFF	23	29	37	mA	
Maximum output voltage	V _{OM}	V _{CC} = 12 V, T.H.D. = 1 %	H	M	M	M	OFF	8.5	9.9		V _{p-p}	
Distortion factor	T.H.D.	V _{IN} = 0.5 V _{r.m.s.} , f = 1 kHz	H	M	M	M	OFF	–	0.1	0.5	%	
L+R distortion factor	T.H.D. (L+R)	V _{IN} = 0.5 V _{r.m.s.} , f = 1 kHz, L+R volume control voltage: 5.0 V	–	–	–	–	–	–	0.1	0.5	%	

Note 1. H: 5.0 V, M: 2.5 V, L: 0 V, –: Undefined

2. OFF: OFF mode, –: Undefined

μPC1892CT Volume control, tone control block (1/1)

Parameter	Symbol	Test conditions ^{Note 1}	Control pin voltage (V)				Surround mode	MIN.	TYP.	MAX.	Unit	
			Note 1									Note 2
			Volume	Balance	Treble	Bass						
Volume attenuation	ATT _{VOL}	V _{IN} = 0.5 V _{r.m.s.} , f = 1 kHz, Volume control voltage: 0.2 V 0 dB: Volume control voltage = H Filter: JIS-A	H ↓ 0.2	M	M	M	OFF	-	-80	-72	dB	
L+R volume attenuation	ATT _{L+RVOL}	V _{IN} = 0.5 V _{r.m.s.} , f = 1 kHz, L+R volume control voltage: 0.2 V 0 dB: L+R volume control voltage = H Filter: JIS-A	-	-	-	-	-	-	-85	-75	dB	
Balance attenuation L-ch	ATT _{BALL}	V _{IN} = 0.5 V _{r.m.s.} , f = 1 kHz, Balance control voltage: 4.5 V 0 dB: Balance control voltage = M Filter: JIS-A	H	M ↓ 4.5	M	M	OFF	-22	-18	-12	dB	
Balance attenuation R-ch	ATT _{BALR}	V _{IN} = 0.5 V _{r.m.s.} , f = 1 kHz, Balance control voltage: 0.5 V 0 dB: Balance control voltage = M Filter: JIS-A	H	M ↓ 0.5	M	M	OFF	-22	-18	-12	dB	
Low-band boost control	V _{BB}	V _{IN} = 0.5 V _{r.m.s.} , f = 100 Hz, Bass control voltage: 4.5 V 0 dB: Bass control voltage = M	H	M	M	M ↓ 4.5	OFF	7	10	13	dB	
Low-band cut control	V _{BC}	V _{IN} = 0.5 V _{r.m.s.} , f = 100 Hz, Bass control voltage: 0.5 V 0 dB: Bass control voltage = M	H	M	M	M ↓ 0.5	OFF	-13	-10	-7	dB	
High-band boost control	V _{TB}	V _{IN} = 0.5 V _{r.m.s.} , f = 10 kHz, Treble control voltage: 4.5 V 0 dB: Treble control voltage = M	H	M	M ↓ 4.5	M	OFF	7	10	13	dB	
High-band cut control	V _{TC}	V _{IN} = 0.5 V _{r.m.s.} , f = 10 kHz, Treble control voltage: 0.5 V 0 dB: Treble control voltage = M	H	M	M ↓ 0.5	M	OFF	-13	-10	-7	dB	

Note 1. H: 5.0 V, M: 2.5 V, L: 0 V, -: Undefined, The alphanumeric numbers in this table represent the level (V).

2. OFF: OFF mode, -: Undefined

μ PC1892CT-02 Volume control, tone control block (1/1)

Parameter	Symbol	Test conditions Note 1	Control pin voltage (V)				Surround mode	MIN.	TYP.	MAX.	Unit	
			Note 1									Note 2
			Volume	Balance	Treble	Bass						
Volume attenuation	ATT _{VOL}	V _{IN} = 0.5 V _{r.m.s.} , f = 1 kHz, Volume control voltage: 0.2 V 0 dB: Volume control voltage = H Filter: JIS-A	H ↓ 0.2	M	M	M	OFF	-	-	-90	dB	
L+R volume attenuation	ATT _{L+RVOL}	V _{IN} = 0.5 V _{r.m.s.} , f = 1 kHz, L+R volume control voltage: 0.2 V 0 dB: L+R volume control voltage = H Filter: JIS-A	-	-	-	-	-	-	-85	-75	dB	
Balance attenuation 1 L-ch	ATT _{BALL1}	V _{IN} = 0.5 V _{r.m.s.} , f = 1 kHz, Balance control voltage: 4.3 V 0 dB: Balance control voltage = M Filter: JIS-A	H	M ↓ 4.3	M	M	OFF	-19	-16	-10	dB	
Balance attenuation 2 L-ch	ATT _{BALL2}	V _{IN} = 0.5 V _{r.m.s.} , f = 1 kHz, Balance control voltage: 5 V 0 dB: Balance control voltage = M Filter: JIS-A	H	M ↓ 5.0	M	M	OFF	-	-	-90	dB	
Balance attenuation 1 R-ch	ATT _{BALR1}	V _{IN} = 0.5 V _{r.m.s.} , f = 1 kHz, Balance control voltage: 0.7 V 0 dB: Balance control voltage = M Filter: JIS-A	H	M ↓ 0.7	M	M	OFF	-19	-16	-10	dB	
Balance attenuation 2 R-ch	ATT _{BALR2}	V _{IN} = 0.5 V _{r.m.s.} , f = 1 kHz, Balance control voltage: 0 V 0 dB: Balance control voltage = M Filter: JIS-A	H	M ↓ 0.0	M	M	OFF	-	-	-90	dB	
Low-band boost control	V _{BB}	V _{IN} = 0.5 V _{r.m.s.} , f = 100 Hz, Bass control voltage: 4.5 V 0 dB: Bass control voltage = M	H	M	M	M ↓ 4.5	OFF	7	10	13	dB	
Low-band cut control	V _{BC}	V _{IN} = 0.5 V _{r.m.s.} , f = 100 Hz, Bass control voltage: 0.5 V 0 dB: Bass control voltage = M	H	M	M	M ↓ 0.5	OFF	-13	-10	-7	dB	
High-band boost control	V _{TB}	V _{IN} = 0.5 V _{r.m.s.} , f = 10 kHz, Treble control voltage: 4.5 V 0 dB: Treble control voltage = M	H	M	M ↓ 4.5	M	OFF	7	10	13	dB	
High-band cut control	V _{TC}	V _{IN} = 0.5 V _{r.m.s.} , f = 10 kHz, Treble control voltage: 0.5 V 0 dB: Treble control voltage = M	H	M	M ↓ 0.5	M	OFF	-13	-10	-7	dB	

Note 1. H: 5.0 V, M: 2.5 V, L: 0 V, -: Undefined, The alphanumeric numbers in this table represent the level (V).

2. OFF: OFF mode, -: Undefined

Matrix surround block (1/3)

Parameter	Symbol	Test conditions Note 1	Control pin voltage (V)					Surround mode	MIN.	TYP.	MAX.	Unit
			Note 1 Note 2									
			Volume	Balance	Treble	Bass						
In-phase gain L+R _{out}	G _{L+R}	V _{IN} = 0.5 V _{r.m.s.} , f = 1 kHz, L+R volume control voltage = H 0 dB: Input level	-	-	-	-	-	-1	0	+1	dB	
In-phase gain OFF mode	G _{OFF}	V _{IN} = 0.5 V _{r.m.s.} , f = 1 kHz, 0 dB: Input level	H	M	M	M	OFF	-1.5	-0.5	+0.5	dB	
In-phase gain Movie mode 1	G _{MOV1}	V _{IN} = 0.5 V _{r.m.s.} , f = 1 kHz, Effect control voltage = M 0 dB: Input level	H	M	M	M	MOV	+4.0	+8.6	+11.0	dB	
In-phase gain Movie mode 2	G _{MOV2}	V _{IN} = 0.5 V _{r.m.s.} , f = 1 kHz, Effect control voltage = H 0 dB: Input level	H	M	M	M	MOV	+6.0	+10.0	+12.5	dB	
In-phase gain Music mode 1	G _{MUS1}	V _{IN} = 0.5 V _{r.m.s.} , f = 1 kHz, Effect control voltage = M 0 dB: Input level	H	M	M	M	MUS	+4.9	+7.0	+8.9	dB	
In-phase gain Music mode 2	G _{MUS2}	V _{IN} = 0.5 V _{r.m.s.} , f = 1 kHz, Effect control voltage = H 0 dB: Input level	H	M	M	M	MUS	+5.9	+8.1	+10.1	dB	
In-phase gain Simulated mode 1 L-ch	G _{SIML1}	V _{IN} = 0.5 V _{r.m.s.} , f = 250 Hz, Effect control voltage = M 0 dB: Input level	H	M	M	M	SIM	+1.7	+4.2	+6.1	dB	
In-phase gain Simulated mode 2 L-ch	G _{SIML2}	V _{IN} = 0.5 V _{r.m.s.} , f = 1 kHz, Effect control voltage = M 0 dB: Input level	H	M	M	M	SIM	-	-5.2	-1.2	dB	
In-phase gain Simulated mode 3 L-ch	G _{SIML3}	V _{IN} = 0.5 V _{r.m.s.} , f = 3.6 kHz, Effect control voltage = M 0 dB: Input level	H	M	M	M	SIM	+4.5	+7.3	+9.4	dB	
In-phase gain Simulated mode 1 R-ch	G _{SIMR1}	V _{IN} = 0.5 V _{r.m.s.} , f = 250 Hz, Effect control voltage = M 0 dB: Input level	H	M	M	M	SIM	-	-7.0	-1.0	dB	
In-phase gain Simulated mode 2 R-ch	G _{SIMR2}	V _{IN} = 0.5 V _{r.m.s.} , f = 1 kHz, Effect control voltage = M 0 dB: Input level	H	M	M	M	SIM	+1.7	+3.6	+5.2	dB	
In-phase gain Simulated mode 3 R-ch	G _{SIMR3}	V _{IN} = 0.5 V _{r.m.s.} , f = 3.6 kHz, Effect control voltage = M 0 dB: Input level	H	M	M	M	SIM	-	-7.6	+0.9	dB	
L, R in-phase gain difference OFF mode	DG _{OFF}	V _{IN} = 0.5 V _{r.m.s.} , f = 1 kHz, DG _{OFF} = (R _{IN} →R _{OUT}) - (L _{IN} →L _{OUT})	H	M	M	M	OFF	-1	0	+1	dB	
L, R in-phase gain difference Movie mode	DG _{MOV}	V _{IN} = 0.5 V _{r.m.s.} , f = 1 kHz, Effect control voltage = M DG _{MOV} = (R _{IN} →R _{OUT}) - (L _{IN} →L _{OUT})	H	M	M	M	MOV	-2	0	+2	dB	

Note 1. H: 5 V, M: 2.5 V, L: 0 V, -: Undefined

2. OFF: OFF mode, MOV: Movie mode, MUS: Music mode, SIM: Simulated mode, -: Undefined

Matrix surround block (2/3)

Parameter	Symbol	Test conditions Note 1	Control pin voltage (V)				Surround mode	MIN.	TYP.	MAX.	Unit	
			Note 1									Note 2
			Volume	Balance	Treble	Bass						
L, R in-phase gain difference Music mode	DGMUS	$V_{IN} = 0.5 V_{r.m.s.}$, $f = 1$ kHz, Effect control voltage = M $DGMUS = (R_{IN} \rightarrow R_{OUT}) - (L_{IN} \rightarrow L_{OUT})$	H	M	M	M	MUS	-2	0	+2	dB	
Rear output gain 1	G _{REAR1}	$V_{IN} = 0.5 V_{r.m.s.}$, $f = 1$ kHz, Effect control voltage = M $G_{REAR1} = R_{IN} (L_{IN}) \rightarrow REAR_{out}$	-	-	-	-	MUS	-5.0	-3.0	-1.1	dB	
Rear output gain 2	G _{REAR2}	$V_{IN} = 0.5 V_{r.m.s.}$, $f = 1$ kHz, Effect control voltage = H $G_{REAR2} = R_{IN} (L_{IN}) \rightarrow REAR_{out}$	-	-	-	-	MUS	-3.0	-1.2	+0.5	dB	
Rear output gain 3	G _{REAR3}	$V_{IN} = 0.5 V_{r.m.s.}$, $f = 1$ kHz, Effect control voltage = M $G_{REAR3} = R_{IN} (L_{IN}) \rightarrow REAR_{out}$	-	-	-	-	MOV	-0.4	+1.6	+3.5	dB	
Rear output gain 4	G _{REAR4}	$V_{IN} = 0.5 V_{r.m.s.}$, $f = 1$ kHz, Effect control voltage = H $G_{REAR4} = R_{IN} (L_{IN}) \rightarrow REAR_{out}$	-	-	-	-	MOV	+1.4	+3.2	+4.9	dB	
Output noise L+R _{out}	NO _{L+R}	DIN/AUDIO filter used. Input terminal resistor (600 Ω) L+R volume control voltage = H	-	-	-	-	-	-	25	80	μV _{r.m.s.}	
Output noise OFF mode	NO _{OFF}	DIN/AUDIO filter used. Input terminal resistor (600 Ω)	H	M	M	M	OFF	-	25	80	μV _{r.m.s.}	
Output noise Movie mode	NO _{MOV}	DIN/AUDIO filter used. Input terminal resistor (600 Ω)	H	M	M	M	MOV	-	0.1	0.3	mV _{r.m.s.}	
Output noise Music mode	NO _{MUS}	DIN/AUDIO filter used. Input terminal resistor (600 Ω)	H	M	M	M	MUS	-	0.1	0.3	mV _{r.m.s.}	
Output noise Simulated mode	NO _{SIM}	DIN/AUDIO filter used. Input terminal resistor (600 Ω)	H	M	M	M	SIM	-	0.1	0.3	mV _{r.m.s.}	
Crosstalk	CT	$V_{IN} = 0.5 V_{r.m.s.}$, $f = 1$ kHz, BPF (1 kHz) used. $CT = L_{IN} \rightarrow R_{OUT}$, $R_{IN} \rightarrow L_{OUT}$ Input terminal resistor (600 Ω)	H	M	M	M	OFF	-	-80	-70	dB	
Inter-mode offset	V _{OSM}	No signal OFF mode → Music mode OFF mode → Movie mode OFF mode → Simulated mode Simulated mode → Music mode Simulated mode → Movie mode Music mode → Movie mode	H	M	M	M	Note 3	-75	0.0	+75	mV	

Note 1. H: 5 V, M: 2.5 V, L: 0 V, -: Undefined

2. OFF: OFF mode, MOV: Movie mode, MUS: Music mode, SIM: Simulated mode, -: Undefined

3. Refer to test conditions.

Matrix surround block (3/3)

Parameter	Symbol	Test conditions Note 1	Note 1				Note 2 Surround mode	MIN.	TYP.	MAX.	Unit
			Control pin voltage (V)								
			Volume	Balance	Treble	Bass					
DC offset 1	V _{DCOS1}	No signal	H ↓ L	M	M	M	OFF	-100	0.0	+100	mV
DC offset 2	V _{DCOS2}	No signal L+R volume control voltage = H → L	-	-	-	-	-	-100	0.0	+100	mV
DC offset 3	V _{DCOS3}	No signal	H	M ↓ L or H	M	M	OFF	-100	0.0	+100	mV
DC offset 4	V _{DCOS4}	No signal	H	M	M	M ↓ L or H	OFF	-100	0.0	+100	mV
DC offset 5	V _{DCOS5}	No signal	H	M	M ↓ L or H	M	OFF	-100	0.0	+100	mV

Note 1. H: 5 V, M: 2.5 V, L: 0 V.

2. OFF: OFF mode, MOV: Movie mode, MUS: Music mode, SIM: Simulated mode.

Electrical Characteristics Measurement List (Supplement) (at T_A = 25 °C, RH ≤ 70 %, V_{CC} = 12 V)

Recommended Operating Conditions

Parameter	Symbol	Conditions	Note 1 Surround mode	Control pin voltage (V) Note 2					
				VOL	BAL	TRE	BAS	L+R	EFF
Input signal level 1	V _{IN1}	Input level when distortion factor of L _{OUT} (Pin 14) is 1 %, L _{IN} (Pin 25) : f = 1 kHz Input level when distortion factor of R _{OUT} (Pin 12) is 1 %, R _{IN} (Pin 26) : f = 1 kHz	OFF	5.0	2.5	2.5	2.5	–	–
Input signal level 2	V _{IN2}	Input level when distortion factor of L+R _{OUT} (Pin 13) is 1 %, L _{IN} , R _{IN} (Pin 25, 26) : f = 1 kHz	OFF	–	–	–	–	5.0	–

Note 1. OFF: OFF mode

- 2.** VOL: Volume control voltage, BAL: Balance control voltage, TRE: Treble control voltage, BAS: Bass control voltage, L+R: L+R volume control voltage, EFF: Effect control voltage, –: Undefined

Electrical characteristics measurement: General

Parameter	Symbol	Test conditions	Note 1 Surround mode	Control pin voltage (V) Note 2					
				VOL	BAL	TRE	BAS	L+R	EFF
Supply current	I _{CC}	Current flowing to V _{CC} (Pin 1) No signal	OFF	5.0	2.5	2.5	2.5	5.0	2.5
Distortion factor	T.H.D.	L-channel Distortion factor of L _{OUT} (Pin 14) L _{IN} (Pin 25) : f = 1 kHz, V _{IN} = 0.5 V _{r.m.s.} R-channel Distortion factor of R _{OUT} (Pin 12) R _{IN} (Pin 26) : f = 1 kHz, V _{IN} = 0.5 V _{r.m.s.}	OFF	5.0	2.5	2.5	2.5	–	–
L+R distortion factor	T.H.D. (L+R)	L+R-channel Distortion factor of L+R _{OUT} (Pin 13) L _{IN} (Pin 25), R _{IN} (Pin 26) : f = 1 kHz, V _{IN} = 0.5 V _{r.m.s.}	OFF	–	–	–	–	5.0	–

Note 1. OFF: OFF mode

- 2.** VOL: Volume control voltage, BAL: Balance control voltage, TRE: Treble control voltage, BAS: Bass control voltage, L+R: L+R volume control voltage, EFF: Effect control voltage, –: Undefined

Electrical characteristics measurement: μPC1892CT Volume control, tone control block (1/3)

Parameter	Symbol	Test conditions	Note 1 Surround mode	Control pin voltage (V) Note 2					
				VOL	BAL	TRE	BAS	L+R	EFF
Volume attenuation	ATT _{VOL}	$ATT_{VOL} = 20 \log \frac{V_{ATT}}{V_{REF}}$ L-channel L _{IN} (Pin 25) : f = 1 kHz, V _{IN} = 0.5 V _{r.m.s.} V _{REF} : L _{OUT} (Pin 14) (Volume control voltage : 5.0 V) V _{ATT} : L _{OUT} (Pin 14) (Volume control voltage : 0.2 V) JIS-A filter used. R-channel R _{IN} (Pin 26) : f = 1 kHz, V _{IN} = 0.5 V _{r.m.s.} V _{REF} : R _{OUT} (Pin 12) (Volume control voltage : 5.0 V) V _{ATT} : R _{OUT} (Pin 12) (Volume control voltage : 0.2 V) JIS-A filter used.	OFF	5.0 ↓ 0.2	2.5	2.5	2.5	–	–
L+R volume attenuation	ATT _{L+R}	$ATT_{L+R} = 20 \log \frac{V_{L+RATT}}{V_{L+RREF}}$ L _{IN} , R _{IN} (Pin 25, 26) : f = 1 kHz, V _{IN} = 0.5 V _{r.m.s.} V _{L+RREF} : L+R _{OUT} (Pin 13) (L+R volume control voltage : 5.0 V) V _{L+RATT} : L+R _{OUT} (Pin 13) (L+R volume control voltage : 0.2 V) JIS-A filter used.	OFF	–	–	–	–	5.0 ↓ 0.2	–
Balance attenuation Lch/Rch	ATT _{BALL}	$ATT_{BAL} = 20 \log \frac{V_{ATT}}{V_{REF}}$ L-channel L _{IN} (Pin 25) : f = 1 kHz, V _{IN} = 0.5 V _{r.m.s.} V _{REF} : L _{OUT} (Pin 14) (Balance control voltage : 2.5 V) V _{ATT} : L _{OUT} (Pin 14) (Balance control voltage : 4.5 V) JIS-A filter used. R-channel R _{IN} (Pin 26) : f = 1 kHz, V _{IN} = 0.5 V _{r.m.s.} V _{REF} : R _{OUT} (Pin 12) (Balance control voltage : 2.5 V) V _{ATT} : R _{OUT} (Pin 12) (Balance control voltage : 0.5 V) JIS-A filter used.	OFF	5.0	2.5 ↓ 4.5	2.5	2.5	–	–
	ATT _{BALR}			5.0	2.5 ↓ 0.5	2.5	2.5	–	–

Note 1. OFF: OFF mode

2. VOL: Volume control voltage, BAL: Balance control voltage, TRE: Treble control voltage, BAS: Bass control voltage, L+R: L+R volume control voltage, EFF: Effect control voltage, –: Undefined

Electrical characteristics measurement: μPC1892CT Volume control, tone control block (2/3)

Parameter	Symbol	Test conditions	Note 1 Surround mode	Control pin voltage (V) Note 2					
				VOL	BAL	TRE	BAS	L+R	EFF
Low-band boost control	V _{BB}	$V_{BB} = 20 \log \frac{V_{BST}}{V_{REF}}$ L-channel L _{IN} (Pin 25) : f = 100 Hz, V _{IN} = 0.5 V _{r.m.s.} V _{REF} : L _{OUT} (Pin 14) (Bass control voltage : 2.5 V) V _{BST} : L _{OUT} (Pin 14) (Bass control voltage : 4.5 V) R-channel R _{IN} (Pin 26) : f = 100 Hz, V _{IN} = 0.5 V _{r.m.s.} V _{REF} : R _{OUT} (Pin 12) (Bass control voltage : 2.5 V) V _{BST} : R _{OUT} (Pin 12) (Bass control voltage : 4.5 V)	OFF	5.0	2.5	2.5	2.5 ↓ 4.5	–	–
Low-band cut control	V _{BC}	$V_{BC} = 20 \log \frac{V_{ATT}}{V_{REF}}$ L-channel L _{IN} (Pin 25) : f = 100 Hz, V _{IN} = 0.5 V _{r.m.s.} V _{REF} : L _{OUT} (Pin 14) (Bass control voltage : 2.5 V) V _{ATT} : L _{OUT} (Pin 14) (Bass control voltage : 0.5 V) R-channel R _{IN} (Pin 26) : f = 100 Hz, V _{IN} = 0.5 V _{r.m.s.} V _{REF} : R _{OUT} (Pin 12) (Bass control voltage : 2.5 V) V _{ATT} : R _{OUT} (Pin 12) (Bass control voltage : 0.5 V)	OFF	5.0	2.5	2.5	2.5 ↓ 0.5	–	–
High-band boost control	V _{TB}	$V_{TB} = 20 \log \frac{V_{BST}}{V_{REF}}$ L-channel L _{IN} (Pin 25) : f = 10 kHz, V _{IN} = 0.5 V _{r.m.s.} V _{REF} : L _{OUT} (Pin 14) (Treble control voltage : 2.5 V) V _{BST} : L _{OUT} (Pin 14) (Treble control voltage : 4.5 V) R-channel R _{IN} (Pin 26) : f = 10 kHz, V _{IN} = 0.5 V _{r.m.s.} V _{REF} : R _{OUT} (Pin 12) (Treble control voltage : 2.5 V) V _{BST} : R _{OUT} (Pin 12) (Treble control voltage : 4.5 V)	OFF	5.0	2.5	2.5 ↓ 4.5	2.5	–	–

Note 1. OFF: OFF mode

2. VOL: Volume control voltage, BAL: Balance control voltage, TRE: Treble control voltage, BAS: Bass control voltage, L+R: L+R volume control voltage, EFF: Effect control voltage, –: Undefined

Electrical characteristics measurement: μPC1892CT Volume control, tone control block (3/3)

Parameter	Symbol	Test conditions	Note 1 Surround mode	Control pin voltage (V) Note 2					
				VOL	BAL	TRE	BAS	L+R	EFF
High-band cut control	V _{TC}	$V_{TC} = 20 \log \frac{V_{ATT}}{V_{REF}}$ L-channel L _{IN} (Pin 25) : f = 10 kHz, V _{IN} = 0.5 V _{r.m.s.} V _{REF} : L _{OUT} (Pin 14) (Treble control voltage : 2.5 V) V _{ATT} : L _{OUT} (Pin 14) (Treble control voltage : 0.5 V) R-channel R _{IN} (Pin 26) : f = 10 kHz, V _{IN} = 0.5 V _{r.m.s.} V _{REF} : R _{OUT} (Pin 12) (Treble control voltage : 2.5 V) V _{ATT} : R _{OUT} (Pin 12) (Treble control voltage : 0.5 V)	OFF	5.0	2.5	2.5 ↓ 0.5	2.5	–	–

Note 1. OFF: OFF mode

2. VOL: Volume control voltage, BAL: Balance control voltage, TRE: Treble control voltage, BAS: Bass control voltage, L+R: L+R volume control voltage, EFF: Effect control voltage, –: Undefined

Electrical characteristics measurement: μPC1892CT-02 Volume control, tone control block (1/3)

Parameter	Symbol	Test conditions	Note 1 Surround mode	Control pin voltage (V) Note 2					
				VOL	BAL	TRE	BAS	L+R	EFF
Volume attenuation	ATT _{VOL}	$ATT_{VOL} = 20 \log \frac{V_{ATT}}{V_{REF}}$ L-channel L _{IN} (Pin 25) : f = 1 kHz, V _{IN} = 0.5 V _{r.m.s.} V _{REF} : L _{OUT} (Pin 14) (Volume control voltage : 5.0 V) V _{ATT} : L _{OUT} (Pin 14) (Volume control voltage : 0.2 V) JIS-A filter used. R-channel R _{IN} (Pin 26) : f = 1 kHz, V _{IN} = 0.5 V _{r.m.s.} V _{REF} : R _{OUT} (Pin 12) (Volume control voltage : 5.0 V) V _{ATT} : R _{OUT} (Pin 12) (Volume control voltage : 0.2 V) JIS-A filter used.	OFF	5.0 ↓ 0.2	2.5	2.5	2.5	–	–
L+R volume attenuation	ATT _{L+R}	$ATT_{L+R} = 20 \log \frac{V_{L+RATT}}{V_{L+RREF}}$ L _{IN} , R _{IN} (Pin 25, 26) : f = 1 kHz, V _{IN} = 0.5 V _{r.m.s.} V _{L+RREF} : L+R _{OUT} (Pin 13) (L+R volume control voltage : 5.0 V) V _{L+RATT} : L+R _{OUT} (Pin 13) (L+R volume control voltage : 0.2 V) JIS-A filter used.	OFF	–	–	–	–	5.0 ↓ 0.2	–

Note 1. OFF: OFF mode

2. VOL: Volume control voltage, BAL: Balance control voltage, TRE: Treble control voltage, BAS: Bass control voltage, L+R: L+R volume control voltage, EFF: Effect control voltage, –: Undefined

Electrical characteristics measurement: μPC1892CT-02 Volume control, tone control block (2/3)

Parameter	Symbol	Test conditions	Note 1 Surround mode	Control pin voltage (V) Note 2					
				VOL	BAL	TRE	BAS	L+R	EFF
Balance attenuation Lch/Rch	ATT _{BALL1}	$ATT_{BAL} = 20 \log \frac{V_{ATT}}{V_{REF}}$ L-channel 1 L _{IN} (Pin 25) : f = 1 kHz, V _{IN} = 0.5 V _{r.m.s.} V _{REF} : L _{OUT} (Pin 14) (Balance control voltage : 2.5 V) V _{ATT} : L _{OUT} (Pin 14) (Balance control voltage : 4.3 V) JIS-A filter used.	OFF	5.0	2.5 ↓ 4.3	2.5	2.5	–	–
		L-channel 2 L _{IN} (Pin 25) : f = 1 kHz, V _{IN} = 0.5 V _{r.m.s.} V _{REF} : L _{OUT} (Pin 14) (Balance control voltage : 2.5 V) V _{ATT} : L _{OUT} (Pin 14) (Balance control voltage : 5.0 V) JIS-A filter used.		5.0	2.5 ↓ 5.0	2.5	2.5	–	–
	ATT _{BALL2}	R-channel 1 R _{IN} (Pin 26) : f = 1 kHz, V _{IN} = 0.5 V _{r.m.s.} V _{REF} : R _{OUT} (Pin 12) (Balance control voltage : 2.5 V) V _{ATT} : R _{OUT} (Pin 12) (Balance control voltage : 0.7 V) JIS-A filter used.	5.0	2.5 ↓ 0.7	2.5	2.5	–	–	
		R-channel 2 R _{IN} (Pin 26) : f = 1 kHz, V _{IN} = 0.5 V _{r.m.s.} V _{REF} : R _{OUT} (Pin 12) (Balance control voltage : 2.5 V) V _{ATT} : R _{OUT} (Pin 12) (Balance control voltage : 0.0 V) JIS-A filter used.	5.0	2.5 ↓ 0.0	2.5	2.5	–	–	
Low-band boost control	V _{BB}	$V_{BB} = 20 \log \frac{V_{BST}}{V_{REF}}$ L-channel L _{IN} (Pin 25) : f = 100 Hz, V _{IN} = 0.5 V _{r.m.s.} V _{REF} : L _{OUT} (Pin 14) (Bass control voltage : 2.5 V) V _{BST} : L _{OUT} (Pin 14) (Bass control voltage : 4.5 V) R-channel R _{IN} (Pin 26) : f = 100 Hz, V _{IN} = 0.5 V _{r.m.s.} V _{REF} : R _{OUT} (Pin 12) (Bass control voltage : 2.5 V) V _{BST} : R _{OUT} (Pin 12) (Bass control voltage : 4.5 V)	OFF	5.0	2.5	2.5	2.5 ↓ 4.5	–	–

Note 1. OFF: OFF mode

2. VOL: Volume control voltage, BAL: Balance control voltage, TRE: Treble control voltage, BAS: Bass control voltage, L+R: L+R volume control voltage, EFF: Effect control voltage, –: Undefined

Electrical characteristics measurement: μPC1892CT-02 Volume control, tone control block (3/3)

Parameter	Symbol	Test conditions	Note 1 Surround mode	Control pin voltage (V) Note 2					
				VOL	BAL	TRE	BAS	L+R	EFF
Low-band cut control	V _{BC}	$V_{BC} = 20 \log \frac{V_{ATT}}{V_{REF}}$ <p>L-channel L_{IN} (Pin 25) : f = 100 Hz, V_{IN} = 0.5 V_{r.m.s.} V_{REF} : L_{OUT} (Pin 14) (Bass control voltage : 2.5 V) V_{ATT} : L_{OUT} (Pin 14) (Bass control voltage : 0.5 V)</p> <p>R-channel R_{IN} (Pin 26) : f = 100 Hz, V_{IN} = 0.5 V_{r.m.s.} V_{REF} : R_{OUT} (Pin 12) (Bass control voltage : 2.5 V) V_{ATT} : R_{OUT} (Pin 12) (Bass control voltage : 0.5 V)</p>	OFF	5.0	2.5	2.5	2.5 ↓ 0.5	–	–
High-band boost control	V _{TB}	$V_{TB} = 20 \log \frac{V_{BST}}{V_{REF}}$ <p>L-channel L_{IN} (Pin 25) : f = 10 kHz, V_{IN} = 0.5 V_{r.m.s.} V_{REF} : L_{OUT} (Pin 14) (Treble control voltage : 2.5 V) V_{BST} : L_{OUT} (Pin 14) (Treble control voltage : 4.5 V)</p> <p>R-channel R_{IN} (Pin 26) : f = 10 kHz, V_{IN} = 0.5 V_{r.m.s.} V_{REF} : R_{OUT} (Pin 12) (Treble control voltage : 2.5 V) V_{BST} : R_{OUT} (Pin 12) (Treble control voltage : 4.5 V)</p>	OFF	5.0	2.5	2.5 ↓ 4.5	2.5	–	–
High-band cut control	V _{TC}	$V_{TC} = 20 \log \frac{V_{ATT}}{V_{REF}}$ <p>L-channel L_{IN} (Pin 25) : f = 10 kHz, V_{IN} = 0.5 V_{r.m.s.} V_{REF} : L_{OUT} (Pin 14) (Treble control voltage : 2.5 V) V_{ATT} : L_{OUT} (Pin 14) (Treble control voltage : 0.5 V)</p> <p>R-channel R_{IN} (Pin 26) : f = 10 kHz, V_{IN} = 0.5 V_{r.m.s.} V_{REF} : R_{OUT} (Pin 12) (Treble control voltage : 2.5 V) V_{ATT} : R_{OUT} (Pin 12) (Treble control voltage : 0.5 V)</p>	OFF	5.0	2.5	2.5 ↓ 0.5	2.5	–	–

Note 1. OFF: OFF mode

2. VOL: Volume control voltage, BAL: Balance control voltage, TRE: Treble control voltage, BAS: Bass control voltage, L+R: L+R volume control voltage, EFF: Effect control voltage, –: Undefined

Electrical characteristics measurement: Matrix block (1/5)

Parameter	Symbol	Test conditions	Note 1 Surround mode	Control pin voltage (V) Note 2					
				VOL	BAL	TRE	BAS	L+R	EFF
In-phase gain L+R _{OUT}	G _{L+R}	G _{L+R} : Output level of L+R _{OUT} (Pin 13) L _{IN} (Pin 25), R _{IN} (Pin 26) : f = 1 kHz V _{IN} = 0.5 V _{r.m.s.} 0 dB : Input level L _{IN} (Pin 25), R _{IN} (Pin 26)	OFF	–	–	–	–	5.0	–
In-phase gain OFF mode	G _{OFF}	L -channel G _{OFF} : Output level of L _{OUT} (Pin 14) L _{IN} (Pin 25) : f = 1 kHz, V _{IN} = 0.5 V _{r.m.s.} 0 dB : Input level of L _{IN} (Pin 25) R -channel G _{OFF} : Output level of R _{OUT} (Pin 12) R _{IN} (Pin 26) : f = 1 kHz, V _{IN} = 0.5 V _{r.m.s.} 0 dB : Input level of R _{IN} (Pin 26)	OFF	5.0	2.5	2.5	2.5	–	–
In-phase gain Movie mode 1/2	G _{MOV1} G _{MOV2}	L -channel G _{MOV} : Output level of L _{OUT} (Pin 14) L _{IN} (Pin 25) : f = 1 kHz, V _{IN} = 0.5 V _{r.m.s.} 0 dB : Input level of L _{IN} (Pin 25) R -channel G _{MOV} : Output level of R _{OUT} (Pin 12) R _{IN} (Pin 26) : f = 1 kHz, V _{IN} = 0.5 V _{r.m.s.} 0 dB : Input level of R _{IN} (Pin 26)	MOV	5.0	2.5	2.5	2.5	–	2.5 or 5.0
In-phase gain Music mode 1/2	G _{Mus1} G _{Mus2}	L -channel G _{MUS} : Output level of L _{OUT} (Pin 14) L _{IN} (Pin 25) : f = 1 kHz, V _{IN} = 0.5 V _{r.m.s.} 0 dB : Input level of L _{IN} (Pin 25) R -channel G _{MUS} : Output level of R _{OUT} (Pin 12) R _{IN} (Pin 26) : f = 1 kHz, V _{IN} = 0.5 V _{r.m.s.} 0 dB : Input level of R _{IN} (Pin 26)	MUS	5.0	2.5	2.5	2.5	–	2.5 or 5.0
In-phase gain Simulated mode L-ch 1/2/3	G _{SIML1} G _{SIML2} G _{SIML3}	L -channel G _{SIM} : Output level of L _{OUT} (Pin 14) L _{IN} (Pin 25) : f = 250 Hz/1 kHz/3.6 kHz V _{IN} = 0.5 V _{r.m.s.} 0 dB : Input level of L _{IN} (Pin 25)	SIM	5.0	2.5	2.5	2.5	–	2.5
In-phase gain Simulated mode R-ch 1/2/3	G _{SIMR1} G _{SIMR2} G _{SIMR3}	R -channel G _{SIM} : Output level of R _{OUT} (Pin 12) R _{IN} (Pin 26) : f = 250 Hz/1 kHz/3.6 kHz V _{IN} = 0.5 V _{r.m.s.} 0 dB : Input level of R _{IN} (Pin 26)	SIM	5.0	2.5	2.5	2.5	–	2.5

Note 1. OFF: OFF mode, MOV: Movie mode, MUS: Music mode, SIM: Simulated mode

2. VOL: Volume control voltage, BAL: Balance control voltage, TRE: Treble control voltage, BAS: Bass control voltage, L+R: L+R volume control voltage, EFF: Effect control voltage, –: Undefined

Electrical characteristics measurement: Matrix block (2/5)

Parameter	Symbol	Test conditions	Note 1 Surround mode	Control pin voltage (V) Note 2					
				VOL	BAL	TRE	BAS	L+R	EFF
L, R in-phase gain difference OFF mode Movie mode Music mode	DG _{OFF} DG _{MOV} DG _{MUS}	$DG = 20 \log \frac{VR_{OUT}}{VR_{IN}} - 20 \log \frac{VL_{OUT}}{VL_{IN}}$ VR _{OUT} : Voltage of R _{OUT} (Pin 12) VR _{IN} : Voltage of R _{IN} (Pin 26) (0.5 V _{r.m.s.} , f = 1 kHz) VL _{OUT} : Voltage of L _{OUT} (Pin 14) VL _{IN} : Voltage of L _{IN} (Pin 25) (0.5 V _{r.m.s.} , f = 1 kHz)	OFF MOV MUS	5.0	2.5	2.5	2.5	–	2.5
Rear output gain 1/2/3/4	G _{REAR1} G _{REAR2} G _{REAR3} G _{REAR4}	$G_{REAR} = 20 \log \frac{REAR_{OUT}}{V_{IN}}$ L-channel V _{IN} : Voltage of L _{IN} (Pin 25) (0.5 V _{r.m.s.} , f = 1 kHz) REAR _{OUT} : Voltage of REAR _{OUT} (Pin 9) R-channel V _{IN} : Voltage of R _{IN} (Pin 26) (0.5 V _{r.m.s.} , f = 1 kHz) REAR _{OUT} : Voltage of REAR _{OUT} (Pin 9)	MUS MOV	5.0	2.5	2.5	2.5	–	2.5 or 5.0
Output noise OFF mode L+R _{OUT}	NO _{OFF} NO _{L+R}	NO _{OFF} : Voltage of L _{OUT} (Pin 14), R _{OUT} (Pin 12) through DIN/AUDIO filter. NO _{L+R} : Voltage of L+R _{OUT} (Pin 13) through DIN/AUDIO filter. L _{IN} (Pin 25), R _{IN} (Pin 26) : Connect to the GND with electrolytic capacitor (22 μF) and resistor (600 Ω).	OFF	5.0	2.5	2.5	2.5	5.0	–
Output noise Movie mode	NO _{MOV}	NO _{MOV} : Voltage of L _{OUT} (Pin 14), R _{OUT} (Pin 12) through DIN/AUDIO filter. L _{IN} (Pin 25), R _{IN} (Pin 26) : Connect to the GND with electrolytic capacitor (22 μF) and resistor (600 Ω).	MOV	5.0	2.5	2.5	2.5	–	2.5
Output noise Music mode	NO _{MUS}	NO _{MUS} : Voltage of L _{OUT} (Pin 14), R _{OUT} (Pin 12) through DIN/AUDIO filter. L _{IN} (Pin 25), R _{IN} (Pin 26) : Connect to the GND with electrolytic capacitor (22 μF) and resistor (600 Ω).	MUS	5.0	2.5	2.5	2.5	–	2.5
Output noise Simulated mode	NO _{SIM}	NO _{SIM} : Voltage of L _{OUT} (Pin 14), R _{OUT} (Pin 12) through DIN/AUDIO filter. L _{IN} (Pin 25), R _{IN} (Pin 26) : Connect to the GND with electrolytic capacitor (22 μF) and resistor (600 Ω).	SIM	5.0	2.5	2.5	2.5	–	2.5

Note 1. OFF: OFF mode, MOV: Movie mode, MUS: Music mode, SIM: Simulated mode

2. VOL: Volume control voltage, BAL: Balance control voltage, TRE: Treble control voltage, BAS: Bass control voltage, L+R: L+R volume control voltage, EFF: Effect control voltage, –: Undefined

Electrical characteristics measurement: Matrix block (3/5)

Parameter	Symbol	Test conditions	Note 1 Surround mode	Control pin voltage (V) Note 2					
				VOL	BAL	TRE	BAS	L+R	EFF
Crosstalk	CT	$CT = 20 \log \frac{V_{LIN}}{V_{RIN}}$ <p>L-channel V_{LIN} : Voltage of L_{OUT} (Pin 14) V_{RIN} : Voltage of R_{OUT} (Pin 12) L_{IN} (Pin 25) : f = 1 kHz, V_{IN} = 0.5 V_{r.m.s.}, BPF (f = 1 kHz) used R_{IN} (Pin 26) : Connect to the GND with electrolytic capacitor (22 μF) and resistor (600 Ω).</p> <p>R-channel V_{LIN} : Voltage of L_{OUT} (Pin 14) V_{RIN} : Voltage of R_{OUT} (Pin 12) R_{IN} (Pin 26) : f = 1 kHz, V_{IN} = 0.5 V_{r.m.s.}, BPF (f = 1 kHz) used L_{IN} (Pin 25) : Connect to the GND with electrolytic capacitor (22 μF) and resistor (600 Ω).</p>	OFF	5.0	2.5	2.5	2.5	–	–

Note 1. OFF: OFF mode

- 2.** VOL: Volume control voltage, BAL: Balance control voltage, TRE: Treble control voltage, BAS: Bass control voltage, L+R: L+R volume control voltage, EFF: Effect control voltage, –: Undefined

Electrical characteristics measurement: Matrix block (4/5)

Parameter	Symbol	Test conditions
Inter-mode offset	V _{OSM}	<p>(OFF : OFF mode, MUS : Music mode, MOV : Movie mode, SIM : Simulated mode)</p> <p>V_{OSM} (OFF→MUS) : Difference between V_{DC} (OFF) and V_{DC} (MUS). V_{DC} (OFF) : DC voltage of L_{OUT} (Pin 14). (OFF) V_{DC} (MUS) : DC voltage of L_{OUT} (Pin 14). (MUS)</p> <p>V_{OSM} (OFF→MOV) : Difference between V_{DC} (OFF) and V_{DC} (MOV). V_{DC} (OFF) : DC voltage of L_{OUT} (Pin 14). (OFF) V_{DC} (MOV) : DC voltage of L_{OUT} (Pin 14). (MOV)</p> <p>V_{OSM} (OFF→SIM) : Difference between V_{DC} (OFF) and V_{DC} (SIM). V_{DC} (OFF) : DC voltage of L_{OUT} (Pin 14). (OFF) V_{DC} (SIM) : DC voltage of L_{OUT} (Pin 14). (SIM)</p> <p>V_{OSM} (SIM→MUS) : Difference between V_{DC} (SIM) and V_{DC} (MUS). V_{DC} (SIM) : DC voltage of L_{OUT} (Pin 14). (SIM) V_{DC} (MUS) : DC voltage of L_{OUT} (Pin 14). (MUS)</p> <p>V_{OSM} (SIM→MOV) : Difference between V_{DC} (SIM) and V_{DC} (MOV). V_{DC} (SIM) : DC voltage of L_{OUT} (Pin 14). (SIM) V_{DC} (MOV) : DC voltage of L_{OUT} (Pin 14). (MOV)</p> <p>V_{OSM} (MUS→MOV) : Difference between V_{DC} (MUS) and V_{DC} (MOV). V_{DC} (MUS) : DC voltage of L_{OUT} (Pin 14). (MUS) V_{DC} (MOV) : DC voltage of L_{OUT} (Pin 14). (MOV)</p> <p>Execute the same operation for R_{out} (Pin 12).</p>

Electrical characteristics measurement: Matrix block (5/5)

Parameter	Symbol	Test conditions	Surround mode
DC offset 1	V _{DCOS1}	$V_{DCOS1} = V_{VOLH} - V_{VOLL}$ V _{VOLH} : Voltage of L _{out} (Pin 14), R _{out} (Pin 12) (Volume control voltage = 5 V) V _{VOLL} : Voltage of L _{out} (Pin 14), R _{out} (Pin 12) (Volume control voltage = 0 V)	OFF
DC offset 2	V _{DCOS2}	$V_{DCOS2} = V_{L+RH} - V_{L+RL}$ V _{L+RH} : Voltage of L+R _{out} (Pin 13). (L+R volume control voltage = 5 V) V _{L+RL} : Voltage of L+R _{out} (Pin 13). (L+R volume control voltage = 0 V)	OFF
DC offset 3	V _{DCOS3}	$V_{DCOS3} = V_{BALM} - V_{BALL}$ V _{BALM} : Voltage of L _{out} (Pin 14), R _{out} (Pin 12) (Balance control voltage = 2.5 V) V _{BALL} : Voltage of L _{out} (Pin 14), R _{out} (Pin 12) (Balance control voltage = 0 V) $V_{DCOS3} = V_{BALM} - V_{BALH}$ V _{BALM} : Voltage of L _{out} (Pin 14), R _{out} (Pin 12) (Balance control voltage = 2.5 V) V _{BALH} : Voltage of L _{out} (Pin 14), R _{out} (Pin 12) (Balance control voltage = 5 V)	OFF
DC offset 4	V _{DCOS4}	$V_{DCOS4} = V_{BASM} - V_{BASL}$ V _{BASM} : Voltage of L _{out} (Pin 14), R _{out} (Pin 12) (Bass control voltage = 2.5 V) V _{BASL} : Voltage of L _{out} (Pin 14), R _{out} (Pin 12) (Bass control voltage = 0 V) $V_{DCOS4} = V_{BASM} - V_{BASH}$ V _{BASM} : Voltage of L _{out} (Pin 14), R _{out} (Pin 12) (Bass control voltage = 2.5 V) V _{BASH} : Voltage of L _{out} (Pin 14), R _{out} (Pin 12) (Bass control voltage = 5 V)	OFF
DC offset 5	V _{DCOS5}	$V_{DCOS5} = V_{TREM} - V_{TREL}$ V _{TREM} : Voltage of L _{out} (Pin 14), R _{out} (Pin 12) (Treble control voltage = 2.5 V) V _{TREL} : Voltage of L _{out} (Pin 14), R _{out} (Pin 12) (Treble control voltage = 0 V) $V_{DCOS5} = V_{TREM} - V_{TREH}$ V _{TREM} : Voltage of L _{out} (Pin 14), R _{out} (Pin 12) (Treble control voltage = 2.5 V) V _{TREH} : Voltage of L _{out} (Pin 14), R _{out} (Pin 12) (Treble control voltage = 5 V)	OFF

Note OFF: OFF mode

FREQUENCY RESPONSE CHARACTERISTICS IN EACH MODE (at T_A = 25 °C)

1. OFF Mode (L-ch, R-ch)

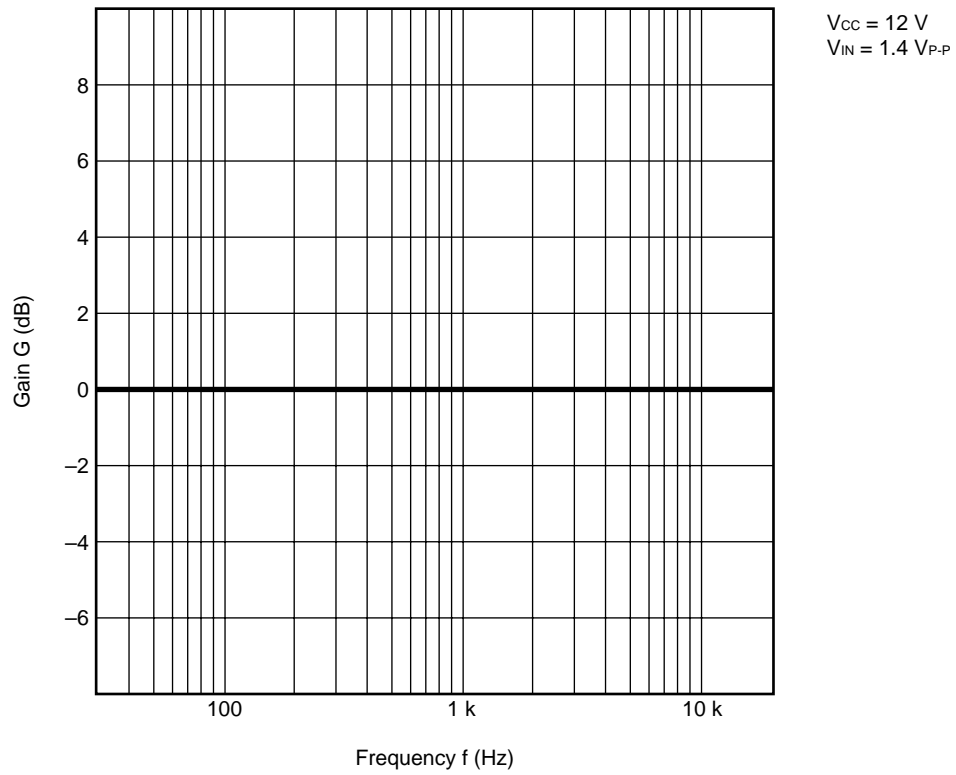

2. Movie Mode

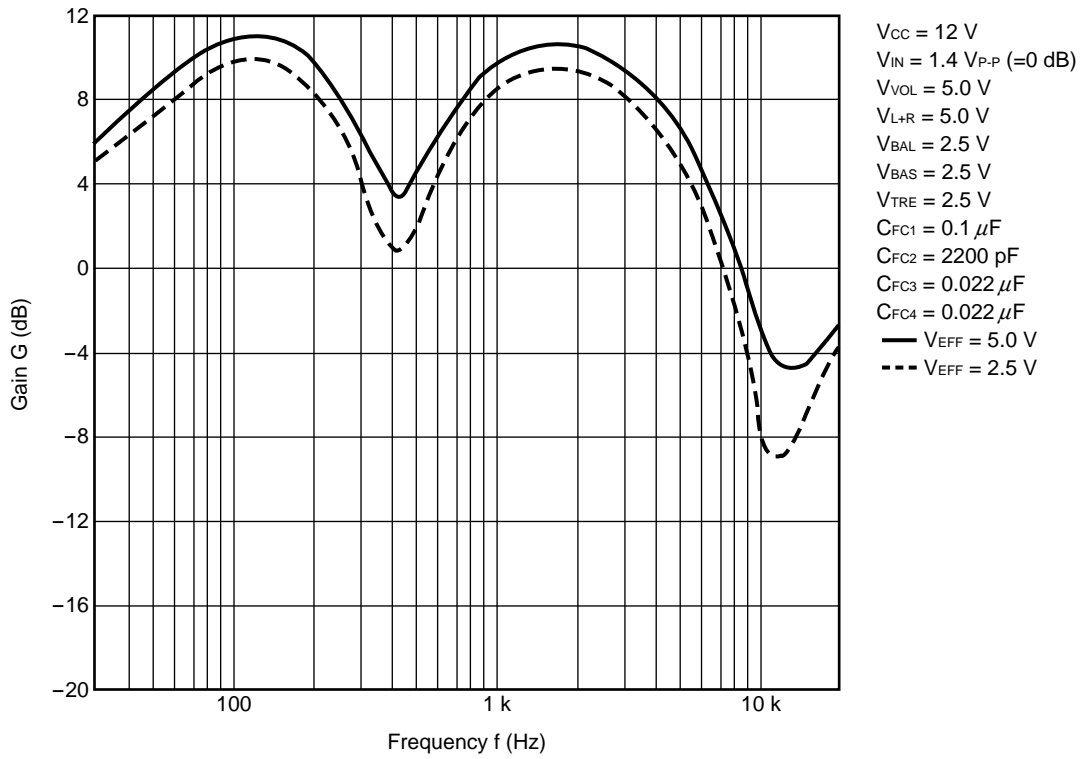

3. Music Mode

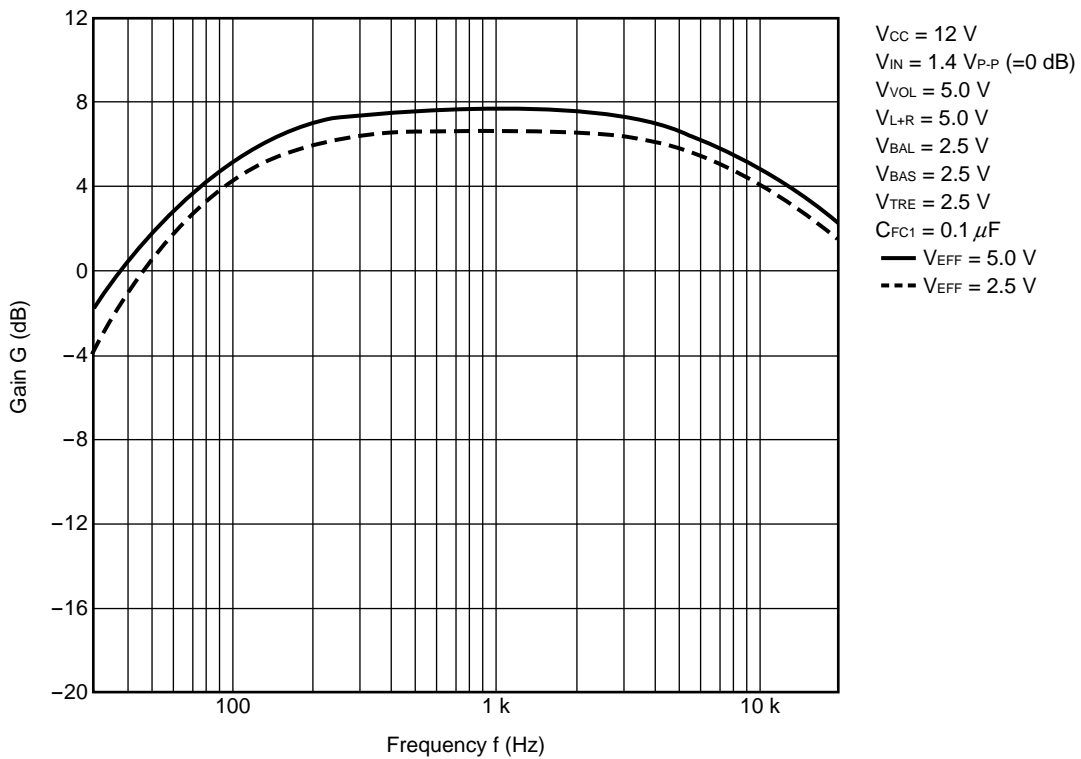

Remark V_{VOL} : Volume control voltage, V_{BAL} : Balance control voltage, V_{BAS} : Bass control voltage, V_{TRE} : Treble control voltage, V_{EFF} : Effect control voltage, V_{L+R} : L+R volume control voltage, C_{FC1} , C_{FC2} , C_{FC3} , C_{FC4} : External capacitance connected to FC1 to FC4 (Pin 2 to 5).

4. Simulated Mode (L-ch)

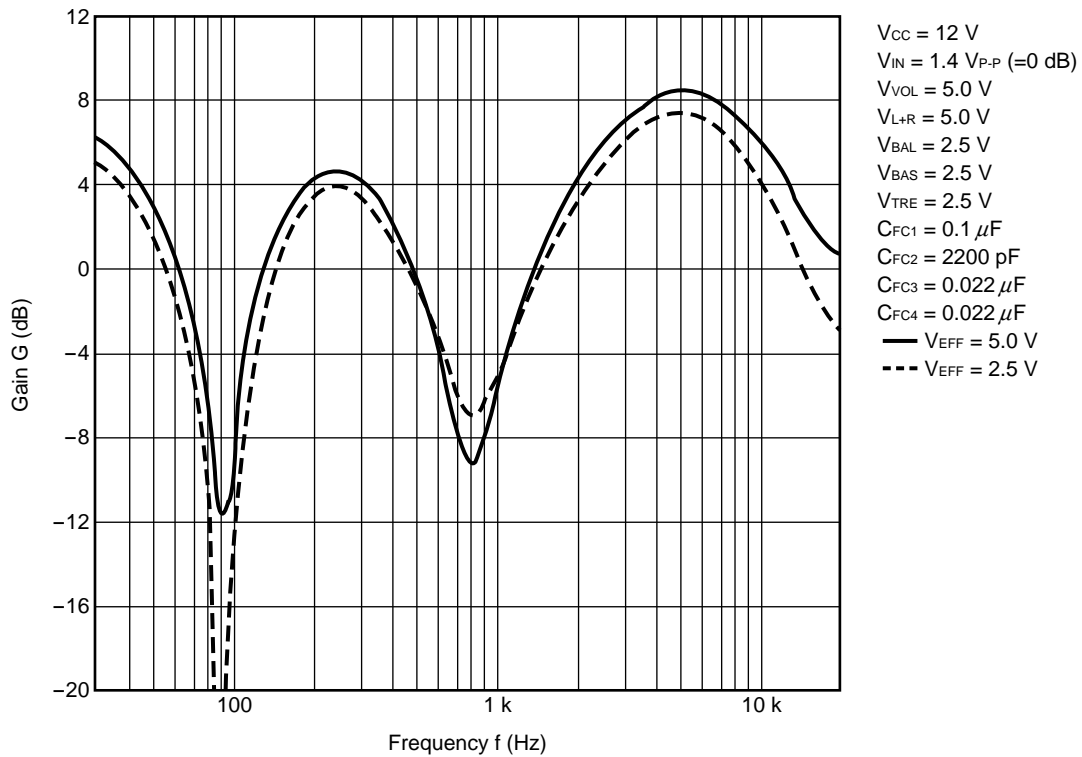

5. Simulated Mode (R-ch)

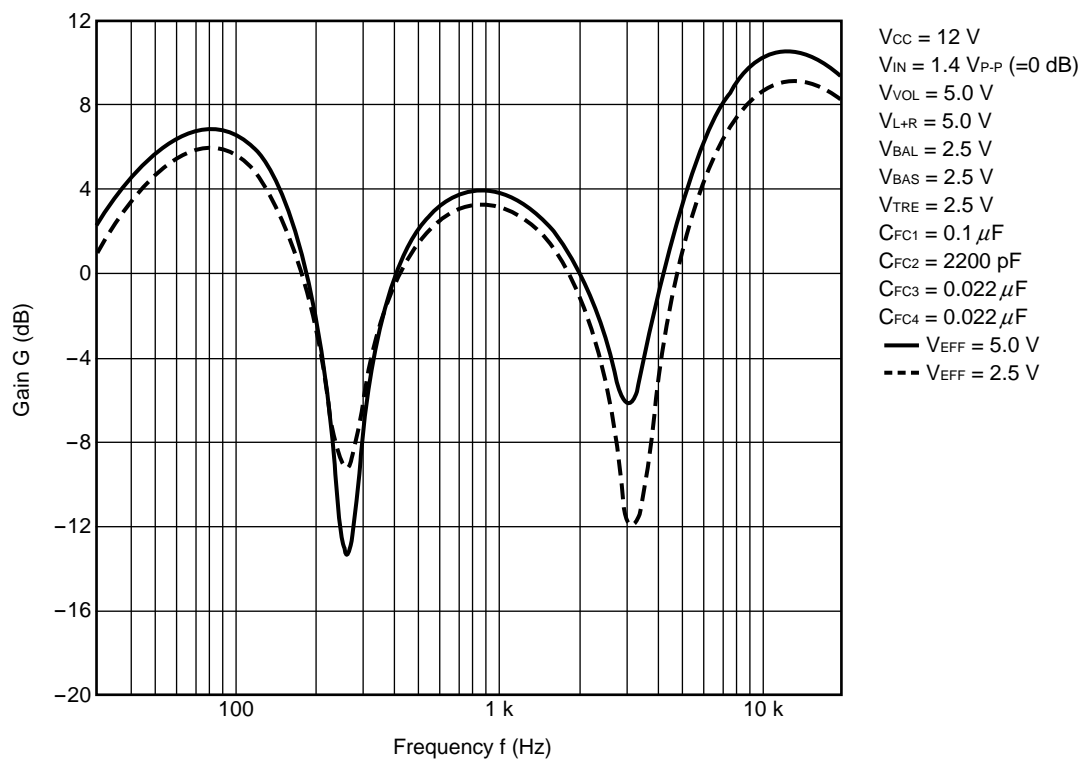

Remark V_{VOL} : Volume control voltage, V_{BAL} : Balance control voltage, V_{BAS} : Bass control voltage, V_{TRE} : Treble control voltage, V_{EFF} : Effect control voltage, V_{L+R} : L+R volume control voltage, C_{FC1} , C_{FC2} , C_{FC3} , C_{FC4} : External capacitance connected to FC1 to FC4 (Pin 2 to 5).

CHARACTERISTICS OF PHASE SHIFTER AND REAR OUTPUT (at T_A = 25 °C)

2. Movie Mode

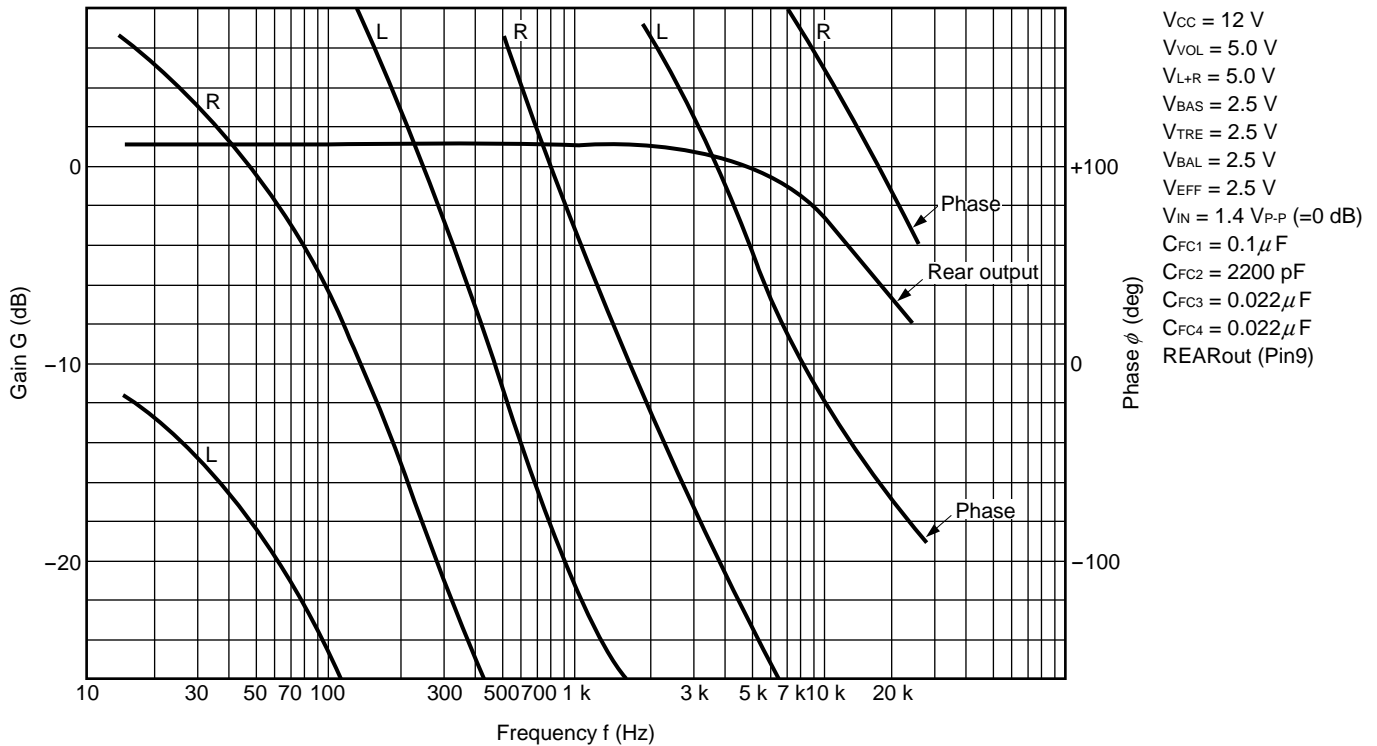

3. Music Mode

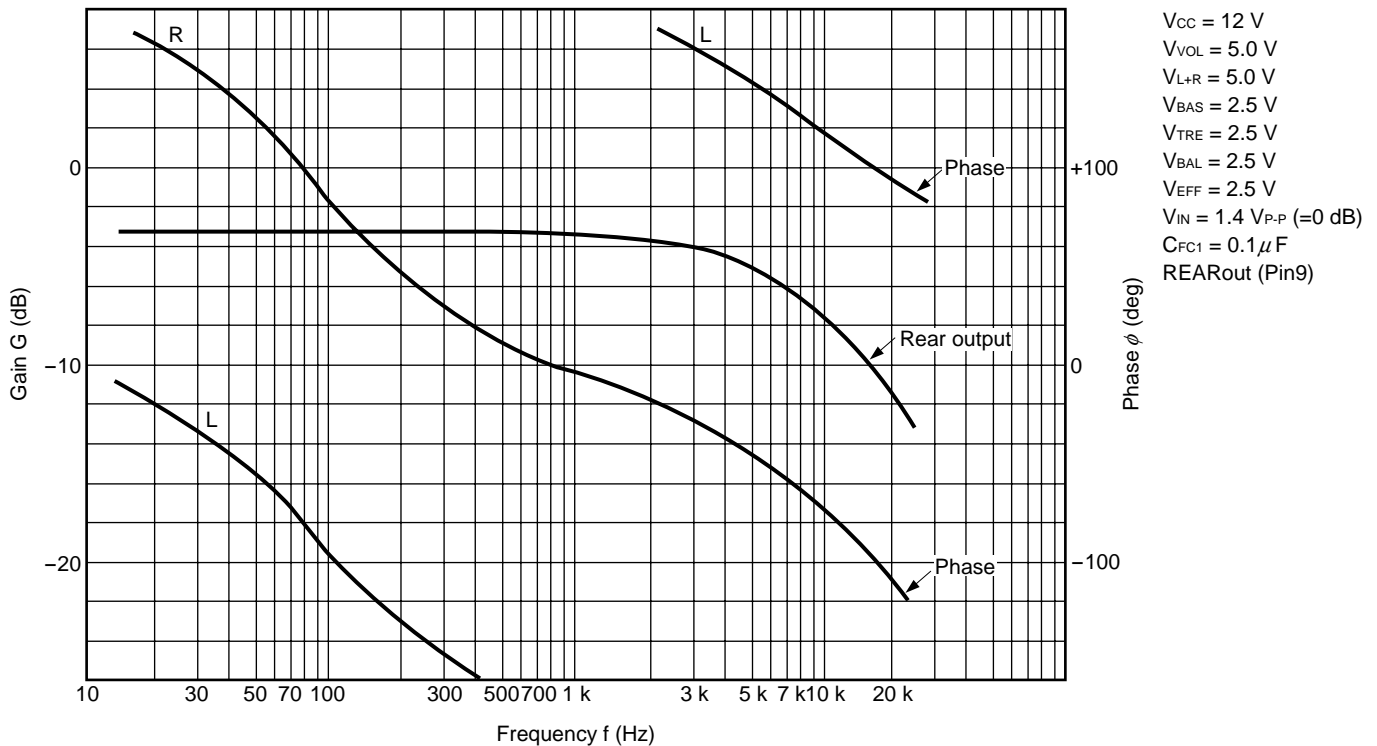

Remark V_{VOL} : Volume control voltage, V_{L+R} : L+R volume control voltage, V_{BAS} : Bass control voltage, V_{TRE} : Treble control voltage, V_{BAL} : Balance control voltage, V_{EFF} : Effect control voltage, C_{FC1} , C_{FC2} , C_{FC3} , C_{FC4} : External capacitance connected to FC1 to FC4 (Pin 2 to 5).

3. Simulated Mode

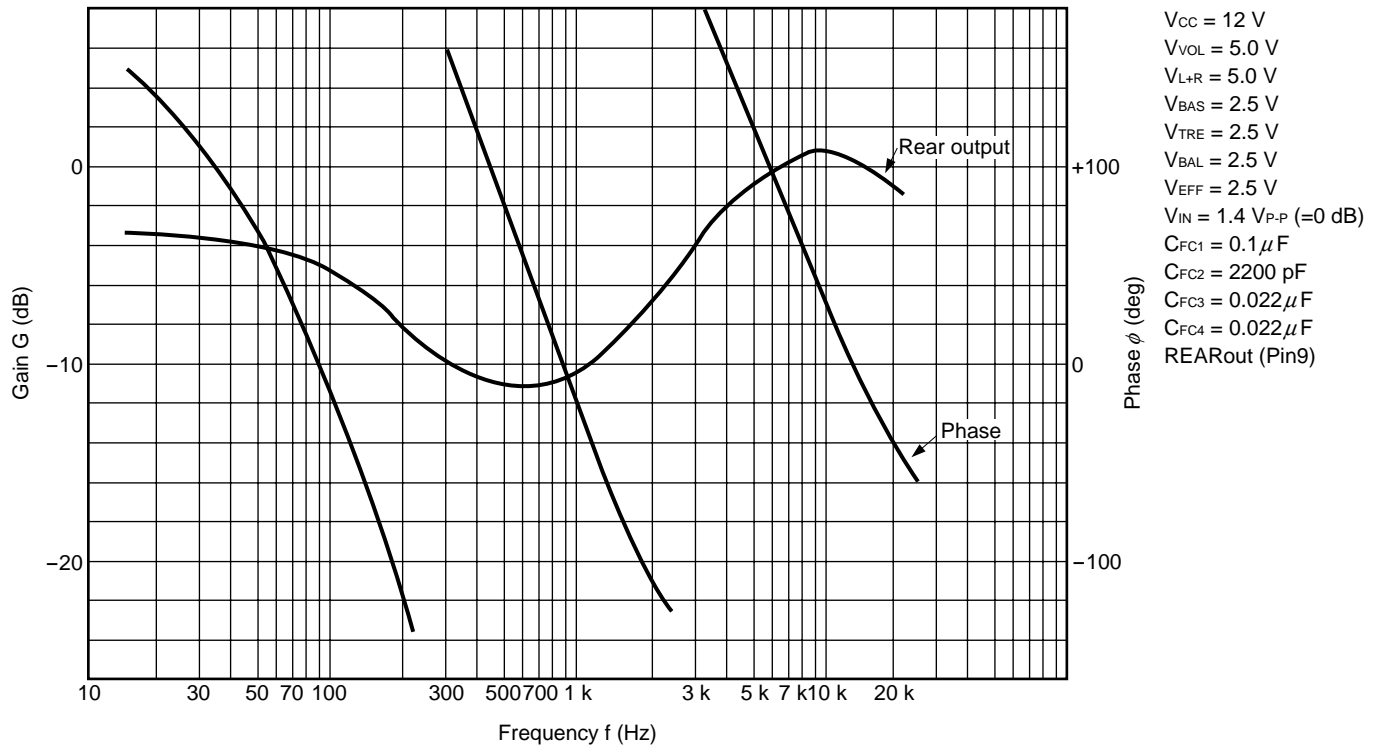

Remark V_{VOL} : Volume control voltage, V_{L+R} : L+R volume control voltage, V_{BAS} : Bass control voltage, V_{TRE} : Treble control voltage, V_{BAL} : Balance control voltage, V_{EFF} : Effect control voltage, C_{FC1} , C_{FC2} , C_{FC3} , C_{FC4} : External capacitance connected to FC1 to FC4 (Pin 2 to 5).

CONTROL CHARACTERISTICS

1. Volume Control Characteristics (Lch, Rch)

(1) μPC1892CT

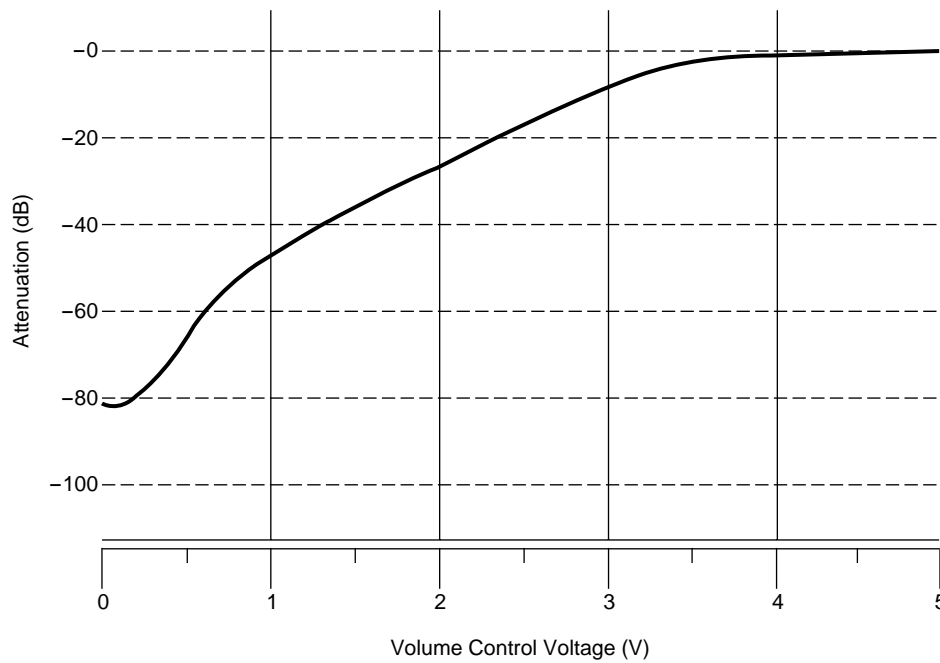

OFF mode
 f = 1 kHz
 $V_{IN} = 1.4 V_{P-P}$ (=0 dB)
 $V_{BAS} = 2.5 V$
 $V_{TRE} = 2.5 V$
 $V_{EFF} = 2.5 V$
 $V_{BAL} = 2.5 V$
 $V_T = 2.5 V$
 JIS-A filter used

(2) μPC1892CT-02

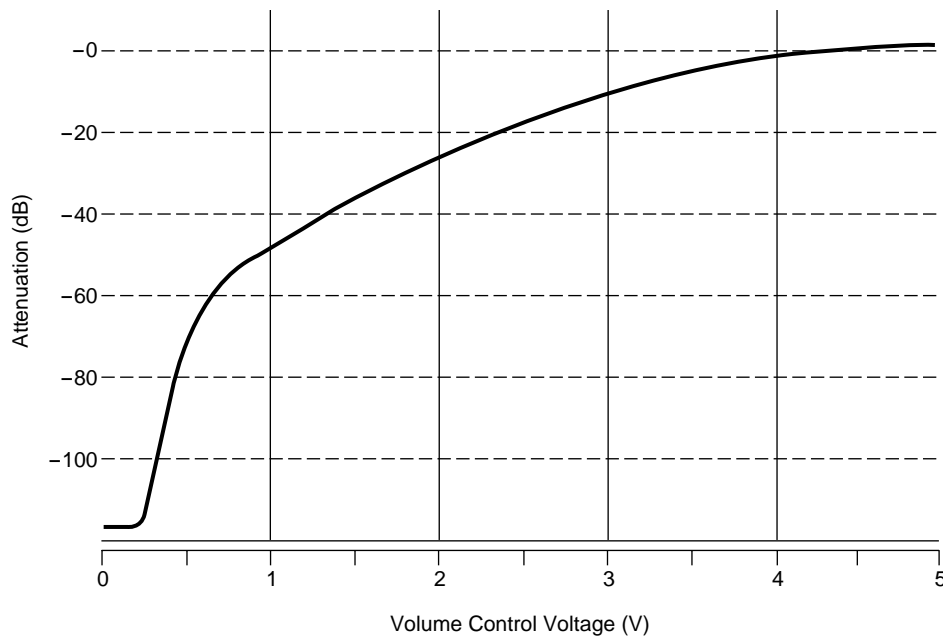

OFF mode
 f = 1 kHz
 $V_{IN} = 1.4 V_{P-P}$ (=0 dB)
 $V_{BAS} = 2.5 V$
 $V_{TRE} = 2.5 V$
 $V_{EFF} = 2.5 V$
 $V_{BAL} = 2.5 V$
 $V_T = 2.5 V$
 JIS-A filter used

Remark V_{LL+R} : L+R volume control voltage, V_{BAS} : Bass control voltage,
 V_{TRE} : Treble control voltage, V_{EFF} : Effect control voltage,
 V_{BAL} : Balance control voltage, V_{VOL} : Volume control voltage,
 V_T : Tone control voltage.

2. Balance Control Characteristics

(1) μ PC1892CT

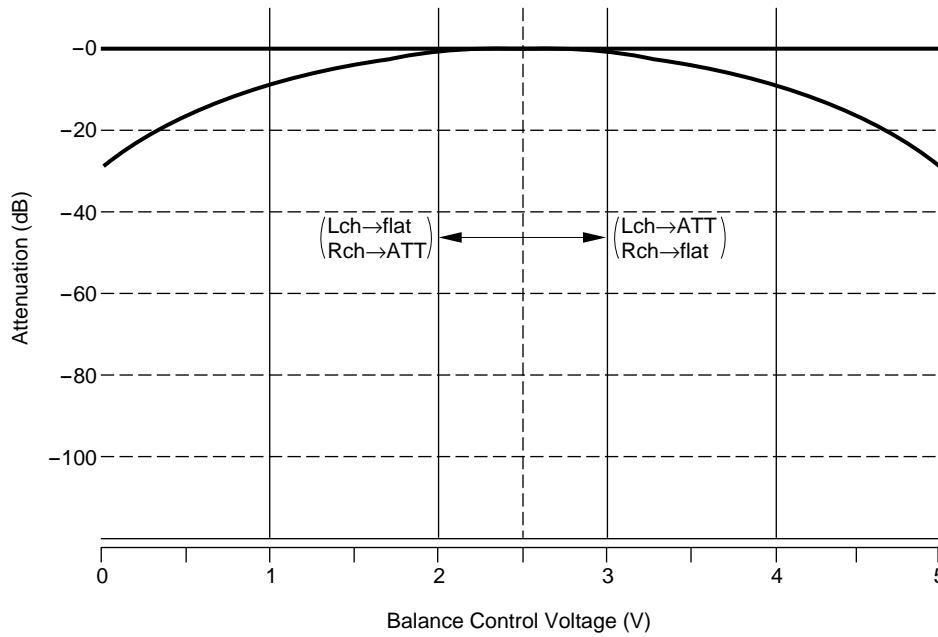

OFF mode
 f = 1 kHz
 $V_{IN} = 1.4 V_{P-P} (=0 \text{ dB})$
 $V_{VOL} = 5.0 \text{ V}$
 $V_{BAS} = 2.5 \text{ V}$
 $V_{TRE} = 2.5 \text{ V}$
 $V_{EFF} = 2.5 \text{ V}$
 $V_T = 2.5 \text{ V}$
 JIS-A filter used

Caution If the control voltage is set to over 5 V, L-channel output level becomes lower.

(2) μ PC1892CT-02

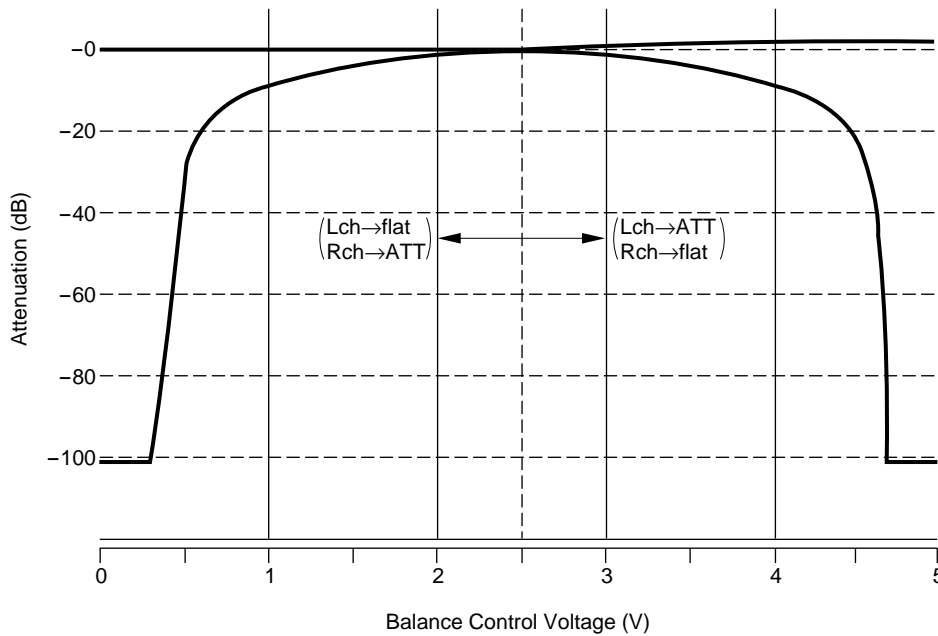

OFF mode
 f = 1 kHz
 $V_{IN} = 1.4 V_{P-P} (=0 \text{ dB})$
 $V_{VOL} = 5.0 \text{ V}$
 $V_{BAS} = 2.5 \text{ V}$
 $V_{TRE} = 2.5 \text{ V}$
 $V_{EFF} = 2.5 \text{ V}$
 $V_T = 2.5 \text{ V}$
 JIS-A filter used

Remark V_{L+R} : L+R volume control voltage, V_{BAS} : Bass control voltage, V_{TRE} : Treble control voltage, V_{EFF} : Effect control voltage, V_{BAL} : Balance control voltage, V_{VOL} : Volume control voltage, V_T : Tone control voltage.

3. Tone Control Characteristics

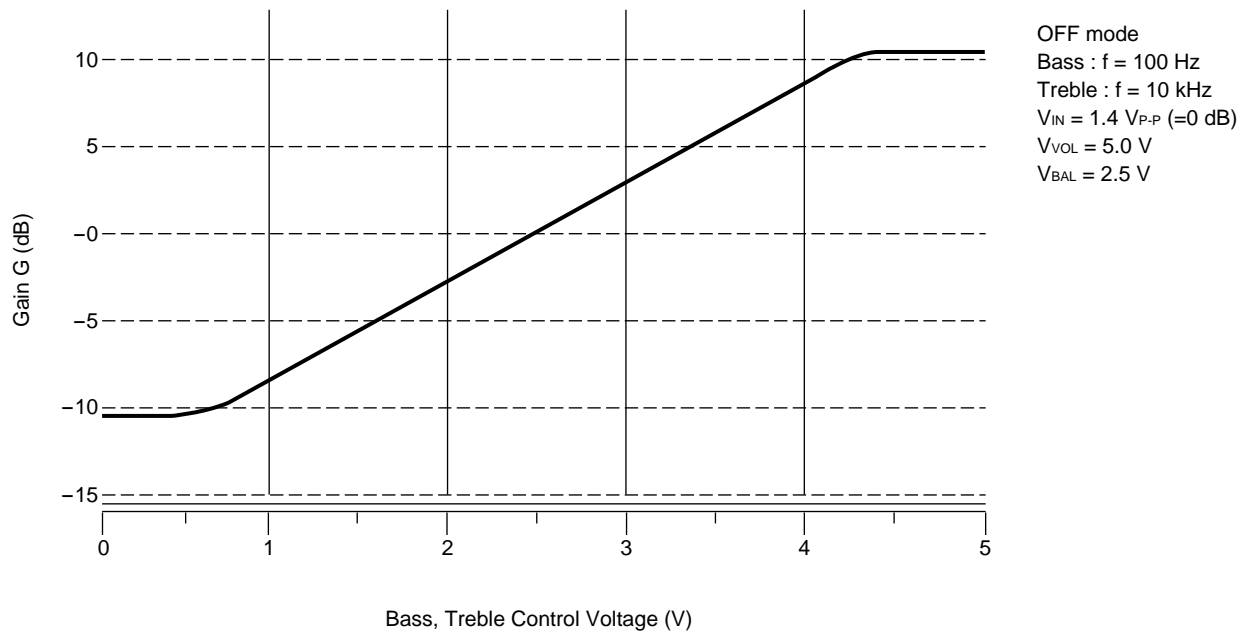

4. Tone Frequency Characteristics

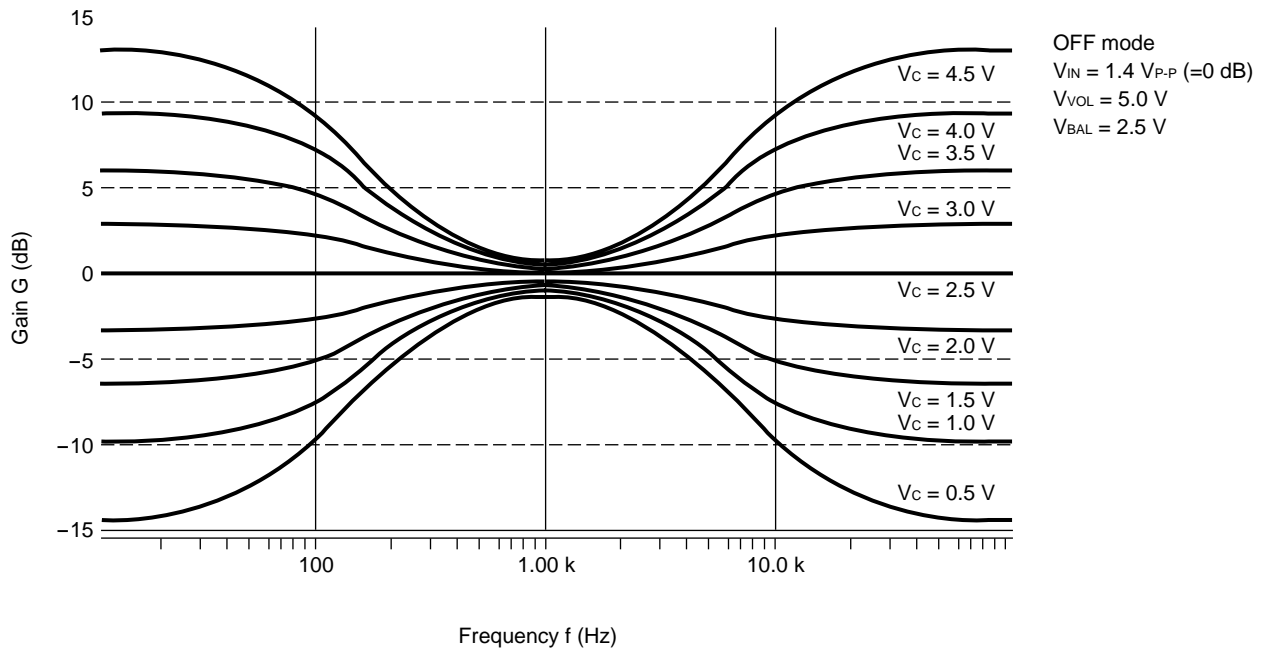

Remark V_{BAL} : Balance control voltage, V_{VOL} : Volume control voltage, V_c : Bass, Treble control voltage.

5. Effect Control Voltage

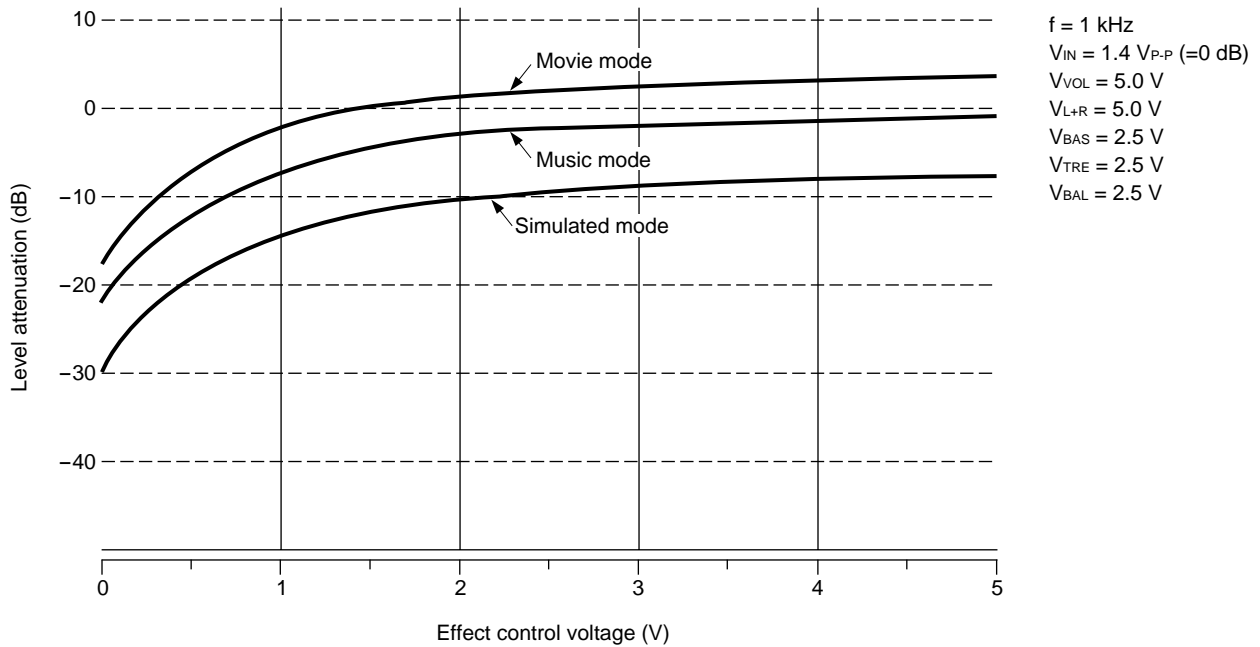

Remark V_{VOL} : Volume control voltage, V_{L+R} : L+R volume control voltage, V_{BAS} : Bass control voltage, V_{TRE} : Treble control voltage, V_{BAL} : Balance control voltage.

INPUT/OUTPUT CHARACTERISTICS, DISTORTION FACTOR

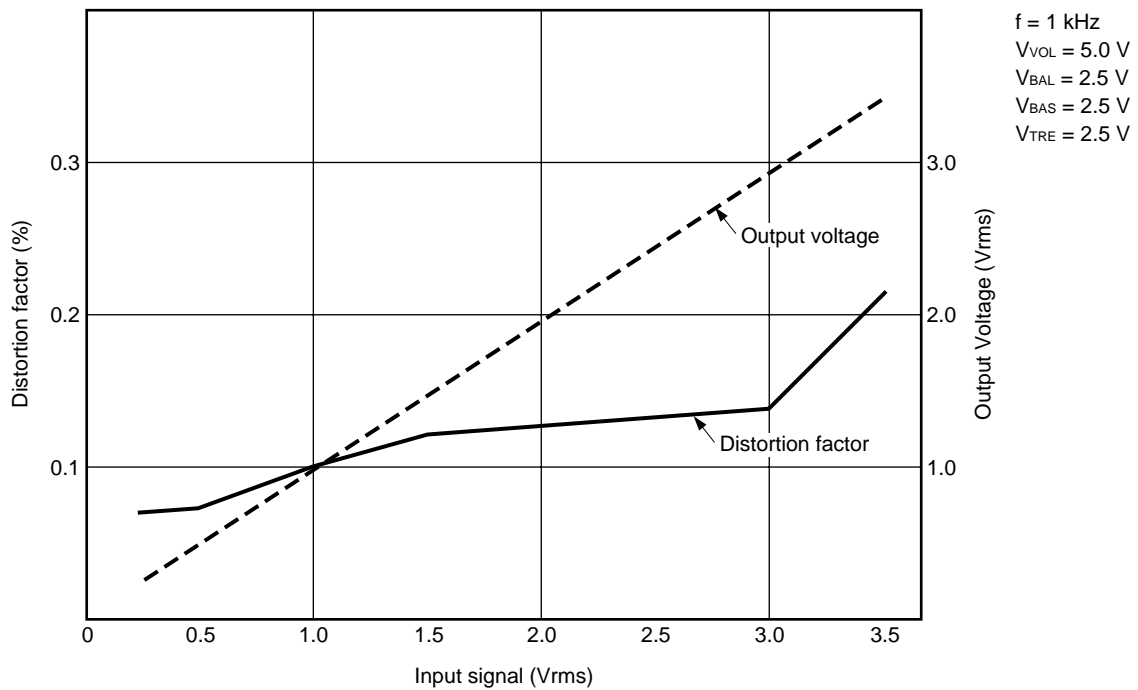

Remark V_{VOL} : Volume control voltage, V_{BAL} : Balance control voltage, V_{BAS} : Bass control voltage, V_{TRE} : Treble control voltage.

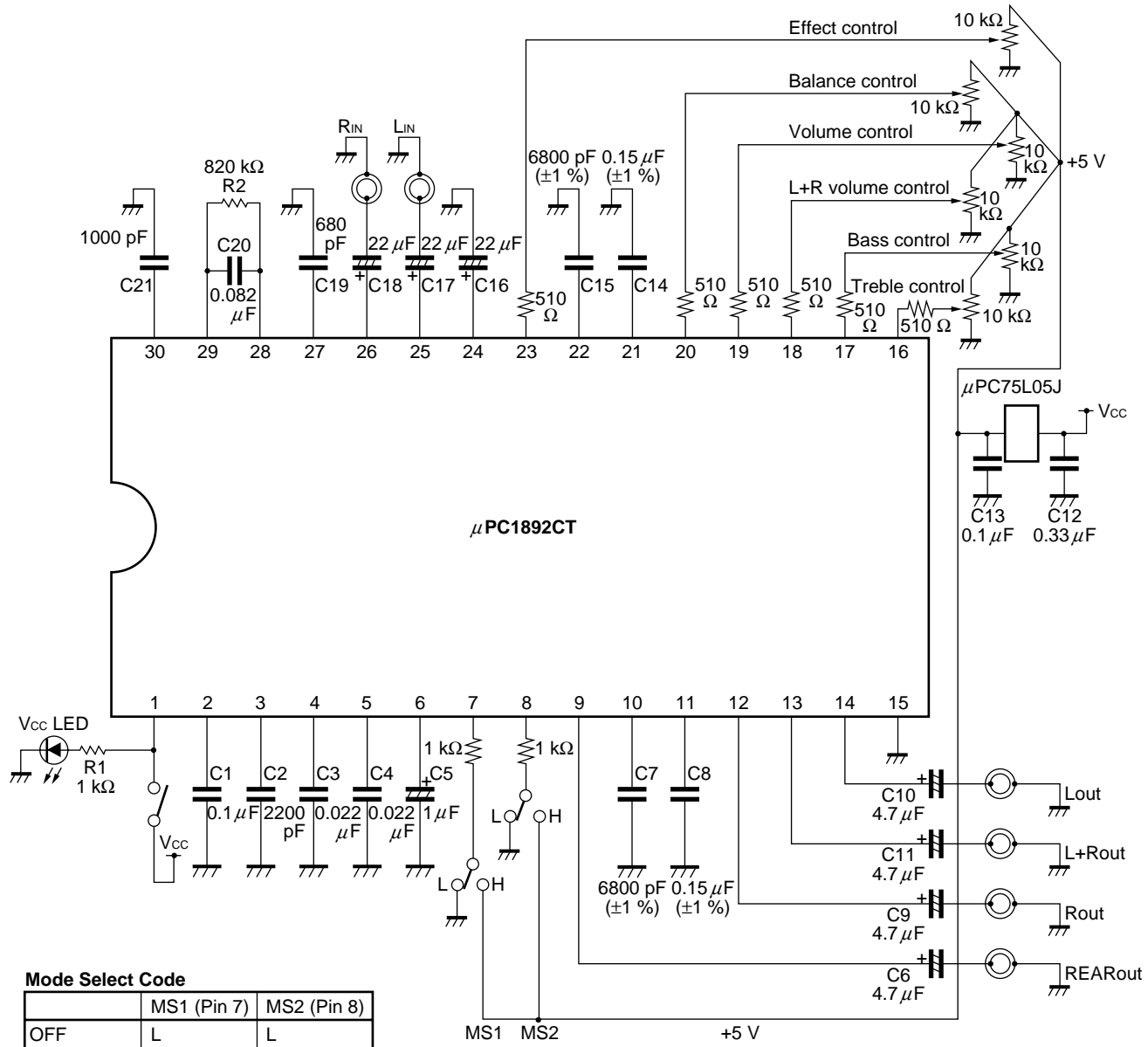

Mode Select Code

	MS1 (Pin 7)	MS2 (Pin 8)
OFF	L	L
Music	H	L
Movie	L	H
Simulated	H	H

PACKAGE DIMENSIONS

30PIN PLASTIC SHRINK DIP (400 mil)

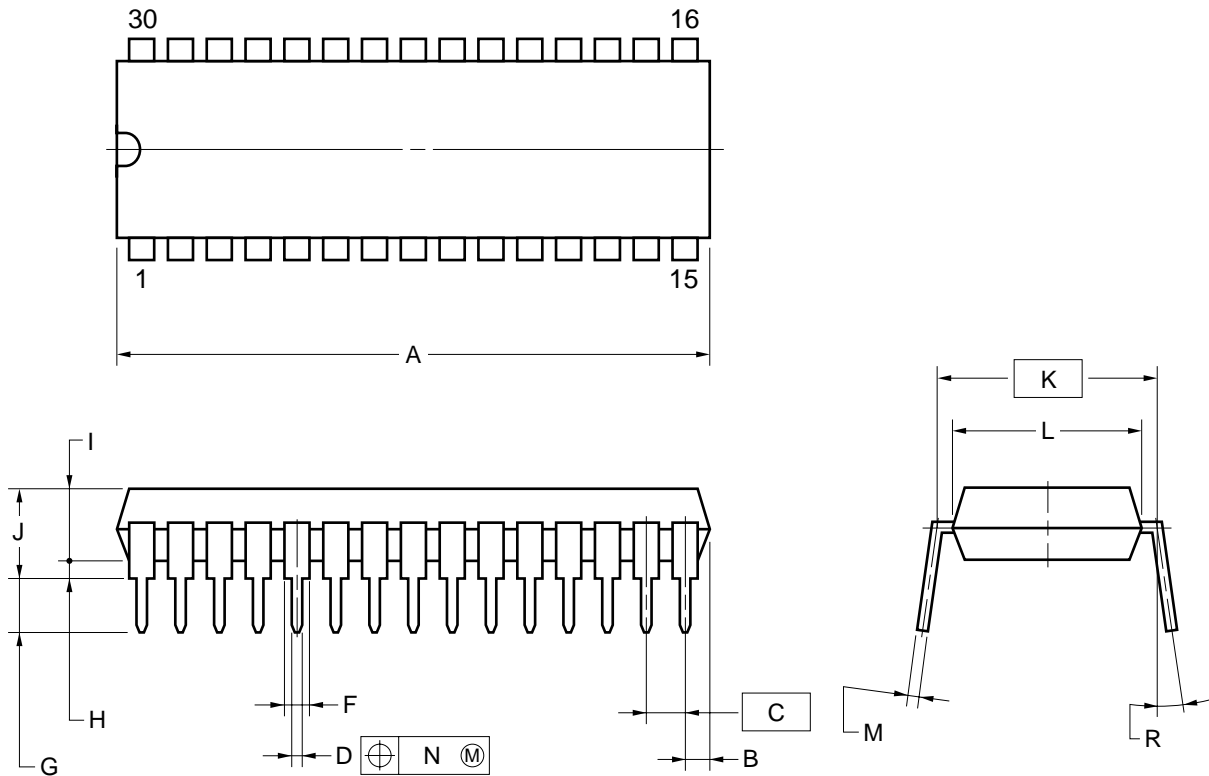

NOTES

- 1) Each lead centerline is located within 0.17 mm (0.007 inch) of its true position (T.P.) at maximum material condition.
- 2) Item "K" to center of leads when formed parallel.

ITEM	MILLIMETERS	INCHES
A	28.46 MAX.	1.121 MAX.
B	1.78 MAX.	0.070 MAX.
C	1.778 (T.P.)	0.070 (T.P.)
D	0.50±0.10	0.020 ^{+0.004} _{-0.005}
F	0.85 MIN.	0.033 MIN.
G	3.2±0.3	0.126±0.012
H	0.51 MIN.	0.020 MIN.
I	4.31 MAX.	0.170 MAX.
J	5.08 MAX.	0.200 MAX.
K	10.16 (T.P.)	0.400 (T.P.)
L	8.6	0.339
M	0.25 ^{+0.10} _{-0.05}	0.010 ^{+0.004} _{-0.003}
N	0.17	0.007
R	0~15°	0~15°

S30C-70-400B-1

RECOMMENDED SOLDERING CONDITIONS

The following conditions (see table below) must be met when soldering this product.

For more details, refer to our document "**SEMICONDUCTOR DEVICE MOUNTING TECHNOLOGY MANUAL**" (IEI-1207).

Please consult with our sales offices in case other soldering process is used, or in case soldering is done under different conditions.

Type of Through Hole Device

μPC1892CT : 30-pin plastic shrink DIP (400 mil)

μPC1892CT-02 : 30-pin plastic shrink DIP (400 mil)

Soldering Process	Soldering Conditions
Wave Soldering (For leads only)	Solder temperature: 260 °C or lower. Flow time: 10 seconds or less.
Partial Heating Method	Pin temperature: 260 °C or lower. Time: 10 seconds or less.

Caution Do not jet molten solder on the surface of package.

[MEMO]

[MEMO]

The application circuits and their parameters are for references only and are not intended for use in actual design-in's.

No part of this document may be copied or reproduced in any form or by any means without the prior written consent of NEC Corporation. NEC Corporation assumes no responsibility for any errors which may appear in this document.

NEC Corporation does not assume any liability for infringement of patents, copyrights or other intellectual property rights of third parties by or arising from use of a device described herein or any other liability arising from use of such device. No license, either express, implied or otherwise, is granted under any patents, copyrights or other intellectual property rights of NEC Corporation or others.

While NEC Corporation has been making continuous effort to enhance the reliability of its semiconductor devices, the possibility of defects cannot be eliminated entirely. To minimize risks of damage or injury to persons or property arising from a defect in an NEC semiconductor device, customer must incorporate sufficient safety measures in its design, such as redundancy, fire-containment, and anti-failure features.

NEC devices are classified into the following three quality grades:

“Standard”, “Special”, and “Specific”. The Specific quality grade applies only to devices developed based on a customer designated “quality assurance program” for a specific application. The recommended applications of a device depend on its quality grade, as indicated below. Customers must check the quality grade of each device before using it in a particular application.

Standard: Computers, office equipment, communications equipment, test and measurement equipment, audio and visual equipment, home electronic appliances, machine tools, personal electronic equipment and industrial robots

Special: Transportation equipment (automobiles, trains, ships, etc.), traffic control systems, anti-disaster systems, anti-crime systems, safety equipment and medical equipment (not specifically designed for life support)

Specific: Aircrafts, aerospace equipment, submersible repeaters, nuclear reactor control systems, life support systems or medical equipment for life support, etc.

The quality grade of NEC devices in “Standard” unless otherwise specified in NEC's Data Sheets or Data Books. If customers intend to use NEC devices for applications other than those specified for Standard quality grade, they should contact NEC Sales Representative in advance.

Anti-radioactive design is not implemented in this product.