

Rotary Switches

10 x 10 mm Sealed Rotary DIP Switches (THR)

RD83T Series

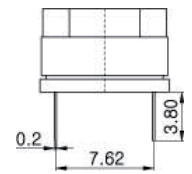
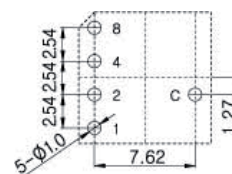
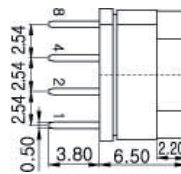
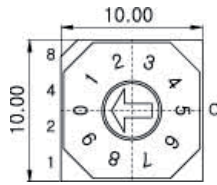

RD83TH THT Top Adjust Type Terminals

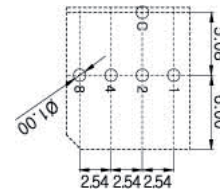
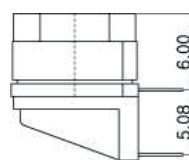
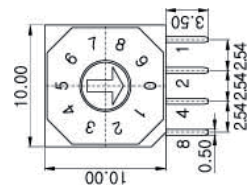

RD83TA1 THT Angel Type (5.08) Terminals

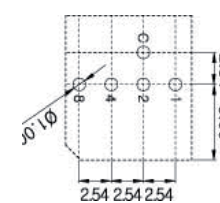
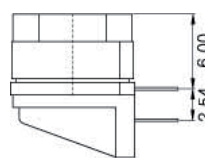
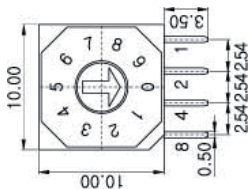

RD83TA2 THT Angel Type (2.54) Terminals

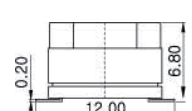
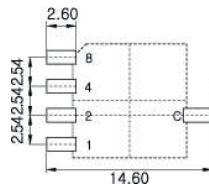
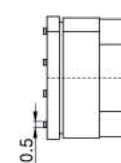
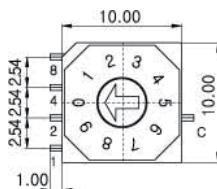

RD83TS SMT Top Type Terminals

How to order:

RD83T

1 TYPE OF TERMINALS:

- H THT Top Adjust Type
- A1 THT Angel Type (5.08)
- A2 THT Angel Type (2.54)
- S SMT Top Type

2 ROTOR TYPE (See Above Drawings):

- S1 Arrow Type
- S2 Shaft Type
- S3 Cross Type

3 NO. OF POSITIONS:

- 04 04 Positions
- 06 06 Positions
- 08 08 Positions
- 10 10 Positions
- 16 16 Positions

4 CODE:

- R Real Code
- S Complementary Code

5 PACKAGING TYPE:

- TB Tube
- TR Tape & Reel (RD83S Only)

General Specifications:

FEATURES

- » Sealing: IP 67(Dust & Waterproof)
- » THR (Thru Hole Reflow solderable)

MECHANICAL

- » Life Cycle: 10,000 steps
- » Operating Force: 700 gf max.

ELECTRICAL

- » Contact Rating: 150mA, 24V (Switching)
400mA, 24V (None-Switching)
- » Contact Resistance: 80mΩ Max
- » Insulation Resistance: 100MΩ Min
- » Solder Condition: Solder reflow max: 10s/260°C
Solder iron max: 4s./350°C
Solder bath max: 5s/280°C

PACKING

- » Tube: 50pcs / Tube
- » Reel: 600pcs / Reel

Rotary Switches

10 x 10 mm Sealed Rotary DIP Switches (THR)

RD83T Series

ROTOR TYPE

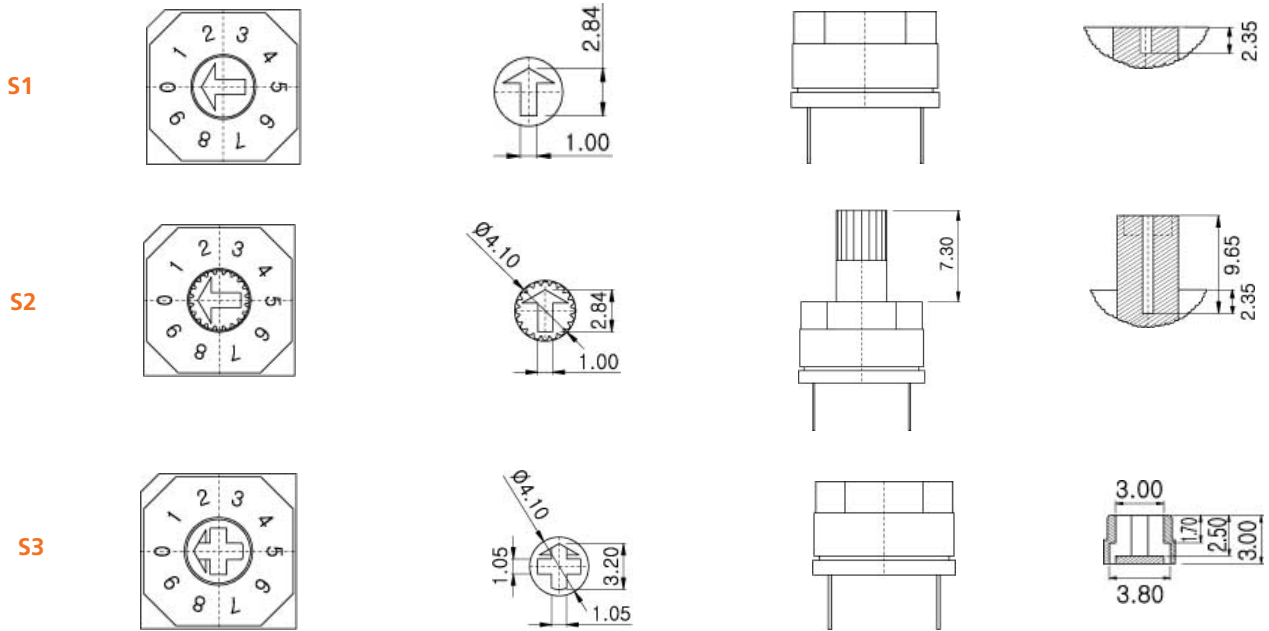

CODE

Real Code

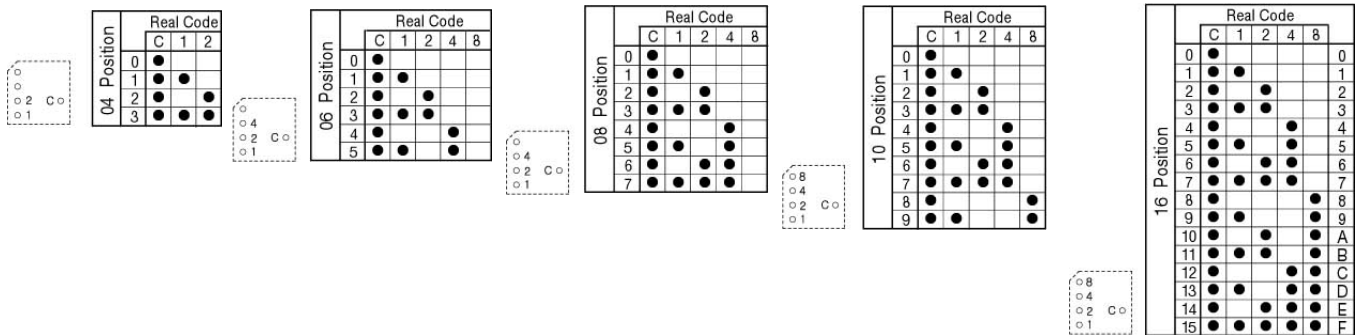

Complement Code

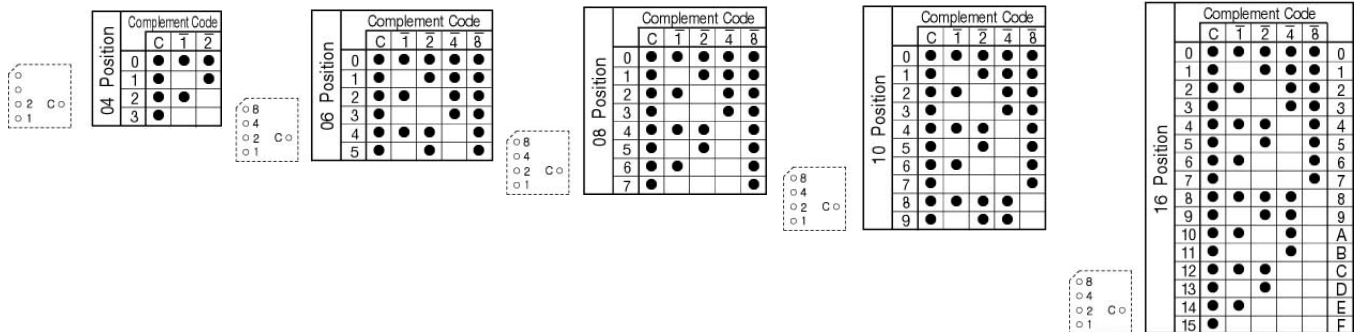

ACCESSORIES

