

**Technical Data Sheet**

**Full Color Top LEDs**

**67-23/R6GHBHC-B05/2T**

**Features**

- P-LCC-4 package.
- White package.
- Optical indicator.
- Colorless clear window.
- Pb-free.
- The product itself will remain within RoHS compliant version.

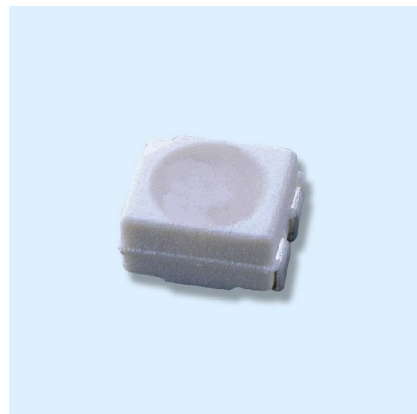

**Descriptions**

- The 67-23 series is available in soft red, green, blue and yellow. Due to the package design, the LED has wide viewing angle and optimized light coupling by inter reflector. This feature makes the ideal for light pipe application. The low current requirement makes this device ideal for portable equipment or any other application where power is at a premium.

**Applications**

- Telecommunication: indicator and backlighting in telephone and fax.
- Flat backlight for LCD's, switches and symbols.
- Light pipe application.
- General use.

**Device Selection Guide**

Chip		Emitted Color	Lens Color
Type	Material		
R6	AlGaInP	Brilliant Red	Water Clear
GH	InGaN	Brilliant Green	
BH	InGaN	Blue	

**Technical Data Sheet**  
**Full Color Top LEDs**

**67-23/R6GHBHC-B05/2T**

**Package Outline Dimensions**

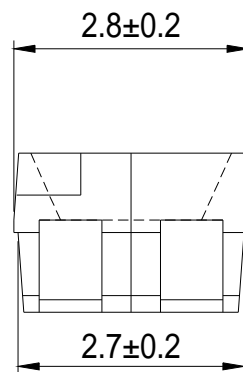
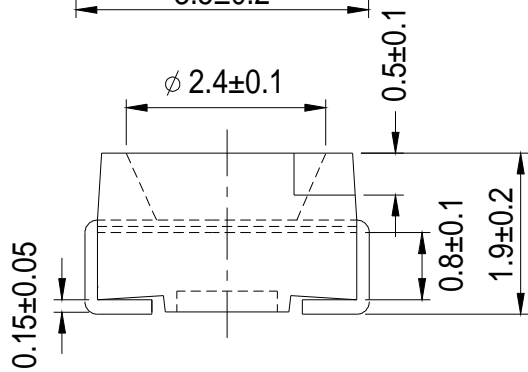
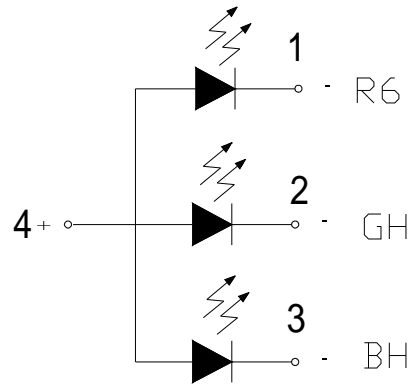
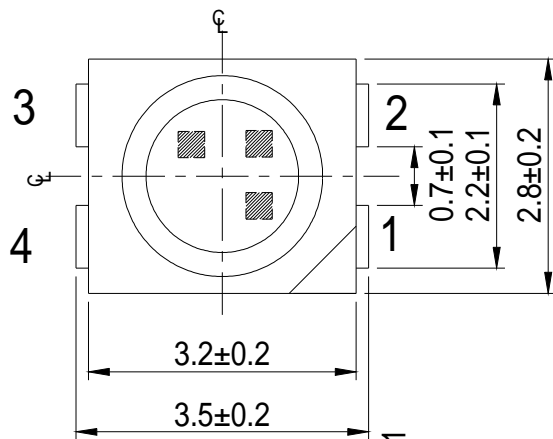

For reflow soldering(propose)

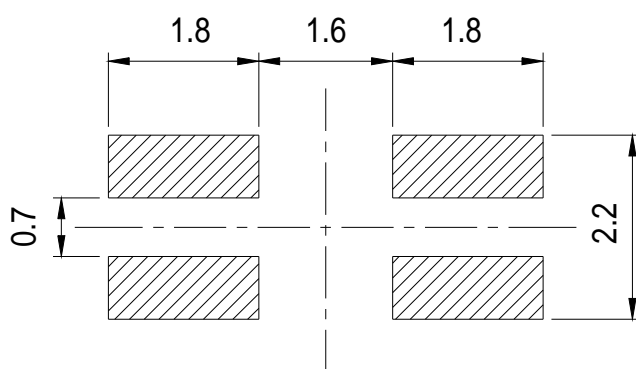
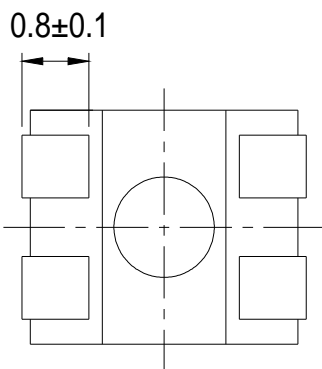

**Notes:** All dimensions are in millimeters.

**Technical Data Sheet**

**Full Color Top LEDs**

**67-23/R6GHBHC-B05/2T**

**Absolute Maximum Ratings (Ta=25 )**

Parameter	Symbol	Rating		Unit
Reverse Voltage	V <sub>R</sub>	5		V
Forward Current	I <sub>F</sub>	R6	25	mA
		GH	25	
		BH	25	
Operating Temperature	T <sub>opr</sub>	-40 ~ +85		
Storage Temperature	T <sub>stg</sub>	-40~ +100		
Electrostatic Discharge(HBM)	ESD	R6	2000	V
		GH	150	
		BH	150	
Power Dissipation	P <sub>d</sub>	R6	120	mW
		GH	110	
		BH	110	
Peak Forward Current(Duty 1/10 @ 1KHz)	I <sub>FP</sub>	R6	100	mA
		GH	100	
		BH	100	
Soldering Temperature	T <sub>sol</sub>	Reflow Soldering : 260 for 10 sec.		
		Hand Soldering : 350 for 3 sec.		

Technical Data Sheet

Full Color Top LEDs

**67-23/R6GHBHC-B05/2T**

Electro-Optical Characteristics (Ta=25 )

Parameter	Symbol	Min.	Typ.	Max.	Unit	Condition	
Luminous Intensity	Iv	R6	112	-----	285	mcd	If=20mA
		GH	180	-----	715		
		BH	72	-----	180		
Peak Wavelength	p	R6	-----	632	-----	nm	If=20mA
		GH	-----	518	-----		
		BH	-----	468	-----		
Dominant Wavelength	d	R6	621	-----	631	nm	If=20mA
		GH	520	-----	530		
		BH	465	-----	475		
Spectrum Radiation Bandwidth		R6	-----	20	-----	nm	If=20mA
		GH	-----	35	-----		
		BH	-----	35	-----		
Forward Voltage	VF	R6	-----	2.0	2.4	V	If=20mA
		GH	-----	3.4	3.95		
		BH	-----	3.4	3.95		
Viewing Angle	2 1/2	-----	120	-----	deg	If=20mA	
Reverse Current	IR	R6	-----	-----	10	μ A	VR=5V
		GH	-----	-----	50		
		BH	-----	-----	50		

Notes:

- 1.Tolerance of Luminous Intensity  $\pm 11\%$
- 2.Tolerance of Dominant Wavelength  $\pm 1$  nm

**Technical Data Sheet**

**Full Color Top LEDs**

**67-23/R6GHBHC-B05/2T**

**Bin Rang of Luminous Intensity**

Chip	Bin	Min	Max	Unit	Condition
R6	R	112	180	mcd	I <sub>F</sub> =20mA
	S	180	285		
GH	S	180	285		
	T	285	450		
	U	450	715		
BH	Q	72	112		
	R	112	180		

**Bin Rang of Dominate Wavelength**

Chip	Bin	Min	Max	Unit	Condition
R6	FF1	621	626	nm	I <sub>F</sub> =20mA
	FF2	626	631		
GH	X	520	525		
	Y	525	530		
BH	X	465	470		
	Y	470	475		

**Notes:**

- 1.Tolerance of Luminous Intensity  $\pm 11\%$
- 2.Tolerance of Dominant Wavelength  $\pm 1$  nm

**Technical Data Sheet**  
**Full Color Top LEDs**

**67-23/R6GHBHC-B05/2T**

**Typical Electro-Optical Characteristics Curves (R6)**

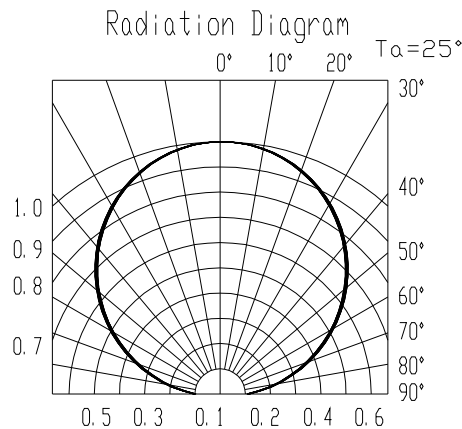
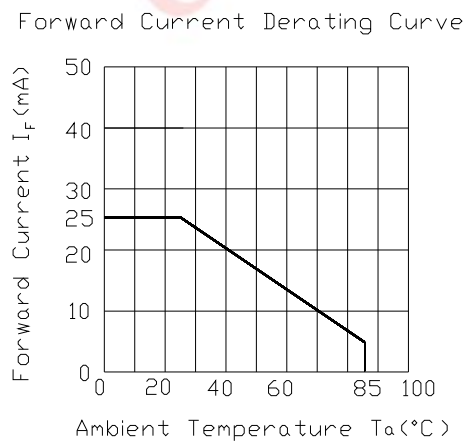
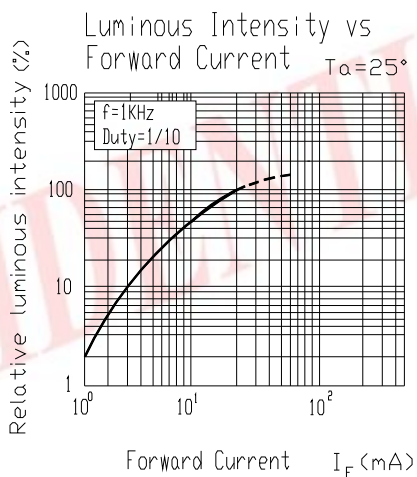
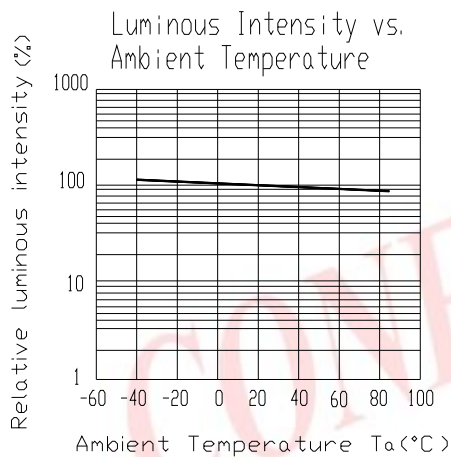
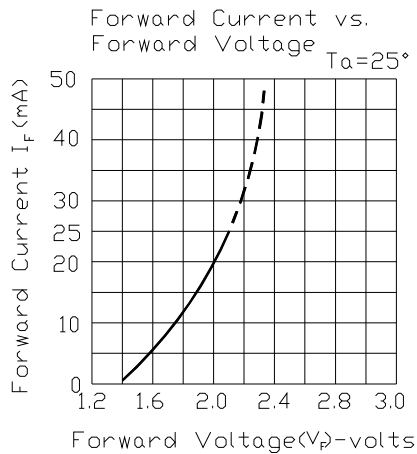
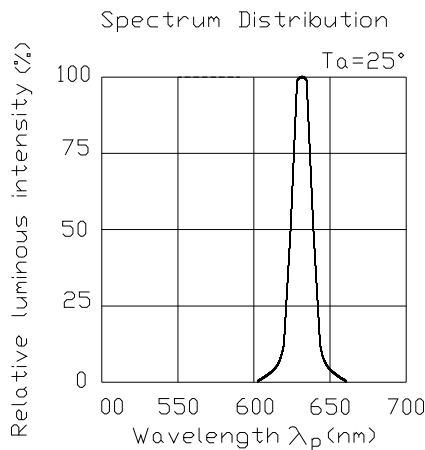

**Technical Data Sheet**  
**Full Color Top LEDs**

**67-23/R6GHBHC-B05/2T**

**Typical Electro-Optical Characteristics Curves (GH)**

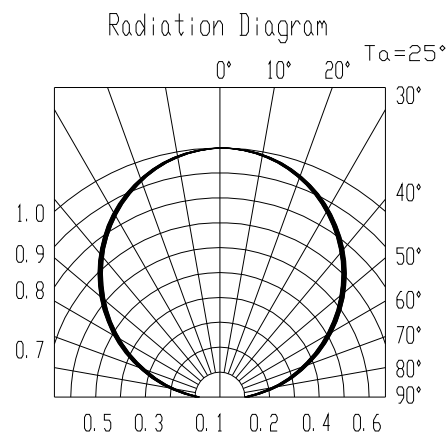
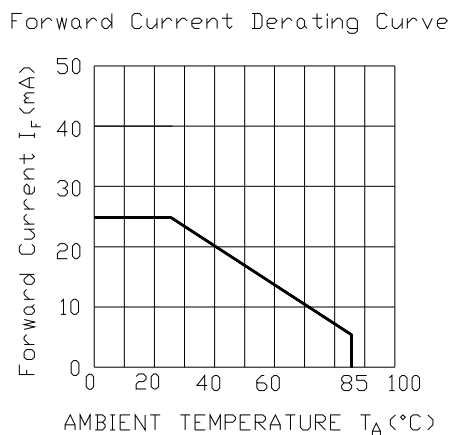
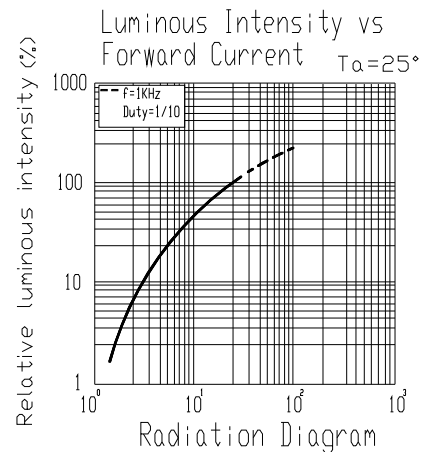
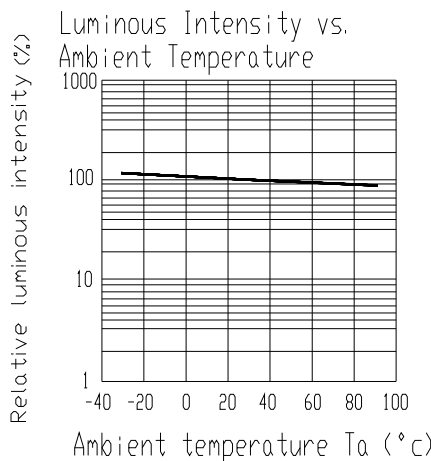
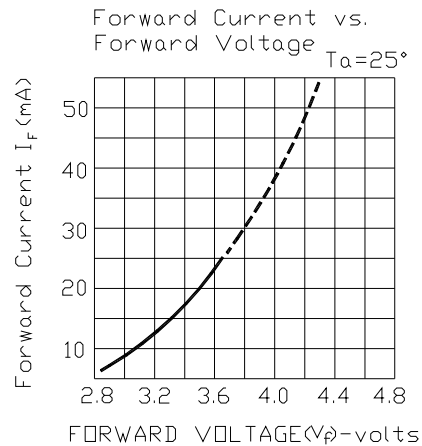
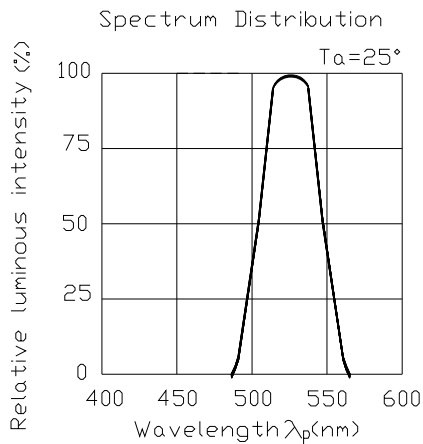

**Technical Data Sheet**  
**Full Color Top LEDs**

**67-23/R6GHBHC-B05/2T**

**Typical Electro-Optical Characteristics Curves (BH)**

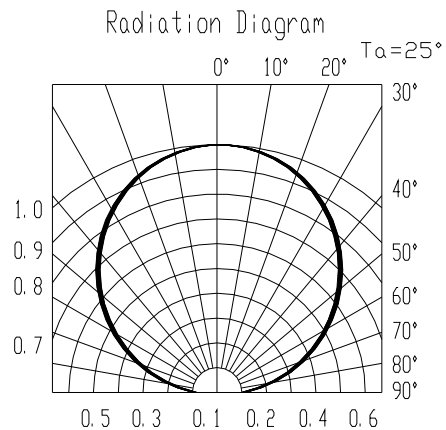
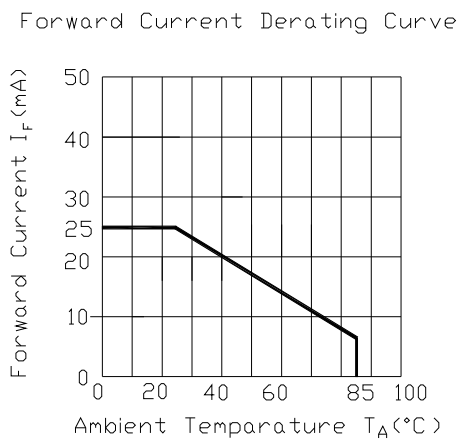
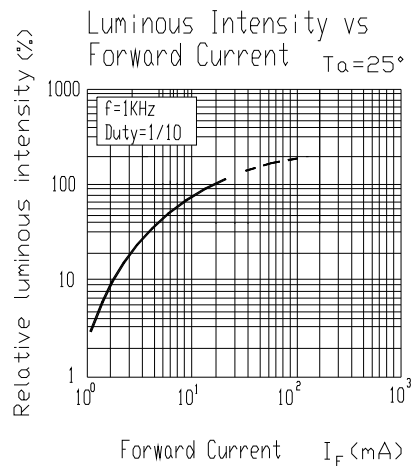
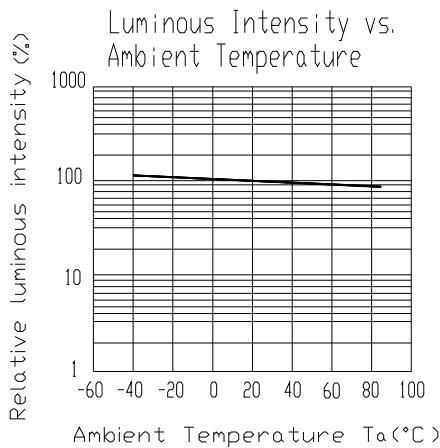
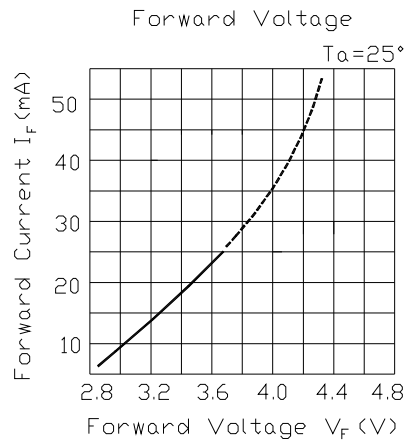
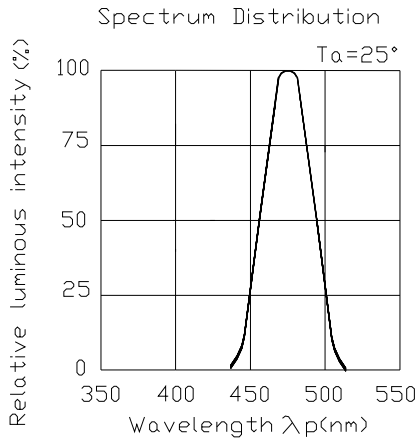



**Technical Data Sheet**  
**Full Color Top LEDs**

**67-23/R6GHBHC-B05/2T**

**Label Explanation**

CAT: Luminous Intensity Rank

HUE: Dom. Wavelength Rank

REF: Forward Voltage Rank

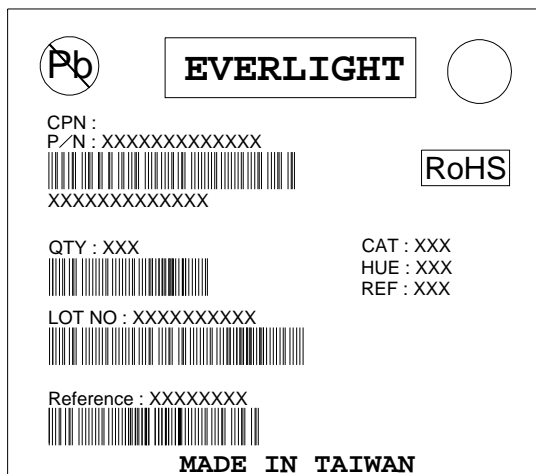

**Reel Dimensions**

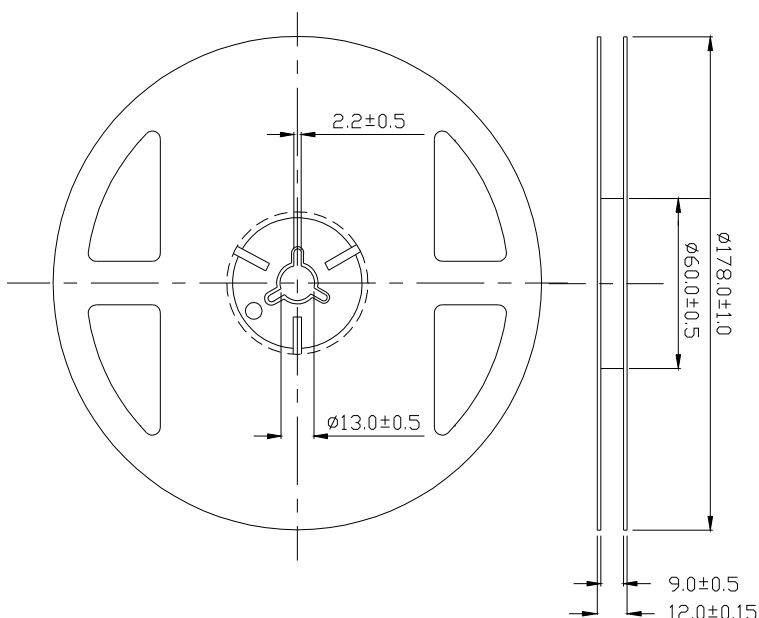

**Note:** Tolerances Unless Dimension  $\pm 0.1\text{mm}$  ,Unit = mm

**Technical Data Sheet**  
**Full Color Top LEDs**

**67-23/R6GHBHC-B05/2T**

**Carrier Tape Dimensions: Loaded Quantity 2000 pcs Per Reel**

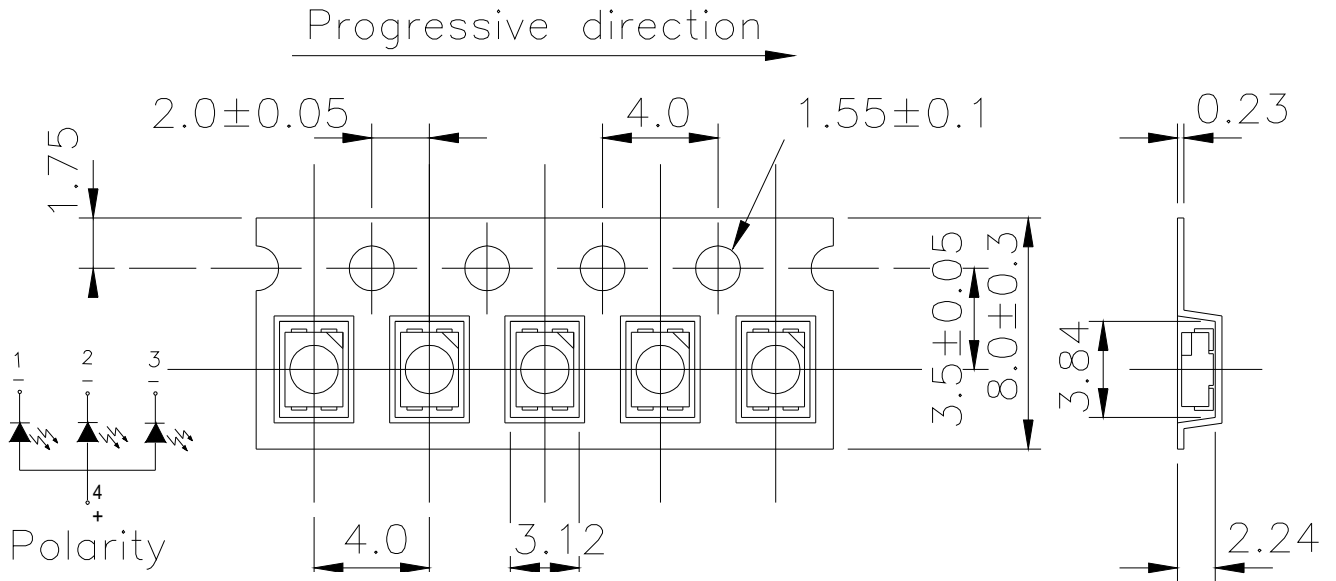

NOTE :TOLERANCES UNLESS DIMENSION  $\pm 0.1$  mm

UNIT: mm

**Moisture Resistant Packaging**

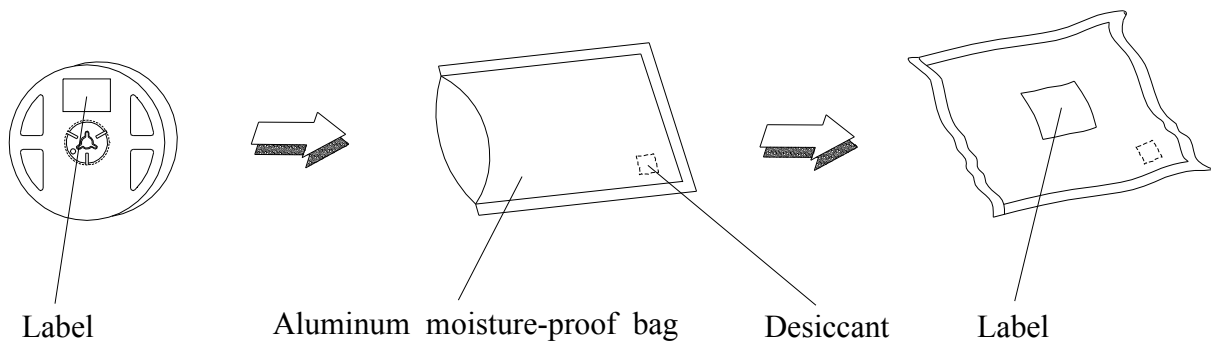

**Technical Data Sheet**

**Full Color Top LEDs**

**67-23/R6GHBHC-B05/2T**

**Reliability Test Items and Conditions**

The reliability of products shall be satisfied with items listed below.

Confidence level : 90%

LTPD : 10%

No.	Items	Test Condition	Test Hours/Cycles	Sample Size	Ac/Re
1	Reflow Soldering	Temp. : 260 ±5 Max 10 sec.	6 min	22 PCS.	0/1
2	Temperature Cycle	H : +100 15min ↓ 5 min L : -40 15min	300 Cycles	22 PCS.	0/1
3	Thermal Shock	H : +100 5min ↓ 10 sec L : -10 5min	300 Cycles	22 PCS.	0/1
4	High Temperature Storage	Temp. : 100	1000 Hrs.	22 PCS.	0/1
5	Low Temperature Storage	Temp. : -40	1000 Hrs.	22 PCS.	0/1
6	DC Operating Life	I <sub>F</sub> = 20 mA	1000 Hrs.	22 PCS.	0/1
7	High Temperature / High Humidity	85 /85%RH	1000 Hrs.	22 PCS.	0/1

## Technical Data Sheet

### Full Color Top LEDs

**67-23/R6GHBHC-B05/2T**

#### Precautions For Use

##### 1. Over-current-proof

Customer must apply resistors for protection, otherwise slight voltage shift will cause big current change ( Burn out will happen ).

##### 2. Storage

2.1 Do not open moisture proof bag before the products are ready to use.

2.2 Before opening the package: The LEDs should be kept at 30 °C or less and 90%RH or less.

2.3 After opening the package: The LED's floor life are 72 hours under 30 °C or less and 60% RH or less.

If unused LEDs remain, it should be stored in moisture proof packages.

2.4 If the moisture absorbent material (silica gel) has faded away or the LEDs have exceeded the storage time, baking treatment should be performed using the following conditions.

Baking treatment : 60±5 °C for 24 hours..

##### 3. Soldering Condition

##### 3.1 Pb free solder temperature profile

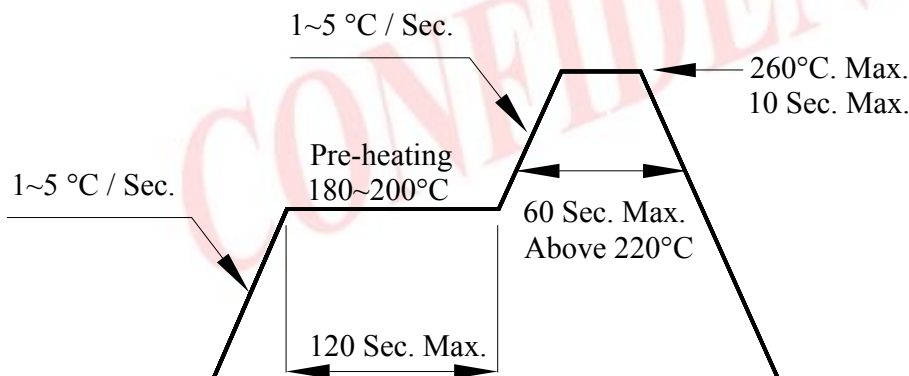

3.2 Reflow soldering should not be done more than two times.

3.3 When soldering, do not put stress on the LEDs during heating.

3.4 After soldering, do not warp the circuit board.

## Technical Data Sheet

### Full Color Top LEDs

#### 67-23/R6GHBHC-B05/2T

#### 4. Soldering Iron

Each terminal is to go to the tip of soldering iron temperature less than 350 for 3 seconds within once in less than the soldering iron capacity 25W. Leave two seconds and more intervals, and do soldering of each terminal. Be careful because the damage of the product is often started at the time of the hand solder.

#### 5. Repairing

Repair should not be done after the LEDs have been soldered. When repairing is unavoidable, a double-head soldering iron should be used (as below figure). It should be confirmed beforehand whether the characteristics of the LEDs will or will not be damaged by repairing.

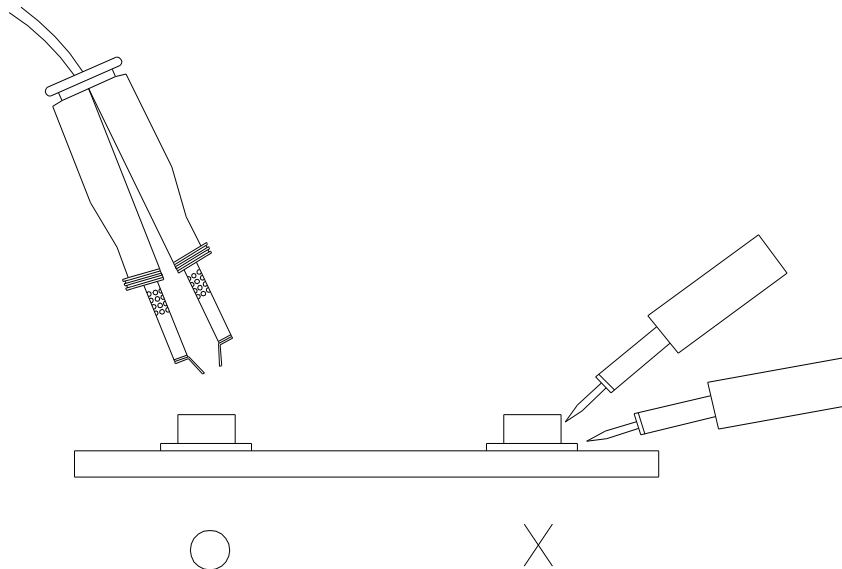

**EVERLIGHT ELECTRONICS CO., LTD.**

Office: No 25, Lane 76, Sec 3, Chung Yang Rd,  
Tucheng, Taipei 236, Taiwan, R.O.C

Tel: 886-2-2267-2000, 2267-9936

Fax: 886-2267-6244, 2267-6189, 2267-6306

<http://www.everlight.com>