

DUAL OPERATIONAL AMPLIFIER

FEATURES

- In the Linear Mode the Input Common Mode Voltage Range Includes Ground.
- Two Internally Compensated OP Amps are in Single Package.
- Low Power Dissipation and Power Drain Suitable for Battery Operation.
- Differential Input Voltage Range Equal to the Power Supply Voltage.
- Wide Power Supply Voltage Range and Signal Power Supply : Single Supply $3V_{DC}$ to $32V_{DC}$ Dual Supplies $\pm 1.5V_{DC}$ to $\pm 16V_{DC}$
- Large Output Voltage Swing : $0V_{DC}$ to $V_{CC}-1.5V_{DC}$ (Typ.)
- Low Input Biasing Current : $I_I=45nA_{DC}$ (Typ.)

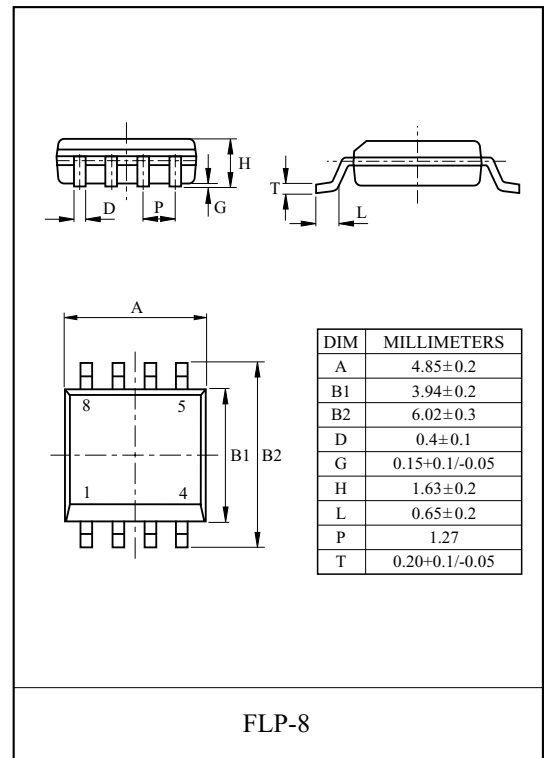

PIN CONNECTION (TOP VIEW)

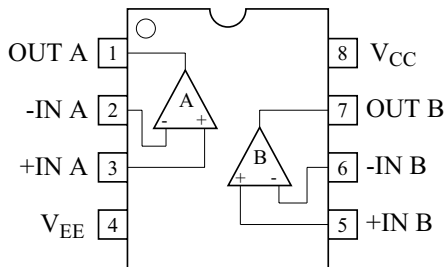

MARKING

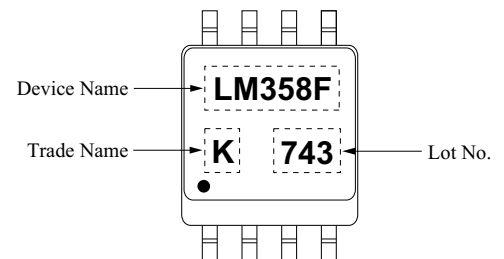

MAXIMUM RATINGS (Ta=25 °C)

CHARACTERISTIC	SYMBOL	RATING	UNIT
Supply Voltage	V_{CC}	32, +16	V
	V_{EE}	0, -16	
Differential Input Voltage	$V_{I(DIFF)}$	±32	V
Input Voltage	V_I	-0.3~32	V
Power Dissipation	P_D	280	mW
Operating Temperature	T_{OPR}	-40~85	°C
Storage Temperature	T_{STG}	-65~150	°C
Junction Temperature	T_J	125	°C

LM358F

EQUIVALENT CIRCUIT

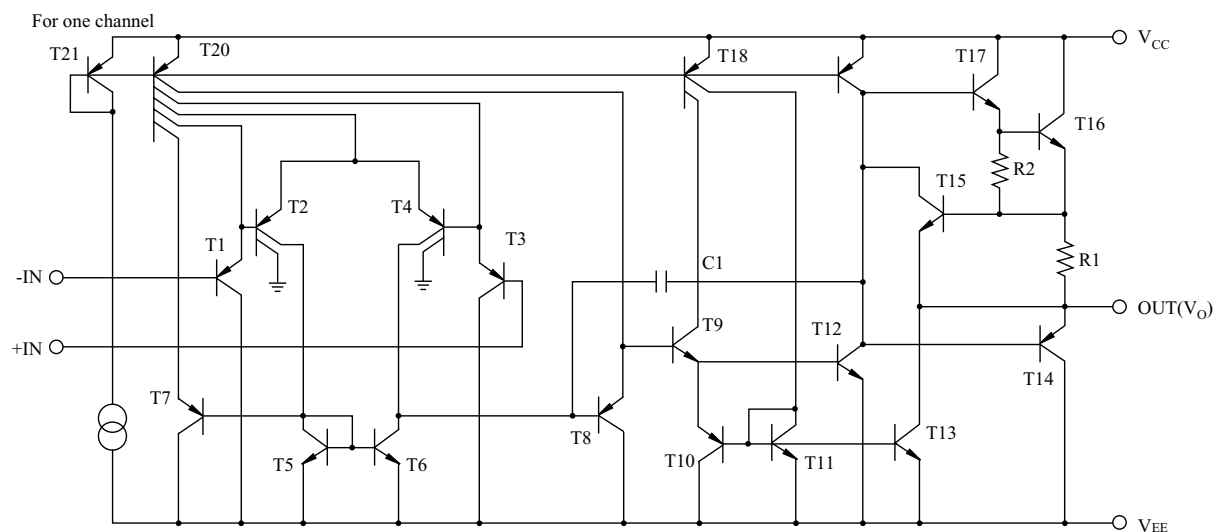

ELECTRICAL CHARACTERISTICS ($V_{CC}=5V$, $V_{EE}=GND$, $T_a=25^\circ C$, unless otherwise specified)

CHARACTERISTIC	SYMBOL	TEST CONDITION	MIN.	TYP.	MAX.	UNIT
Input Offset Voltage	V_{IO}	$V_{CM}=0V$ to $V_{CC}-1.5V$ $V_{O(P)}=1.4V$, $R_S=0\ \Omega$	-	2.9	7.0	mV
Input Offset Current	I_{IO}	-	-	5	50	nA
Input Bias Current	I_{BIAS}	-	-	45	250	nA
Input Common Mode Voltage	$V_{I(CM)}$	$V_{CC}=30V$	0	-	$V_{CC}-1.5$	V
Power Supply Current	I_{CC}	$R_L=\infty$, $V_{CC}=30V$	-	0.8	2.0	mA
		$R_L=\infty$, Full Temperature Range	-	0.5	1.2	mA
Large Signal Voltage Gain	G_V	$V_{CC}=15V$, $R_L \geq 2k\ \Omega$ $V_{O(P)}=1V \sim 11V$	25	100	-	V/mV
Output Voltage Swing	$V_{O(H)}$	$V_{CC}=30V$, $R_L=2k\ \Omega$	26	-	-	V
		$V_{CC}=30V$, $R_L=10k\ \Omega$	27	28	-	V
Common Mode Rejection Ratio	CMRR	-	65	80	-	dB
Power Supply Rejection Ratio	PSRR	-	65	100	-	dB
Channel Separation	CS	$f=1KHz \sim 20kHz$	-	120	-	dB
Short Circuit Current to Ground	I_{SC}	-	-	40	60	mA
Output Current	I_{SOURCE}	$V_{I(+)}=1V$, $V_{I(-)}=0V$ $V_{CC}=15V$, $V_{O(P)}=2V$	10	30	-	mA
		$V_{I(+)}=0V$, $V_{I(-)}=1V$ $V_{CC}=15V$, $V_{O(P)}=2V$	10	15	-	mA
	I_{SINK}	$V_{I(+)}=0V$, $V_{I(-)}=1V$ $V_{CC}=15V$, $V_{O(P)}=200mV$	12	100	-	mA
Differential Input Voltage	$V_{I(DIFF)}$	-	-	-	V_{CC}	V

LM358F

Fig. 1 Input Current vs Temperature

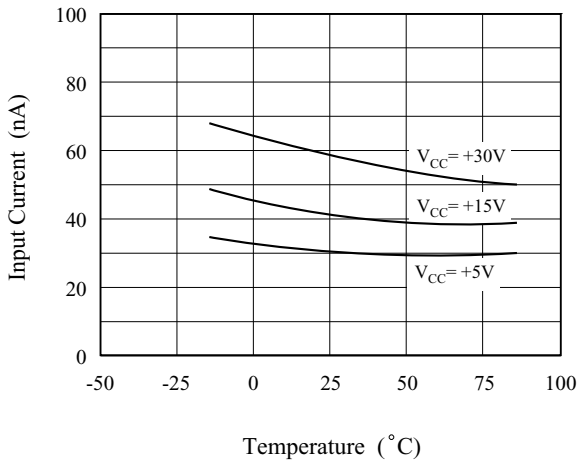

Fig. 2 Supply Current vs Supply Voltage

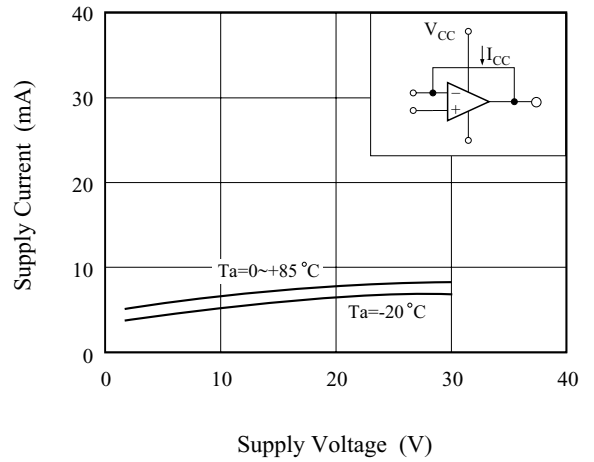

Fig. 3 Voltage Gain vs Supply Voltage

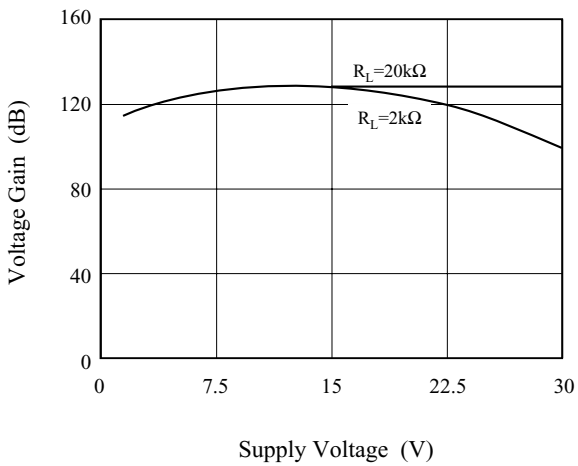

Fig. 4 Open Loop Frequency Response

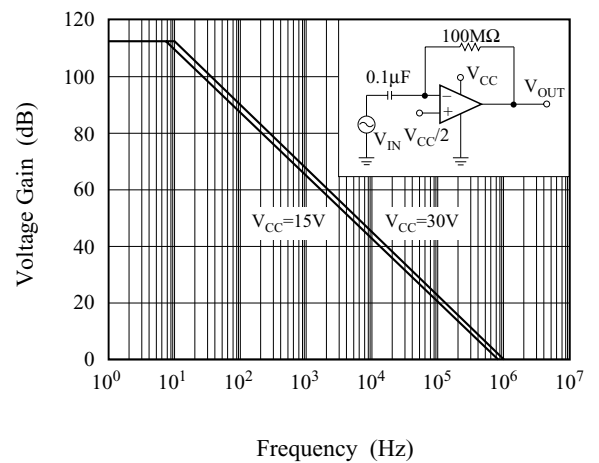

Fig. 5 Large signal Frequency Response

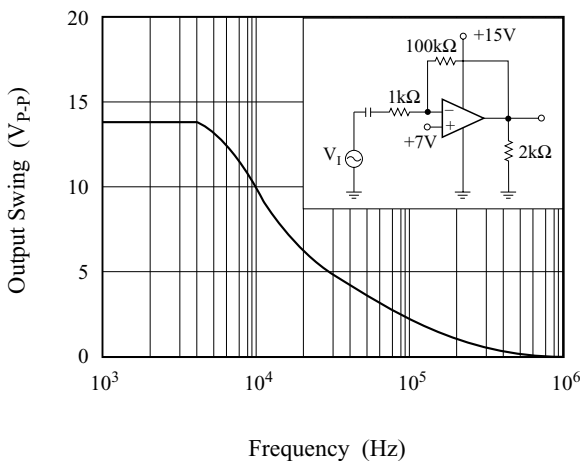
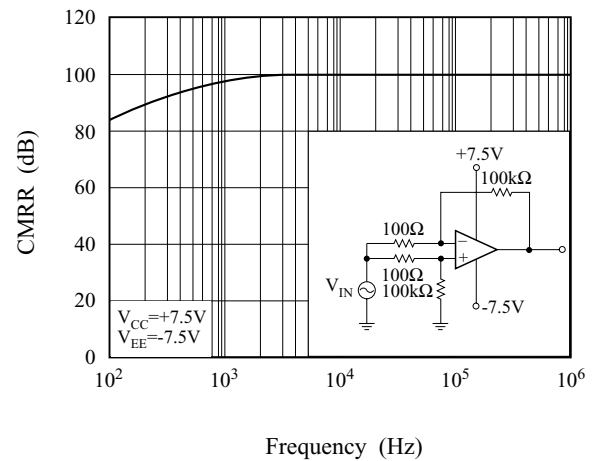

Fig. 6 CMRR vs Frequency



LM358F

Fig. 7 Voltage Follower Pulse Response

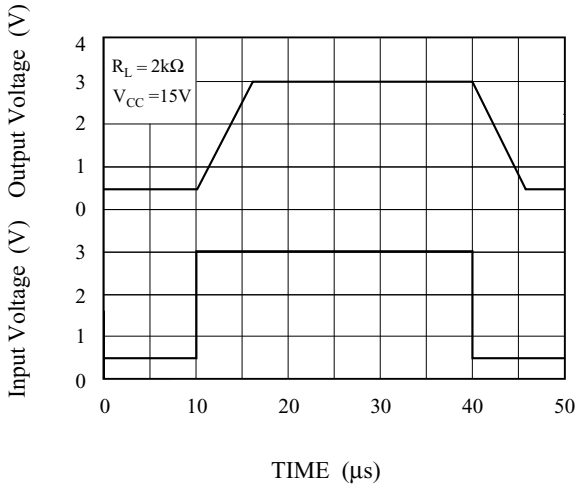

Fig. 8 Voltage Follower Response (Small Signal)

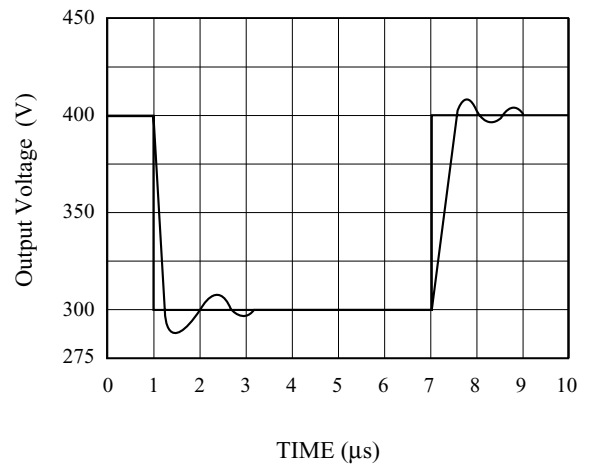

Fig. 9 Output Characteristics Current Sourcing

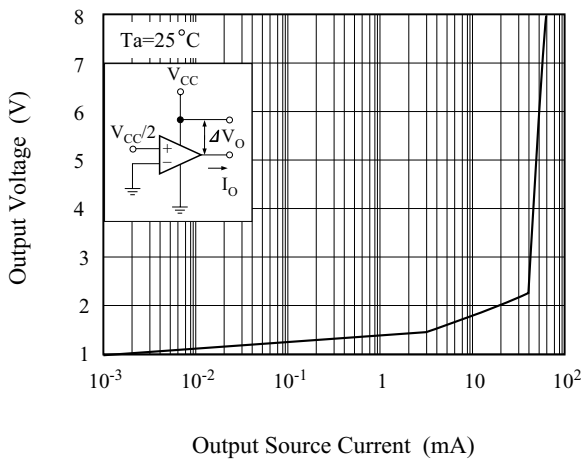

Fig. 10 Output Characteristics Current Sinking

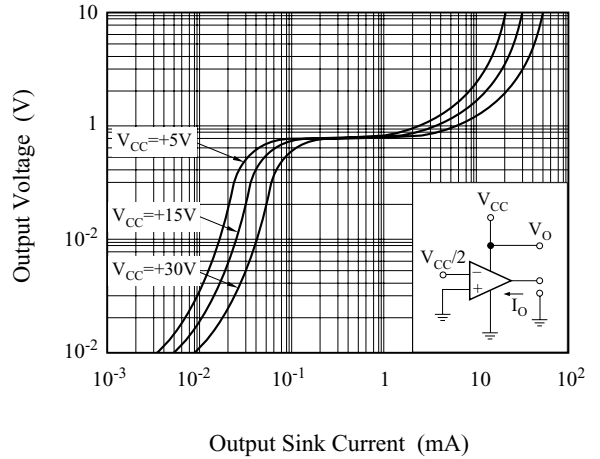

Fig. 11 Current Limiting

