



PJ4800

30V N-Channel Enhancement Mode MOSFET

FEATURES

- $R_{DS(ON)}$, $V_{GS}@10V, I_{DS}@8A=20m\Omega$
- $R_{DS(ON)}$, $V_{GS}@5.0V, I_{DS}@6A=31m\Omega$
- Advanced Trench Process Technology
- High Density Cell Design For Ultra Low On-Resistance
- Specially Designed for DC/DC Converters
- Fully Characterized Avalanche Voltage and Current
- Pb free product : 99% Sn above can meet RoHS environment substance directive request

MECHANICAL DATA

- Case: SOIC-08 Package
- Terminals : Solderable per MIL-STD-750D, Method 1036.3
- Marking : 4800

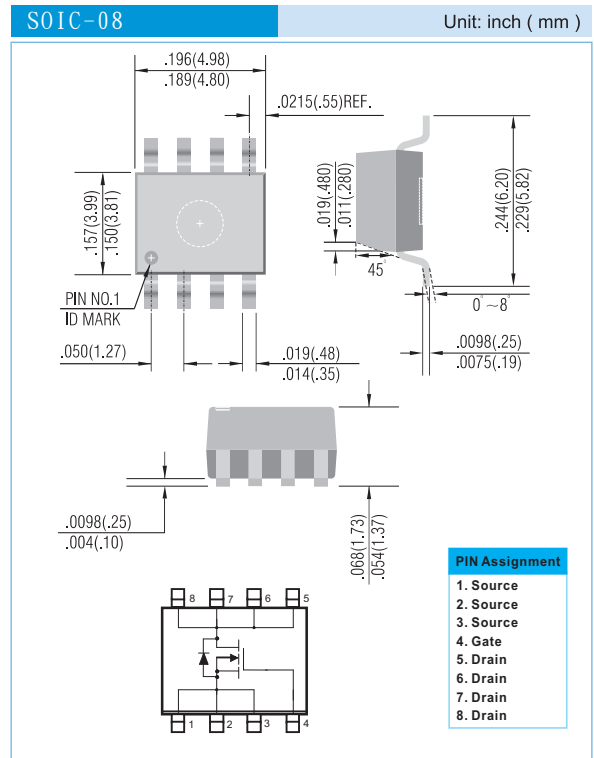

Maximum RATINGS and Thermal Characteristics ($T_A=25^\circ\text{C}$ unless otherwise noted)

PARAMETER		SYMBOL	VALUE	UNIT
Drain-Source Voltage		V_{DS}	30	V
Gate-Source Voltage		V_{GS}	± 20	V
Continuous Drain Current	$T_C=25^\circ\text{C}$	I_D	8	A
Pulsed Drain Current ⁽¹⁾		I_{DM}	32	A
Avalanche Energy $L=0.1\text{mH}, I_D=8\text{A}, V_{DD}=25\text{V}$		E_{AS}	3.2	mJ
Power Dissipation	$T_C=25^\circ\text{C}$	P_D	3	W
	$T_C=75^\circ\text{C}$		2	
Operating Junction and Storage Temperature Range		T_J, T_{STG}	-55 to +175	$^\circ\text{C}$
Junction-to-Ambient Thermal Resistance(PCB Mounted) ²		$R_{\theta JA}$	50	$^\circ\text{C/W}$

Note: 1. Maximum DC current limited by the package
2. Surface mounted on FR4 board, $t \leq 10$ sec

PAN JIT RESERVES THE RIGHT TO IMPROVE PRODUCT DESIGN,FUNCTIONS AND RELIABILITY WITHOUT NOTICE



PJ4800

ELECTRICAL CHARACTERISTICS (Tc=25oC, Unless Otherwise Noted)

PARAMETER	SYMBOL	TEST CONDITIONS	MIN.	TYP.	MAX.	UNIT
STATIC						
Drain-Source Breakdown Voltage	$V_{(BR)DSS}$	$V_{GS}=0V, I_D=250\mu A$	30	-	-	V
Gate Threshold Voltage	$V_{GS(TH)}$	$V_{DS}=V_{GS}, I_D=250\mu A$	1	-	3	V
Drain-Source On-state Resistance	$R_{DS(ON)}$	$V_{GS}=10V, I_D=8A$	-	16	20	mΩ
		$V_{GS}=5V, I_D=6A$	-	23	31	mΩ
Gate-Body Leakage	I_{GSS}	$V_{DS}=0V, V_{GS}=\pm 20V$	-	-	± 100	nA
Zero Gate Voltage Drain Current	I_{DSS}	$V_{DS}=24V, V_{GS}=0V$	-	-	1	μA
		$V_{DS}=24V, V_{GS}=0V, T_J=125^\circ C$	-	-	25	μA
On-State Drain Current	$I_{D(ON)}$	$V_{DS}=10V, V_{GS}=10V$	8	-	-	A
Forward Transconductance	gfs	$V_{DS}=5V, I_D=8A$	10	-	-	S
DYNAMIC						
Total Gate Charge	Q_G	$V_{DS}=15V, V_{GS}=5V, I_D=8A$	-	7.0	-	nC
		$V_{DS}=15V, V_{GS}=10V, I_D=8A$	-	14.2	-	nC
Gate-Source Charge	Q_{GS}	$V_{DS}=15V, V_{GS}=10V, I_D=8A$	-	1.22	-	nC
Gate-Drain Charge	Q_{GD}		-	3.44	-	nC
Turn-On Delay Time	$t_{d(on)}$	$V_{DS}=15V, I_D=1A, V_{GS}=10V, R_{GS}=6\Omega$	-	7.8	-	nS
Rise Time	t_r		-	11.6	-	nS
Turn-Off Delay Time	$t_{d(off)}$		-	28.8	-	nS
Fall Time	t_f		-	5.6	-	nS
Input Capacitance	C_{ISS}	$V_{GS}=0V, V_{DS}=15V, f=1MHz$	-	520	-	pF
Output Capacitance	C_{OSS}		-	112	-	pF
Reverse Transfer Capacitance	C_{RSS}		-	98	-	pF
SOURCE-DRAIN DIODE RATINGS AND CHARACTERISTICS						
Continuous Current	I_S		-	-	2.3	A
Forward Voltage	V_{SD}	$I_F=2.3A, V_{GS}=0V$	-	-	1.2	V

NOTE : Plus Test: Pluse Width $\leq 300\mu s$, Duty Cycle $\leq 2\%$.

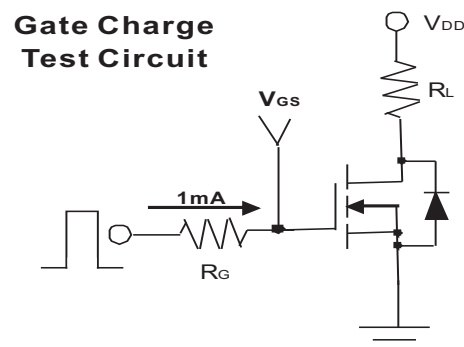
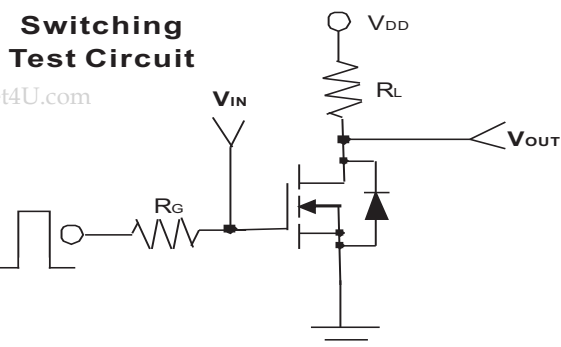



PJ4800

Typical Characteristics Curves ($T_a=25^\circ\text{C}$, unless otherwise noted)

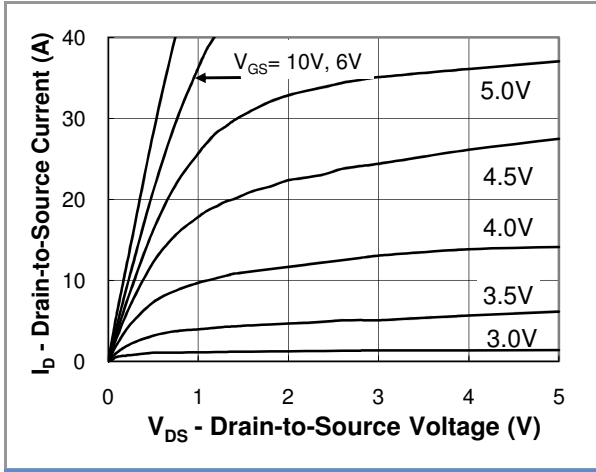

Fig.1 Output Characteristic

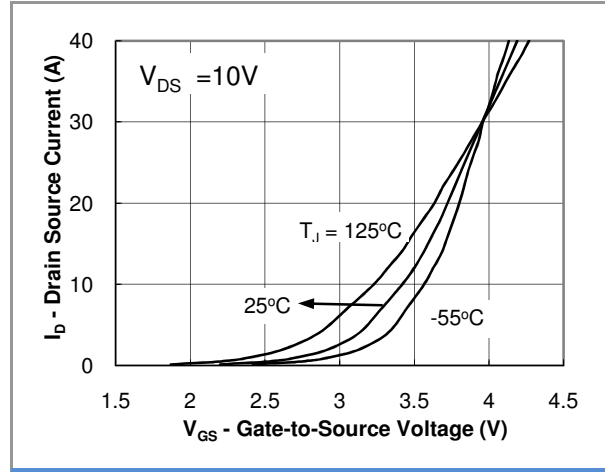

Fig.2 Transfer Characteristic

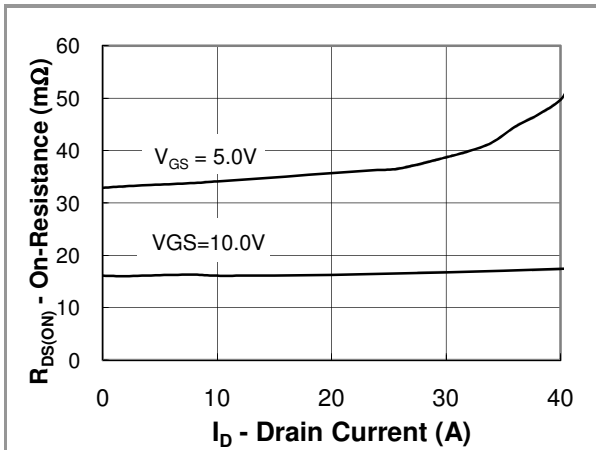

Fig.3 On Resistance vs Drain Current

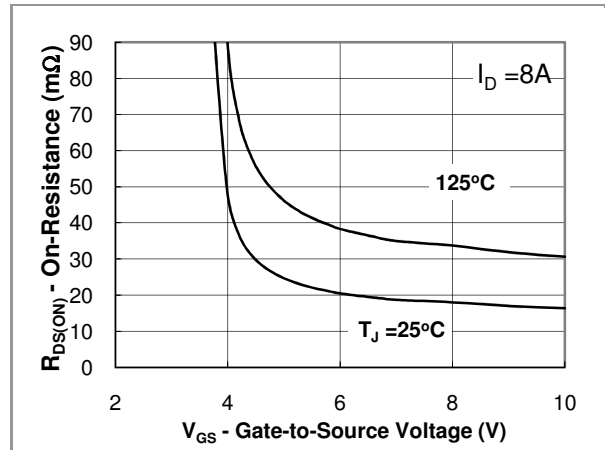

Fig.4 On Resistance vs Gate to Source Voltage

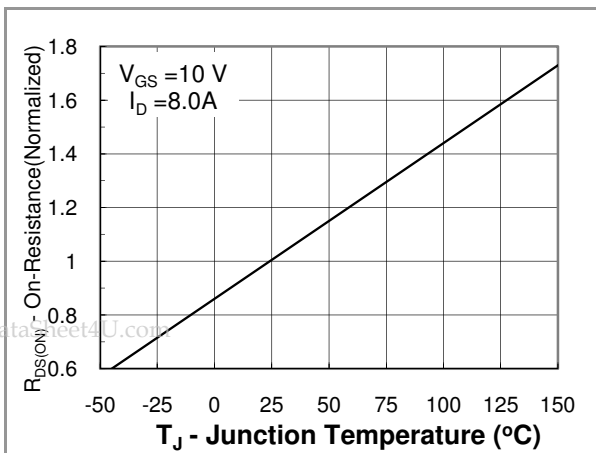

Fig.5 On Resistance vs Junction Temperature

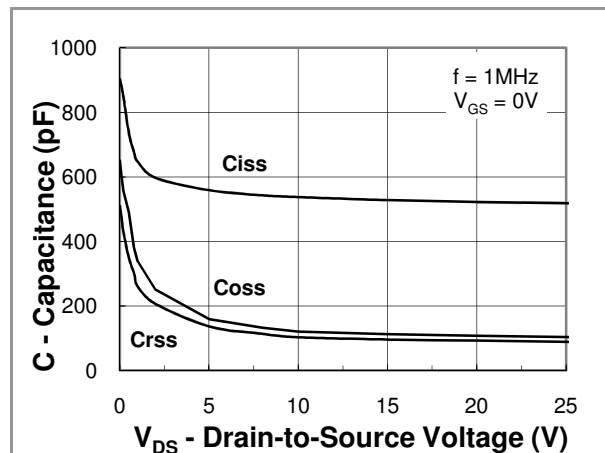

Fig.6 Capacitance



PJ4800

Typical Characteristics Curves ($T_a=25^\circ\text{C}$, unless otherwise noted)

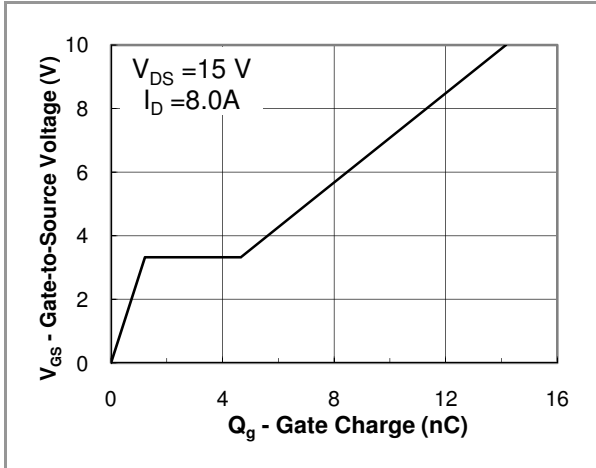

Fig. 7 Gate Charge Waveform

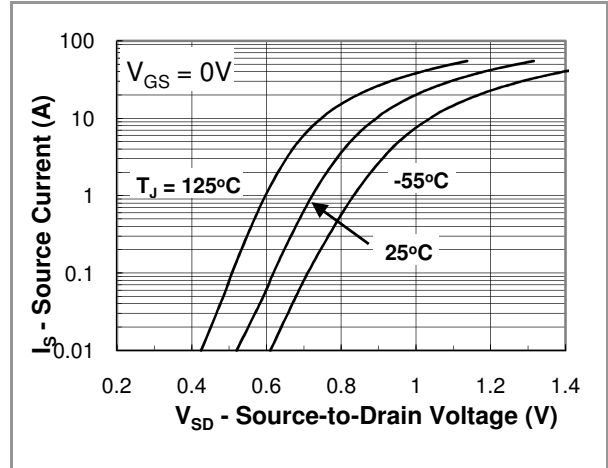

Fig. 8 Source-Drain Diode Forward Voltage

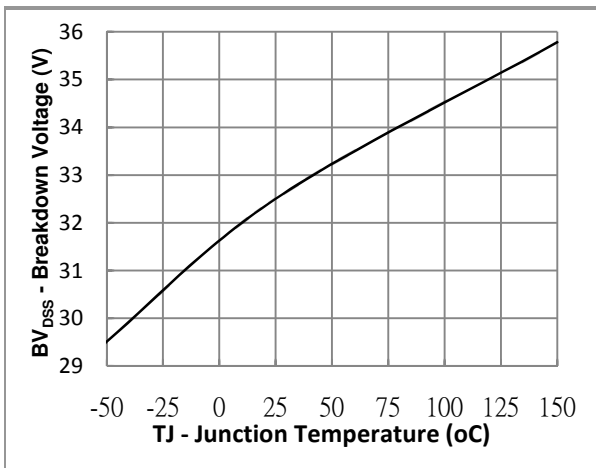

Fig.9 Breakdown Voltage vs Junction Temperature

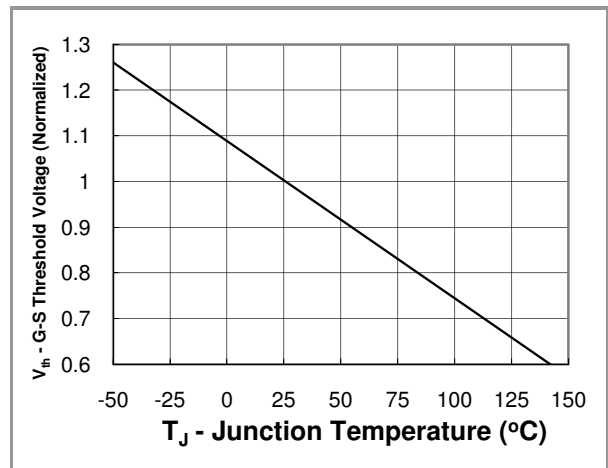
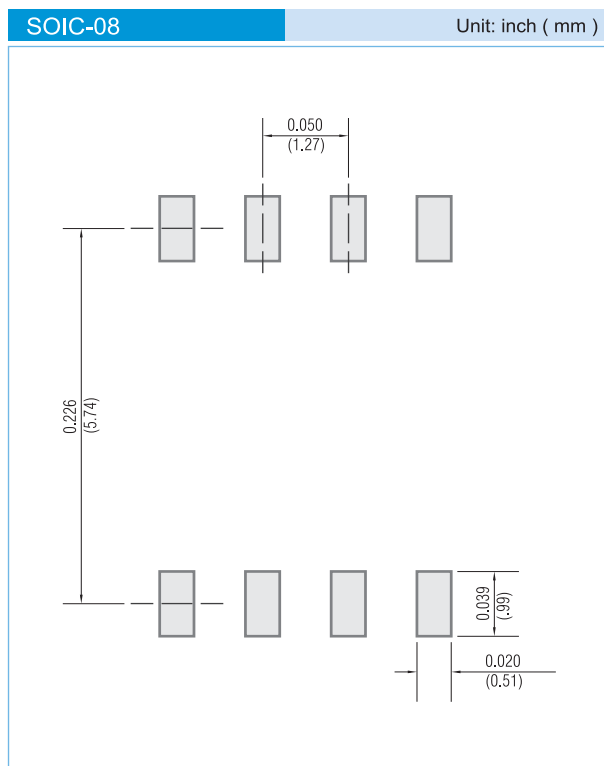

Fig.10 Threshold Voltage vs Junction Temperature



PJ4800

MOUNTING PAD LAYOUT



ORDER INFORMATION

- Packing information
T/R - 3K per 13" plastic Reel

LEGAL STATEMENT

Copyright PanJit International, Inc 2010

The information presented in this document is believed to be accurate and reliable. The specifications and information herein are subject to change without notice. Pan Jit makes no warranty, representation or guarantee regarding the suitability of its products for any particular purpose. Pan Jit products are not authorized for use in life support devices or systems. Pan Jit does not convey any license under its patent rights or rights of others.