

Adaptive Logic™

General Description

The AL220 is an inexpensive, high performance, stand alone micro controller utilizing Fuzzy Logic control. Because the AL220 is a dedicated controller, it offers superior ease-of-use, performance, features, and robustness in harsh operating environments.

The device contains four 8-bit resolution analog inputs and four 8-bit analog outputs, and an internal clock generator. Inputs can be directly connected to sensors or switches. Outputs can be connected to analog devices or used to control a mechanism. The AL220 consumes very little power during normal operation and has a power-down mode that reduces power by a factor of 1000.

Fuzzy logic is a powerful processing methodology that easily accommodates imprecise input data and system nonlinearities for rapid development of robust control systems.

The AL220 can be used to inexpensively add intelligence to a wide variety of products, improve performance and

features, increase efficiency and solve nonlinear control problems.

The device's memory (EEPROM/ROM) stores functions and rule parameters. The AL220 is flexible and efficiently adapts to the requirements of the application.

Unique FLOATING MEMBERSHIP™ Functions can measure derivatives, build timers, and adjust for sensor drift, all without extra external components or lookup tables.

Applications information is entered using the INSIGHT II™ development system running under Windows. The field-programmable AL220 can be reprogrammed numerous times. Simply enter any design changes using the INSIGHT II system and produce a newly programmed device in seconds!

The AL220 is available in either an 18-pin DIP or 20-pin SOIC. The devices are ideal for a wide range of applications, including smart appliances, motor control, automotive, and industrial systems.

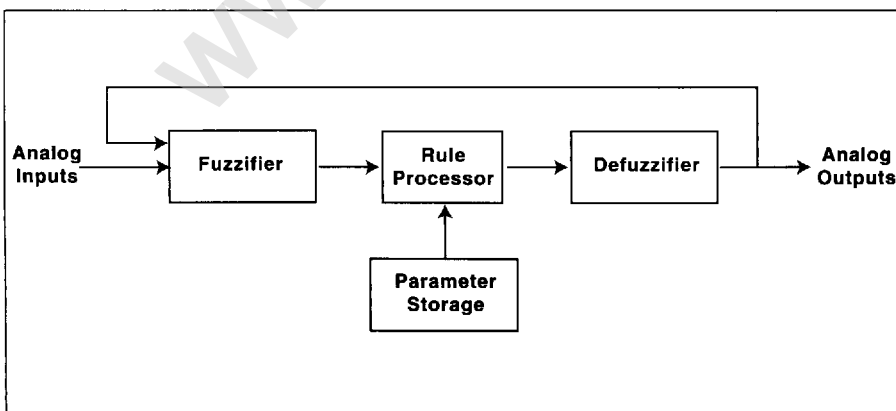

Figure 1. AL220 Block Diagram

AL220 Stand-Alone Fuzzy Logic Controller Preliminary Data

Features

- Complete, Single Chip Fuzzy Logic Micro Controller
- Four 8-Bit Analog Inputs
- Four 8-Bit Analog Outputs
- Programmable Analog IC (PAIC™)
- Flexible, Intelligent Control
- EEPROM and ROM
- FLOATING MEMBERSHIP™ Functions
- Low Operating Power-Very Low Standby Mode (< 10µA Typical)
- PC - Windows Based Development System
- Low-Cost Plastic Packages-18 pin DIP, 20 pin SOIC

Applications

- Motion and Position Control
- Temperature Control
- PID Type Control
- Motor Control
- Power Management
- Intelligent Sensors
- Configurable Analog
- Automotive
- Appliance Control

Adaptive Logic™

800 Charcot Avenue, Suite 112
San Jose, CA 95131
Phone: (408) 383-7200
Fax: (408) 383-7201
800-659-5055
E-mail:
75471.2025@compuserve.com

Device Architecture

Figure 1 shows a block diagram of the AL220. The main elements are the Fuzzifier, Defuzzifier, and controller. The Fuzzifier converts input data into Fuzzy data. The Fuzzifier, in conjunction with the controller, evaluates fuzzy data by a user-defined set of rules that describes how the system is to be controlled. When the rules have been evaluated, the Defuzzifier sets the output to the appropriate value. Figure 2 shows pin assignments.

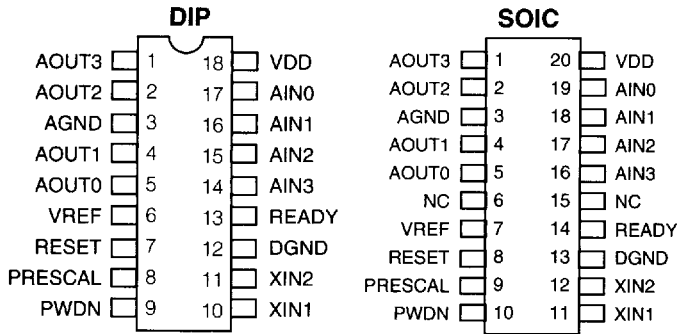

Figure 2. Package Pin Assignments.

Table 1. Absolute Maximum Ratings.

Parameter	Min	Max	Units
Voltage on Any Pin ¹	-0.5	7.0	V
Power Dissipation		300	mW
Storage Temperature	-65	150	°C
Operating Temperature	-55	125	°C

¹ Respect to Ground

* **Notice:** Stresses beyond those listed under "Absolute Maximum Ratings" may cause permanent damage to the device. This is a stress rating only and functional operation of the device at these or any other conditions beyond those indicated in the operational sections of this specification is not implied. Exposure to absolute maximum rating conditions for extended periods may affect device reliability.

Note: 1. Minimum voltage is -0.5 V dc and maximum voltage is $V_{dd}+0.5$ V dc. Undershoot to -2.0 V dc and overshoot to +7.0 V dc allowed for pulse widths less than 20ns.

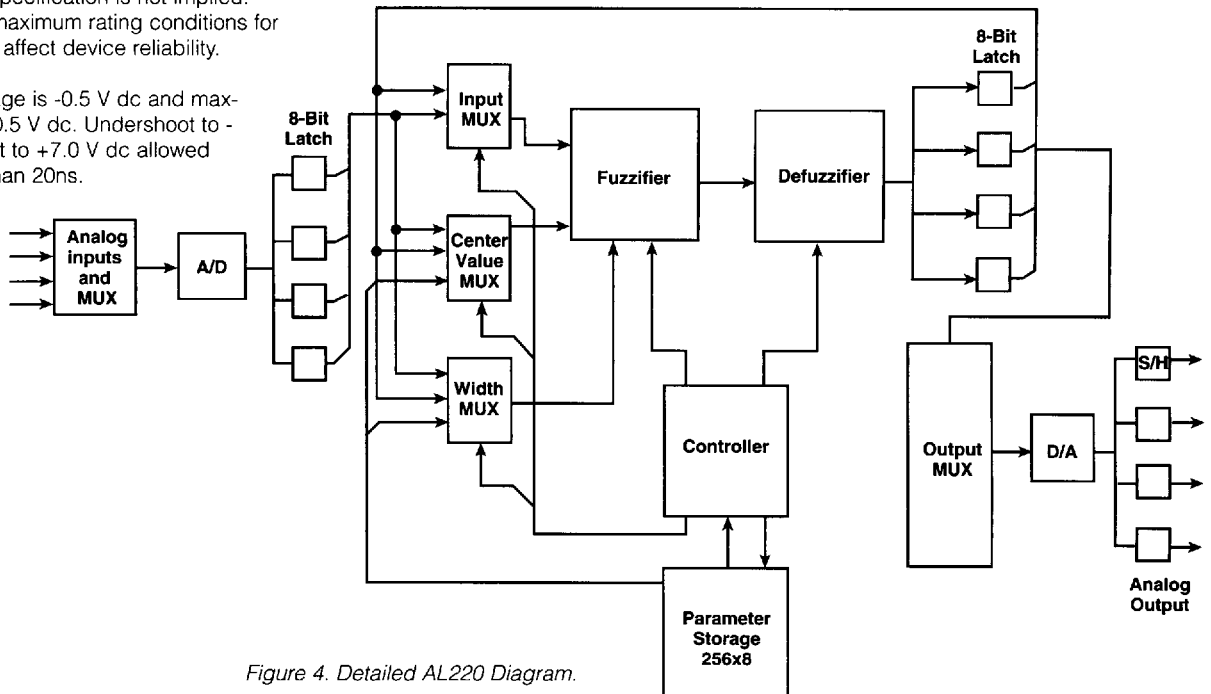

Figure 4. Detailed AL220 Diagram.

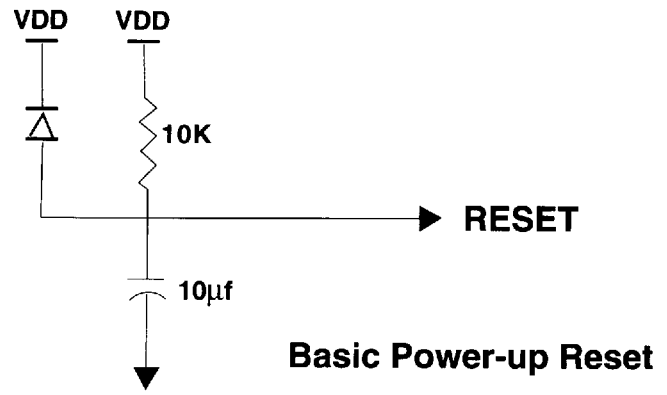

Figure 3. Power up Reset.

Pin Descriptions

Inputs

RESET

An active-low signal that initializes the device. RESET should remain active for at least eight clock cycles to ensure proper operation. RESET can be driven by a power-up delayed circuit.

AIN (0:3)

Analog input data. Analog data is internally converted to 8-bit digital data. Unused inputs should be connected to ground.

- PRESCALE** A logic level that puts the device into prescale mode while a zero causes normal operation. The pin can be grounded if prescale mode is never used, or it can be connected to the READY pin for continuous use. The mode can also be invoked during operation by external logic. After RESET is deasserted, the PRESCALE pin must be held to a logic low for at least four clock cycles. (Prescale operation is described in Timing section.)
- XIN1** Clock input. May be driven by an external clock or connected to one side of a crystal or the center tap of an RC network. The other side of the capacitor connector to DGND.
- XIN2** Second clock input. Connects to the other side of the crystal (or the R in the RC network) on XIN1.
- PWDN** Power down mode control. For normal operation, this pin should be tied to VDD. To initiate a power-down sequence, drive this pin to ground. (Power-down mode is described later in Timing section.)
- NC** No connect pins. Even though these pins are not used in the device, it is best to connect them to ground.

Table 2. Specifications and Recommended Operating Conditions

Parameter	Min	Max	Units
V _{DD} Supply Voltage	4.75	5.25	V
I _{DD} Supply Current, Active/at 10MHz		30	mA
I _{DD} Supply Current, Power Down		20	μA
V _{OL} Ready Output Voltage, I _{OL} = 5mA		0.4	V
V _{OH} Ready Output Voltage, I _{OH} = -40μA	3.5		V
F Clock Frequency	1	10	MHz
V _{IL} Digital Input Low-Level Voltage	0	0.8	V
V _{IH} Digital Input High-Level Voltage	3.5	V _{DD}	V
V _{IHP} PWDN Input High-Level Voltage	4.0	V _{DD}	V
I _{IL} Digital Input Low-Level Current	-10		μA
I _{IH} Digital Input High-Level Current		10	μA
I _{IHP} PWDN Input Current	-20	20	μA
Z _{IN} Analog Input Impedance	100		kΩ
V _{IN} Analog Input Voltage Range	V _{DD} *0.1	V _{DD} *0.9	V
V _O Analog Output Voltage Range	V _{DD} *0.1	V _{DD} *0.9	V
I _O Analog Output Current	-5	5	mA
T _w Reset Pulse Width	800		ns
T _A Operating Ambient Temperature	0	70	°C

Power Pins

- VDD** Positive power supply pin for both digital and analog sections. Nominally 5.0V
- AGND** Analog ground pin. This PC board trace should remain separate from digital ground pin traces as long as possible.
- DGND** Digital section ground pin.

Outputs

- AOOUT (0:3)** Analog output data. Eight-bit digital data is internally converted to an analog level.
- READY** After a reset, this pin signals that the device is ready to sample and process data. The pin can be connected to PRESCALE to invoke prescale mode.
- VREF** Filters the internal reference voltage. Connect to AGND through a 0.1μF capacitor.

Table 3. A/D Converter Characteristics(1).

Parameter	Min	Max	Units
Resolution	8	8	Bits
Non-Linearity		±1	LSB
Zero Accuracy		±1	LSB
Full Scale Accuracy		±2	LSB
Total Unadjusted Error		±2	LSB
Quantizing Error		±1	LSB
Absolute Accuracy		±3	LSB
Conversion Range	V _{DD} *0.1	V _{DD} *0.9	V
Conversion Time		256	1/F
Input Capacitance		35	pF

- Note: 1. Monotonicity is guaranteed.
 2. Settling time specified for full scale step to ± 4 LSB

Table 4. D/A Converter Characteristics(1).

Parameter	Min	Max	Units
Resolution	8	8	Bits
Non-Linearity		±1	LSB
Zero Accuracy		±1½	LSB
Full Scale Accuracy		±2	LSB
Output Voltage Range	V _{DD} *0.1	V _{DD} *0.9	V
Conversion Time and Output Settling Time ⁽²⁾		256	1/F

- Notes: 1. Monotonicity is guaranteed.
 2. Settling time specified for full scale step to ± 4 LSB

Timing

Figure 5 illustrates timing for the AL220. The three architectural blocks that impact timing include the multiplexed input A/D converter, the Fuzzy Processor, and the multiplexed output D/A converter (see figure 4).

Processing speed is a function of both the clock rate and the number of clocks (1024) required to complete data sampling and processing cycles. The clock maximum rate is 10 MHz and the minimum is 1 MHz.

Operating Timing

Reset. When the RESET pin is active, it clears all of the internal registers. The READY output remains low until four clocks after RESET goes high. The analog outputs hold at the level they were prior to the assertion of reset. The stored digital values of the inputs and outputs are reset to zero. When RESET is deactivated, the device begins sampling inputs during the first 1024 clock cycle. Initially, outputs are set to $VDD \cdot 0.1V$.

Input Conversion Input analog values are converted to digital data and latched internally in successive periods of 256 clocks each. A total of 1024 clock cycles are required to convert all four inputs after which the conversion process repeats. At the maximum clock, the sampling rate for each input is 10 KHz, or 100 microseconds.

Processor Timing

The first 1024 clock processing cycle begins after the first input conversion cycle has completed. Processing cycles consist of 1024 clock cycles regardless of the number of variables and rules used.

Variable and rule evaluations require four clocks each. For example, a rule with two variables would require 12 clocks to process. During a processing cycle, either a variable or rule is being processed each four-clock period, except for a 64-clock latency period at the end of the processing cycle.

Internal Loopback Delay

When data in the output latches are internally looped back as inputs, they lag behind the analog inputs by the 1024 clocks of the initial sampling cycle. After that, as the output latches are updated during processing the data feedback is used as inputs.

Prescaled Operation

The AL220 contains a loadable prescale counter that allows it to be inactive for periods of time. The feature is used to vary the rates of sampling and processing. The PRESCALE pin selects normal or prescaled operation.

In prescale mode, the processor is inactive for periods of 1024 clocks after which the counter counts. When the count completes, the processor activates for a single 1024 clock period and performs fuzzy computations and reloads the counter.

The PRESCALE pin is held low when not in use, or tied to the READY pin for continuous prescale operation. External logic can also control the pin allowing the prescale function to be asserted during different periods of operation.

Power-down Mode

The AL220 enters a very low power mode when the user holds the PWDN pin low. When the present 1024 clock cycle completes, I_{DD} drops to $< 10\mu A$ (typically) and the READY pin drops to a low level.

Driving the PWDN pin to $> 4V$, reactivates the device. The AL220 then waits $1024 \cdot 255$ clock cycles before powering up. After this time-out period completes, the READY pin returns to a high level and processing begins.

During power down, the analog sections are idle. All output voltages slowly droop to zero volts. When PWDN rises, the AL220 goes through a start-up cycle as described previously.

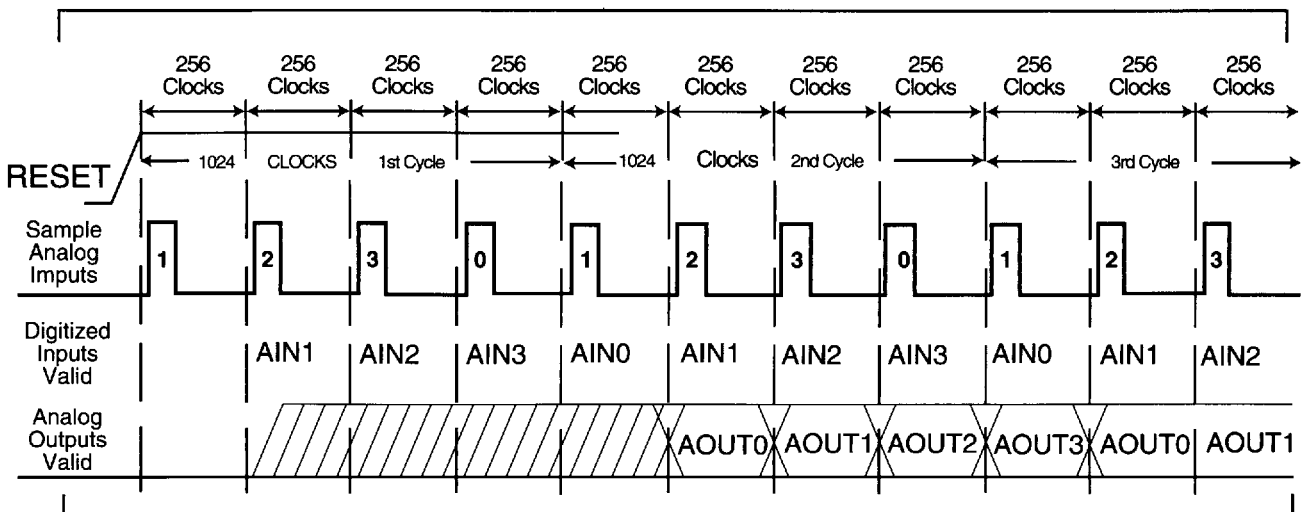

Figure 5. Timing Considerations.

Device Operation

Note: For an overview of developing a fuzzy Logic System see Appendix A

Processing data involves several steps. First, sampled analog data is converted to digital and latched. Next, the Fuzzifier compares the contents of the input latches with the membership functions to find digital values for the Fuzzy variables. The Fuzzifier also performs the MAX-of-MIN (see Appendix A) calculation to determine the winning rule. Last, the Defuzzifier determines the winning rule's action value and latches it for conversion to an analog output or internal feedback.

Fuzzifier

The Fuzzifier compares latched input data with membership functions to calculate the value of a variable. When the MIN calculation has been performed on all the variables in a rule, the value representing the rule is stored. When the MAX calculation has been performed on all the rules referencing an output, the winning rule's action value is passed to the Defuzzifier.

Rules are evaluated in the order they are entered. Any rule can reference any output. Outputs can be referenced repeatedly in a rule set.

When a rule or group of rules affecting an output has been entered and the next rule entered references another output, the compiler automatically inserts the code for the Last Rule causing the output to be updated with the action value of the winning rule.

An output may be updated as many times during a processing cycle as there are separate groups of rules referencing it.

Note: input sampling is continuous. Analog output values are also updated continuously. During the course of a processing cycle, a variable may use a data sample from the previous sample cycle or from the current cycle depending on where the input sampling cycle is relative to the processing cycle. Should more than one group of rules reference the same input and output, then the output value may change more than once during a processing cycle based on different input data.

Defuzzifier

The winning rule's action value and mode data are passed to the Defuzzifier block. Digital data is latched and converted to analog to drive the outputs and looped back internally to be available on rule inputs.

If all the rules in a group referencing an output evaluate to zero, then the output will not change its value. If more than one rule evaluates to the same highest non zero value, then the first of those rules entered will win and its action will determine the output.

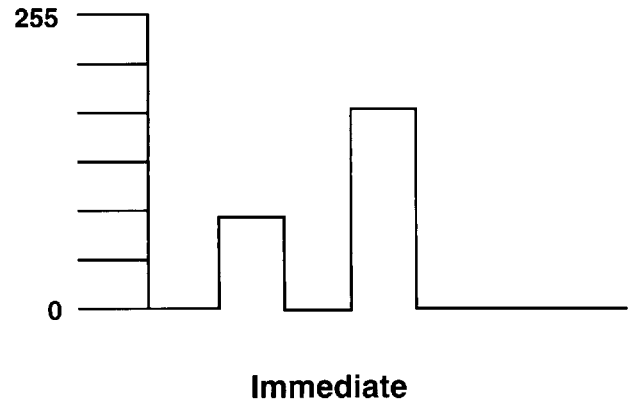

Figure 6. Immediate Defuzzification.

Defuzzification Methods

Defuzzification causes the action value of the winning rule to drive an output. The device supports two methods of defuzzification, immediate and accumulate. Either of the two modes depicted in Figure 6 and 7 can be selected for a rule.

Immediate Mode – The immediate mode functions like a lookup table, where the action value assigned to the winning rule during entry is applied to an output.

Immediate defuzzification is useful when the output value must be absolute or when large changes are required.

Accumulate Mode – The Accumulate mode increments or decrements the existing output by the action value for the winning rule. The output is a function of the current action and the previous output.

Accumulate defuzzification can be used for relative changes to outputs when the system under control is near a desired operating point. It is also useful for timing functions. The output register will not overflow or underflow.

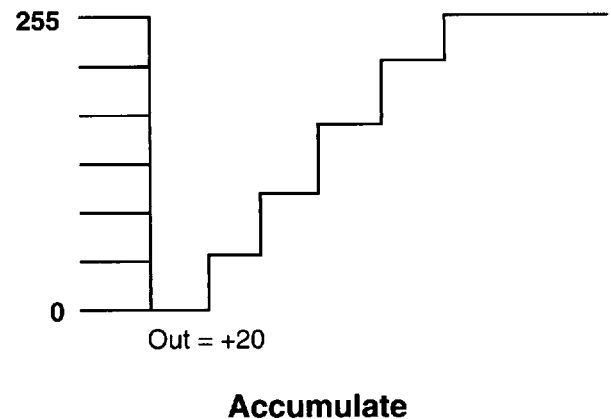

Figure 7. Accumulate Defuzzification.

Appendix A

Developing a Fuzzy Logic Control System

With the AL220's unique hardware approach to Fuzzy Logic, and the easy to use INSIGHT IIe development system, circuit designers need only a minimum understanding of Fuzzy Logic. This section briefly describes a typical design procedure and discusses how the AL220 device operates.

Example Circuit Description:

Figure 8 shows a simple circuit for evaluating the operation of the AL220. The circuit implements a closed loop controller based on a light and photo transistor. This design can be applied to many closed loop application such as heater or motor control. Contact Adaptive Logic for other detailed AL220 application notes.

The AL220 controls the current to the lamp, through the 2N2222 transistor driver, to regulate the amount of light reaching the OP550 photo transistor. A 10K potentiometer connected to one of the AL220 inputs is used to select the desired brightness.

The resistor R3 and capacitor C1 determine the internal clock generator frequency. R5, C3 and diode D1 provide for power up reset. Capacitor C2 decouples the AL220 analog reference and C4 decouples the power supply.

Membership Functions

With Fuzzy Logic the model for a problem does not need to be expressed mathematically. Instead they are contained in a linguistic description of the problem. This description is organized as Membership Functions and Rules. Membership Functions are used to segregate the input data into groups. For example, the signal from the photo transistor could be compared with the

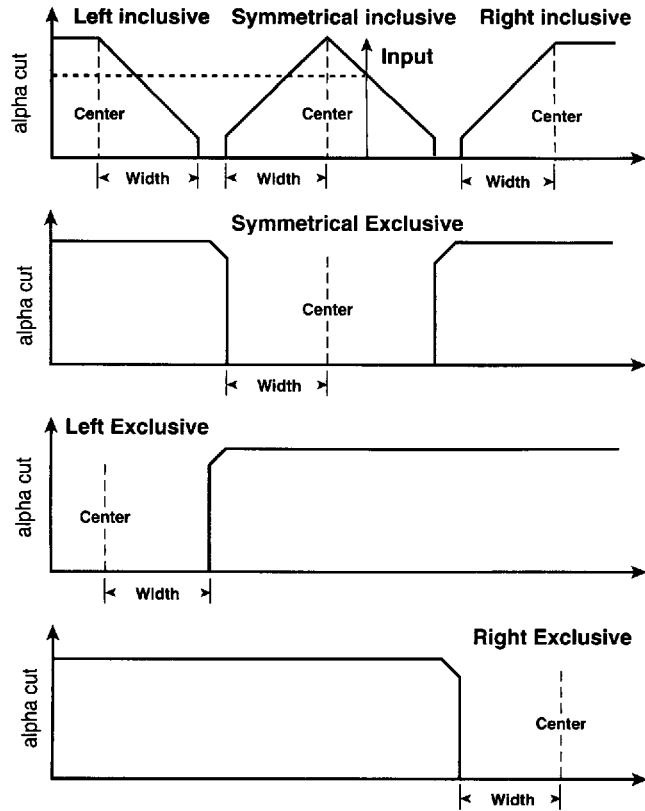

Figure 9. Membership Function Options with the AL220.

signal from the potentiometer and segmented accordingly. Several Membership Functions such as, Very Low, Low, Target, High, and Very High could be used to express the difference between the two signals. Linguistically this would be expressed as a Term, or Fuzzy Variable, taking the form of "Bright is High," where Bright is the input from the photo transistor and High is a Membership Function.

Membership Functions, shown in figure 9, are defined as containing a Width, Center, and Type or shape. The Center variable places the Membership Function at a particular location on the input number line. A Membership Function's Width determines how similar to the Center an input can be and still be considered a part of that Membership Function. Both the Center and Width variables may be fixed values or made to Float by obtaining the values from other inputs or outputs. This FLOATING MEMBERSHIP Function is useful for making quick general comparison and for tracking the relationship between two signals (see figure 10). We will use FLOATING MEMBERSHIP Functions to compare the desired brightness level with the actual level.

The Type or shape of a Membership Function may be chosen to cover the indicated range effectively. The AL220 supports six different Membership Function types. These types are shown in Figure 9. They consist

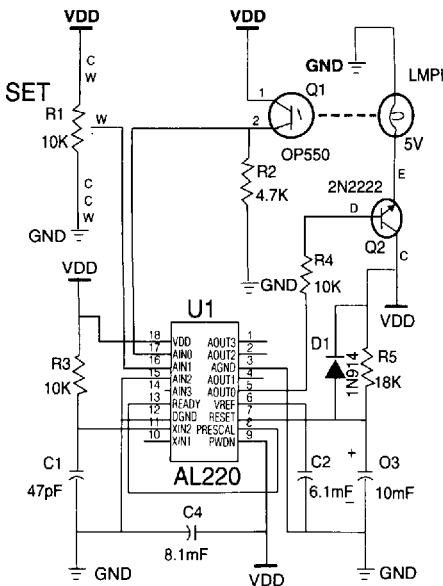

Figure 8. Closed Loop Controller Circuit

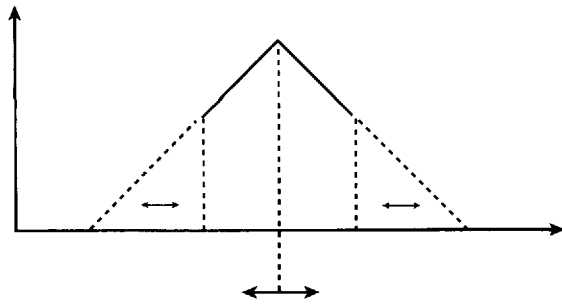

Figure 10. Floating Membership Functions.

of Left, Right, and Symmetrical Inclusive and Exclusive types. These six basic shapes can also be combined to create membership function types to solve most control problems.

Rules

Rules combine one or more Terms with an action or response and are written as If...Then statements, such as,

Inputs (Lamp) Bright Set
Outputs Lamp
Fuzzy Variables Lamp is LowLimit (90, 0, Left Inclusive) Lamp is HiLimit (200, 0, Right Inclusive) Bright is target (Set, 2, Symmetric Inclusive) Bright is low (Set, 2, Right Exclusive) Bright is high (Set, 2, Left Exclusive) Bright is vlow (Set, 5, Left Exclusive) Bright is vlow3 (Set, 5, Right Exclusive)
Rules If Lamp is LowLimit then Lamp = 91 If Lamp is HiLimit then Lamp = 199 If Bright is target then Lamp + 0 If Bright is vlow then Lamp + 2 If Bright is low then Lamp + 1 If Bright is vhigh then Lamp + -2 If Bright is high then Lamp + -1

Figure 11. Control Model: Inputs, Outputs, Variables and Rules

If Bright is High then Modify Output.

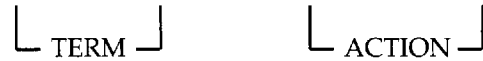

Each used output must have at least one Rule associated with it. Generally, several Rules are used to control each output.

The Action part of the Rule can take one of two forms. An Immediate Action copies an absolute value to the output. This value can come from another input, output, or from a fixed constant in memory. An Accumulating Action adds or subtracts the value from the present output. In this way integral functions can be implemented.

Fuzzy Model Description:

The INSIGHT Iie Fuzzy Model listing is shown in Figure 11. This listing, which defines how the AL220 will operate, is automatically generated by the INSIGHT Iie development system as the design is entered through the graphical tools.

The example uses two physical inputs, "Set," from the potentiometer, and "Bright" from the photo transistor. One output, "Lamp," is used to provide an analog drive to the lamp. The output, "Lamp," is also fed back to be used as an additional input. In this example we use the Lamp signal as an input to ensure that our controller always stays within predefined limits.

The Fuzzy Variables section of Figure 11 lists all of the Terms in the following format.

Input is *Membership Function* (Center, Width, Membership Function Type)

The first Term, "Lamp is LowLimit," uses a Fixed Center, "90," with a Fixed Width of 0 and a Membership Function Type of Right Exclusive. Therefore this Membership Function starts at 90 and cover all numbers less than 90. The third Term, "Bright is target," uses a Floating Center, "Set," with a Width of 2, and a Symmetric Inclusive function. This Membership Function will be centered at a number determined by the potentiometer setting, and have a width of 2 counts on either side of the center.

Figure 12 illustrates all of the Membership Functions selected for this example.

The last section of the Fuzzy Model listing describes the Rules. The first two rules are used to ensure that the controller never tries to set the Lamp to a value outside of our defined limits of 90 to 200. Since rules are evaluated in the priority that they are listed, we show these rules first. If the output Lamp belongs to the Membership Function "LowLimit," which is any number less than or equal to 90, then the output will be forced back to 91 by the Immediate Action "= 91." The second rule controls the high limit in a similar way.

The remaining rules all compare the photo transistor, "Bright," with the potentiometer, "Set," and determine if they compare, or if not, how close they are

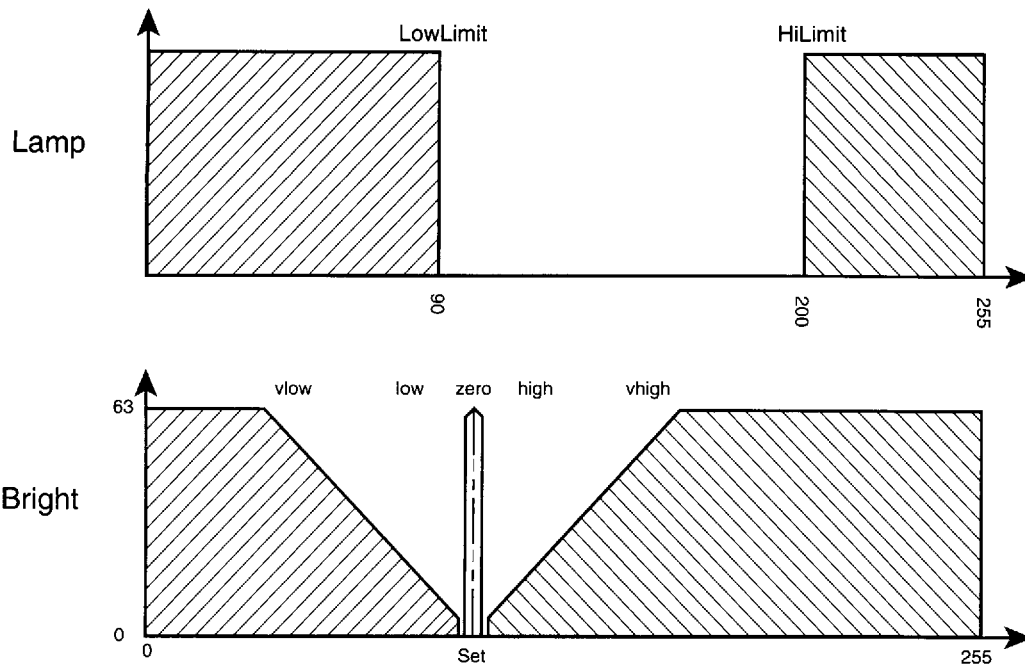

Figure 12. Control Model Membership Functions.

to each other. If they do compare, "Bright is zero," no change is made to the output. If they do not compare, the output is either incremented or decremented until a match is reached.

All of the rules are evaluated every processor cycle, which is 1024 clocks. Even at the slowest speeds for the AL220, this output update rate may be too fast for some applications. For example, the AL220 might tell the Lamp to get brighter, but because it takes the filament and the photo transistor some time to respond, the AL220 might have already sampled the input again

and determined that nothing happened. The AL220 would respond by further incrementing the output to make the Lamp brighter. When the system finally does respond it might be too bright and the AL220 would need to decrement the output. This kind of operation can easily lead to drastic over and under shoots or oscillations.

The AL220 has a feature called PRESCALE, which effectively slows the update rate of the processor down. In this example we chose a prescale value that results in an output

update rate of 15ms. (see page 4 prescaled operation).

The attached timing diagrams (Figure 13) illustrate the response of this simple controller. The numbers on the Y-Axis represent the amplitude of the output and variables. The X-Axis numbers represent sample times and can only be related to real time if the speed of the Fuzzy Logic controller is known. For this example the numbers could represent 15 milliseconds each.

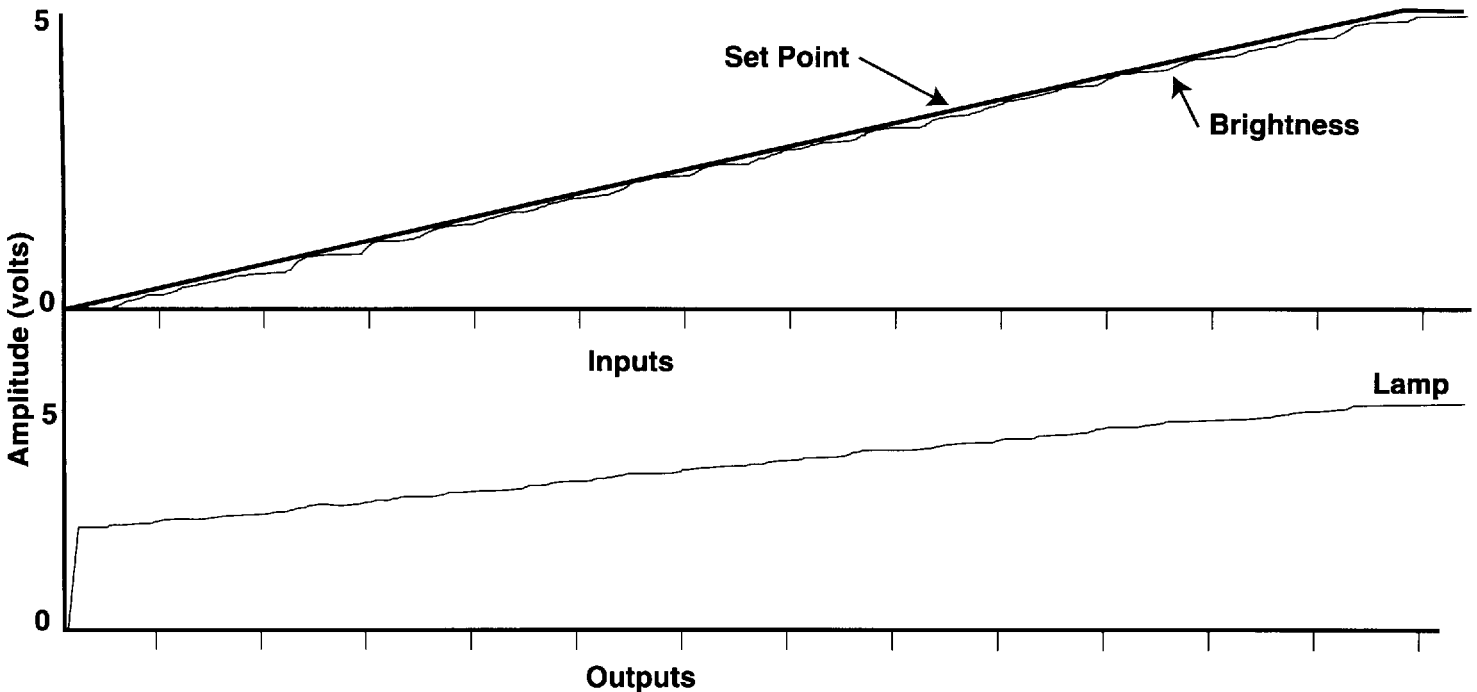

Figure 13. Timing Response of Control Model.

Appendix B

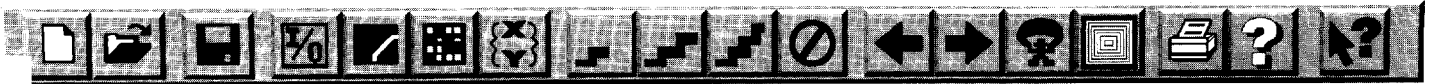

Figure 14. INSIGHT Iie Icon Tool Bar.

INSiGHT Iie





With Windows-based INSiGHT Iie, it's a breeze to enter, simulate, and compile your AL220 design. The handy pull-down menus make entry as simple as pressing a button. The simulator allows you to analyze your design down to the last input and membership function. You can force any input, output, variable, or rule to a constant to rapidly isolate and debug problems. Additionally, with the Mathematical Equation Editor, inputs can be derived from output functions, thus creating a closed loop simulation. Results can be viewed graphically, in a matrix, or alphanumerically.













With the Fuzzy Model Editor, you create and edit models of the system you want to control. The INSiGHT Iie Input Editor allows you to easily construct input data files to be used during simulations. With the INSiGHT Iie Fuzzy Logic simulator, you use your fuzzy logic models and input files to run simulations. The INSiGHT Iie Simulator generates simulation output files. Using the INSiGHT Iie Output Viewer, you analyze the simulation output files to fine-tune your fuzzy logic models. Finally, you use the INSiGHT Iie compiler and programmer to program the fuzzy logic controller, or the real time hardware emulator to get your design up and running fast.

INSiGHT Iie Tool Bar

Near the top of the INSiGHT Iie window (under the menu bar) is a tool bar. The tool bar is a shortcut for frequently used menu items (figure 14).

The INSiGHT Iie Tool Bar

-  The **New** icon allows you to create a new model.
-  The **Open** icon brings up the File Open dialog box. Previously saved files can be selected for loading.
-  The **Save** icon saves the current open model.
-  The **Edit Inputs/Outputs** icon opens the Edit Inputs/Outputs dialog box.
-  The **Edit Fuzzy Variables** icon opens the Edit Fuzzy Variables dialog box. This function allows you to define the membership functions.

-  The **Edit Rules** icon opens the Edit Rules dialog box, where you construct the rules controlling the outputs of the fuzzy control system.
-  The **Equation** icon calls up the equation dialog box in which equations can be entered to represent inputs as functions of simulated outputs. There is no limit to the number of equations that can be entered and the editor includes a complete set of math operands such as Sin, Cos, Log, etc. functions.
-  The **Next Rule** icon processes the next rule in the model.
-  The **Next Frame** icon processes the next complete simulation frame.
-  The **Continuous** icon processes inputs continuously until the input source is exhausted.
-  The **Stop** icon interrupts a running simulation.
-  The **Move Backward** icon is used in the output viewer to move the time window backward to display earlier simulation frames.
-  The **Move Forward** icon is used in the output viewer to move the time window forward to display later simulation frames.
-  The **Jump** icon will cause the output viewer to jump to a specified frame.
-  The **Zoom** icon opens the Zoom Factor dialog box to adjust the size of the time window while in the output viewer. For example, if you want to see every simulation frame's results, enter a 1 for the zoom factor. If you want to see every 10th frame, enter a 10 for the zoom factor.
-  The **Print** icon prints the current screen.
-  The **About** icon displays an "About" box, that shows the version of INSiGHT Iie you are running.
-  The **Help** icon places INSiGHT Iie in a context-sensitive help mode. When this icon is pressed, the cursor changes to match the icon. The next item selected from the menus for the tool bar brings up a Help message for that item.

Appendix C

Package Details

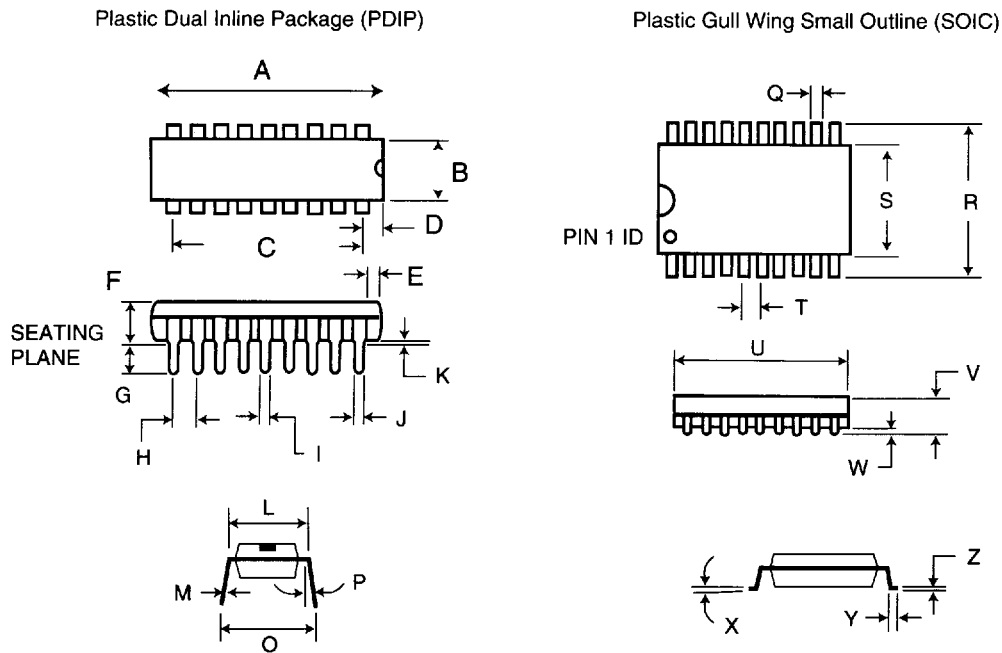

Figure 15. Package Mechanical Details.

All dimensions in mils

- | | |
|------------------------|-------------------------|
| A- 900 ±10 | Q- 20 (Max)/13 (Min) |
| B- 500 ±10 | R- 402 (TYP) |
| C- 800 (TYP) | S- 296 (TYP) |
| D- 50 (TYP) | T- 50 (TYP) |
| E- 20 (TYP) | U- 606 |
| F- 120 (TYP) | V- 100 (Max)/88 (Min) |
| G- 150 (Max)/125 (Min) | W- 11.5 (Max)/4 (Min) |
| H- 100 (TYP) | X- 5° |
| I- 18 (TYP) | Y- 50 (Max)/16 (Min) |
| J- 60 (TYP) | Z- 12.5 (Max)/9.1 (Min) |
| K- 15 (Min) | |
| L- 310±15 | |
| M- 10(TYP) | |
| O- 350 ±60 | |
| P- 7° (TYP) | |

Appendix D

Ordering Information

Prefix	Device	Suffix
AL	220	X X X

Temperature Range
C = Commercial (0° to 70°)

Package
P = Plastic 18 pin DIP
S = 20 lead SOIC

Options
R = RC Oscillator
C = Crystal Oscillator

Example:

AL220-RPC - Temperature

Option Designator Package

7/95