

**Receive I/Q Module Using High Barrier Schottky Mixers
850 - 960 MHz**

**MAIA-007775-000100
V3**

Features

- Excellent Carrier Suppression ~36 dBc
- Sideband Suppression ~37 dBc
- +2 to +8 dBm LO Drive
- Excellent ACPR ~77 dBc
- Low Output Noise Floor ~161 dBm/Hz
- Phase Balance < 2.5 deg
- Lead-Free 6 x 6 mm PQFN Package
- 100% Matte Tin Plating over Copper
- Halogen-Free "Green" Mold Compound
- 260°C Reflow Compatible
- RoHS Compliant

Description

M/A-COM's MAIA-007775-000100 is a glass / silicon monolithic 850-960MHz, I/Q Modulator/Demodulator. Encapsulated in a low cost, miniature surface mount PQFN 6mm square, 28-lead plastic package, the die utilizes M/A-COM's unique HMIC silicon/glass and GaAs processes. The product performance maximizes the advantages provided by both processes through the realization of low loss passive elements and efficient diode technology. The net result provides excellent harmonic suppression and output noise performance. In addition, the incorporated monolithic design techniques provide unparalleled amplitude and phase balance performance during demodulation thus adding to the unit's overall versatility.

Applications

These modulators/demodulators are well suited for GSM and CDMA Cellular base station applications, as well as most RFID systems, particularly where small size and high performance are required. Typical applications include quadrature modulation requirements in wireless receivers and transmitters.

Ordering Information

Part Number	Package
MAIA-007775-000100	Bulk Packaging
MAIA-007775-0001TR	1000 piece reel
MAIA-007775-0001TB	Sample Test Board

Note: Reference Application Note M513 for reel size information.

Note: Die quantity varies.

Functional Block Diagram

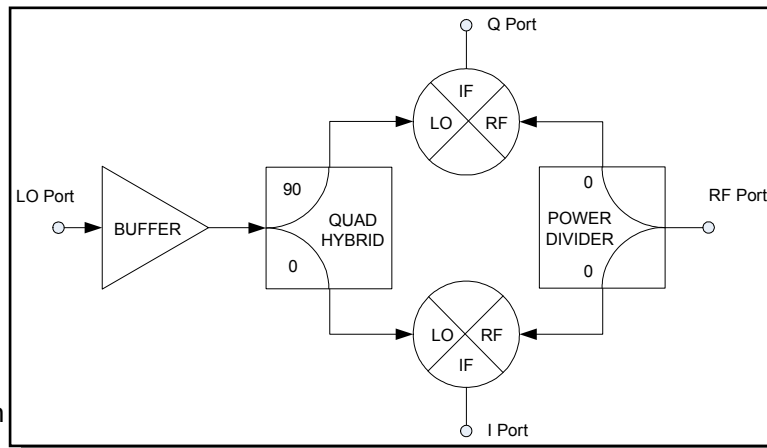

Pin Configuration

Pin No.	Function	Pin No.	Function
1	VCC	15	GND
2	GND	16	GND
3	GND	17	GND
4	LO	18	RF
5	GND	19	GND
6	GND	20	GND
7	GND	21	GND
8	GND	22	GND
9	GND	23	GND
10	GND	24	GND
11	I	25	Q
12	GND	26	GND
13	GND	27	GND
14	GND	28	GND

The exposed pad centered on the package bottom must be connected to RF and DC ground. (For PQFN Packages)

* Restrictions on Hazardous Substances, European Union Directive 2002/95/EC.

- **North America** Tel: 800.366.2266 / Fax: 978.366.2266
- **Europe** Tel: 44.1908.574.200 / Fax: 44.1908.574.300
- **Asia/Pacific** Tel: 81.44.844.8296 / Fax: 81.44.844.8298

Visit www.macom.com for additional data sheets and product information.

**Receive I/Q Module Using High Barrier Schottky Mixers
850 - 960 MHz**

**MAIA-007775-000100
V3**

Electrical Specifications (Modulator): $T_A = 25^\circ\text{C}$, $Z_0 = 50\Omega$, $V_{CC} = +5.0\text{V}$

Parameter	Test Conditions	Frequency	Units	Min	Typ	Max
LO Input Power	-	-	dBm	2	-	8
I, Q Input Power	-	-	dBm	-	-	10
Output Power	LO Drive = +4 dBm I/Q = -7 dBm, I/Q = 400 kHz $F_{RF} = F_{LO} - 0.4 \text{ MHz}$	900 MHz 850-960 MHz	dBm dBm	-15.0 -15.5	-14 -14	- -
LO Carrier Suppression	LO Drive = +4 dBm I/Q = -7 dBm, I/Q = 400 kHz $F_{RF} = F_{LO} - 0.4 \text{ MHz}$	850-960 MHz	dBc	30	36	-
SSB Rejection ¹	LO Drive = +4 dBm I/Q = -7 dBm, I/Q = 400 kHz $F_{RF} = F_{LO} + 0.4 \text{ MHz}$	850-960 MHz	dBc	29	37	-
3 x 1 Harmonic Suppression	LO Drive = +4dBm I/Q = -7 dBm, I/Q = 400 kHz $F_{RF} = F_{LO} + 1.2 \text{ MHz}$	850-960 MHz	dBc	56	68	-
5 x 1 Harmonic Suppression	LO Drive = +4 dBm I/Q = -7 dBm, I/Q = 400 kHz $F_{RF} = F_{LO} + 2.0 \text{ MHz}$	850-960 MHz	dBc	82	88	-
ACPR CDMA 2000 ²	LO Drive = +4 dBm BB AC Voltage = 275 mVp-p	900 MHz Carrier Freq	dBc	-	77	-
Output Noise Floor	LO Drive = +4 dBm, I/Q = -7 dBm Freq offset = 20 MHz	850-960 MHz	dBm/Hz	-	-160	-
IF Bandwidth	$850 \text{ MHz} \leq \text{LO} \leq 970 \text{ MHz}$	-	MHz	65	-	-
LO Return Loss	LO Drive = +4 dBm $F_{RF} = F_{LO} + 0.4 \text{ MHz}$	850-960 MHz	dB	-	8	-
RF Return Loss	LO Drive = +4 dBm RF Input = -7 dBm $F_{RF} = F_{LO} + 0.4 \text{ MHz}$	850-960 MHz	dB	-	9	-
Supply Voltage	VCC	-	V	4.5	5.0	5.5
Supply Current	ICC	Typical @ 25°C	mA	50	75	100

1. When the LO frequency is greater than the RF frequency, the upper sideband is suppressed.
2. The Baseband I and Q input signals were generated using the following settings in the Agilent E3844C Vector Signal Generator:

FWD CDMA2000 SR1 Pilot
Filter: IS-95 Mod w/EQ
Link: Forward
IQ Mod Filter: Through
PRE Clip: 100.0 %

**Receive I/Q Module Using High Barrier Schottky Mixers
850 - 960 MHz**

**MAIA-007775-000100
V3**

Electrical Specifications (Demodulator): $T_A = 25^\circ\text{C}$, $Z_0 = 50\Omega$, $V_{CC} = +5.0\text{V}$

Parameter	Test Conditions	Frequency	Units	Min	Typ	Max
LO Input Power	-	-	dBm	2	-	8
Conversion Loss	LO Drive = +4 dBm RF Input = -7 dBm $F_{RF} = F_{LO} + 0.4 \text{ MHz}$	900 MHz 850-960 MHz	dB dB	13 13.5	12 12.5	- -
Amplitude Imbalance	LO Drive = +4 dBm RF Input = -7 dBm $F_{RF} = F_{LO} + 0.4 \text{ MHz}$	850-960 MHz	dB	-	0.1	0.2
Phase Imbalance ³	LO Drive = +4 dBm RF Input = -7 dBm $F_{RF} = F_{LO} + 0.4 \text{ MHz}$	850-960 MHz	deg	-	0.5	2.5
Input IP3	LO Drive = +4 dBm RF Input = -7 dBm (each tone) Tone 1 is 10 MHz above LO Freq Tone 2 is 11 MHz above LO Freq	850-960 MHz	dBm	28.5	32	-
1 dB Compression Point	LO Drive = +4 dBm $F_{RF} = F_{LO} + 0.4 \text{ MHz}$	850-960 MHz	dBm	14.5	15.5	-
IF Bandwidth	$850 \text{ MHz} \leq \text{LO} \leq 970 \text{ MHz}$ $F_{RF} = F_{LO} + F_{IF}$; $0 \leq F_{IF} \leq 65 \text{ MHz}$	-	MHz	65	-	-
LO Return Loss	LO Drive = +4 dBm RF Input = -7 dBm $F_{RF} = F_{LO} + 0.4 \text{ MHz}$	850-960 MHz	dB	-	8	-
RF Return Loss	LO Drive = +4 dBm RF Input = -7 dBm $F_{RF} = F_{LO} + 0.4 \text{ MHz}$	850-960 MHz	dB	-	9	-
Supply Voltage	VCC	-	V	4.5	5.0	5.5
Supply Current	ICC	Typical @ 25°C	mA	50	75	100

3. When the LO frequency is greater than the RF frequency, the “Q” output leads the “I” output by 90 degrees nominal.

**Receive I/Q Module Using High Barrier Schottky Mixers
850 - 960 MHz**

**MAIA-007775-000100
V3**

Electrical Specifications (Modulator): $T_A = 25^\circ\text{C}$, $Z_0 = 50\Omega$, $V_{CC} = +3.3\text{V}$

Parameter	Test Conditions	Frequency	Units	Min	Typ	Max
LO Input Power	-	-	dBm	2	-	8
I, Q Input Power	-	-	dBm	-	-	10
Output Power	LO Drive = +4 dBm I/Q = -7 dBm, I/Q = 400 kHz $F_{RF} = F_{LO} - 0.4 \text{ MHz}$	900 MHz 850-960 MHz	dBm dBm	- -	-14 -14	- -
LO Carrier Suppression	LO Drive = +4 dBm I/Q = -7 dBm, I/Q = 400 kHz $F_{RF} = F_{LO} - 0.4 \text{ MHz}$	850-960 MHz	dBc	-	35	-
SSB Rejection ¹	LO Drive = +4 dBm I/Q = -7 dBm, I/Q = 400 kHz $F_{RF} = F_{LO} + 0.4 \text{ MHz}$	850-960 MHz	dBc	-	30	-
3 x 1 Harmonic Suppression	LO Drive = +4dBm I/Q = -7 dBm, I/Q = 400 kHz $F_{RF} = F_{LO} + 1.2 \text{ MHz}$	850-960 MHz	dBc	-	68	-
5 x 1 Harmonic Suppression	LO Drive = +4 dBm I/Q = -7 dBm, I/Q = 400 kHz $F_{RF} = F_{LO} + 2.0 \text{ MHz}$	850-960 MHz	dBc	-	88	-
Output Noise Floor	LO Drive = +4 dBm, I/Q = -7 dBm Freq offset = 20 MHz	850-960 MHz	dBm/Hz	-	-160	-
IF Bandwidth	$850 \text{ MHz} \leq \text{LO} \leq 970 \text{ MHz}$	-	MHz	65	-	-
LO Return Loss	LO Drive = +4 dBm $F_{RF} = F_{LO} + 0.4 \text{ MHz}$	850-960 MHz	dB	-	7.5	-
RF Return Loss	LO Drive = +4 dBm RF Input = -7 dBm $F_{RF} = F_{LO} + 0.4 \text{ MHz}$	850-960 MHz	dB	-	8.5	-
Supply Voltage	VCC	-	V	2.85	3.3	3.6
Supply Current	ICC	Typical @ 25°C	mA	-	60	-

**Receive I/Q Module Using High Barrier Schottky Mixers
850 - 960 MHz**

**MAIA-007775-000100
V3**

Electrical Specifications (Demodulator): $T_A = 25^\circ\text{C}$, $Z_0 = 50\Omega$, $V_{CC} = +3.3\text{V}$

Parameter	Test Conditions	Frequency	Units	Min	Typ	Max
LO Input Power	-	-	dBm	2	-	8
Conversion Loss	LO Drive = +4 dBm RF Input = -7 dBm $F_{RF} = F_{LO} + 0.4 \text{ MHz}$	900 MHz 850-960 MHz	dB dB	- -	12.5 12.5	- -
Amplitude Imbalance	LO Drive = +4 dBm RF Input = -7 dBm $F_{RF} = F_{LO} + 0.4 \text{ MHz}$	850-960 MHz	dB	-	0.1	0.2
Phase Imbalance ³	LO Drive = +4 dBm RF Input = -7 dBm $F_{RF} = F_{LO} + 0.4 \text{ MHz}$	850-960 MHz	deg	-	2.5	-
Input IP3	LO Drive = +4 dBm RF Input = -7 dBm (each tone) Tone 1 is 10 MHz above LO Freq Tone 2 is 11 MHz above LO Freq	850-960 MHz	dBm	-	32	-
1 dB Compression Point	LO Drive = +4 dBm $F_{RF} = F_{LO} + 0.4 \text{ MHz}$	850-960 MHz	dBm	-	15.5	-
IF Bandwidth	$850 \text{ MHz} \leq \text{LO} \leq 970 \text{ MHz}$ $F_{RF} = F_{LO} + F_{IF}$; $0 \leq F_{IF} \leq 65 \text{ MHz}$	-	MHz	65	-	-
LO Return Loss	LO Drive = +4 dBm RF Input = -7 dBm $F_{RF} = F_{LO} + 0.4 \text{ MHz}$	850-960 MHz	dB	-	7.5	-
RF Return Loss	LO Drive = +4 dBm RF Input = -7 dBm $F_{RF} = F_{LO} + 0.4 \text{ MHz}$	850-960 MHz	dB	-	8.5	-
Supply Voltage	VCC	-	V	2.85	3.3	3.6
Supply Current	ICC	Typical @ 25°C	mA	-	60	-

**Receive I/Q Module Using High Barrier Schottky Mixers
850 - 960 MHz**

**MAIA-007775-000100
V3**

Absolute Maximum Ratings^{4,5}

Parameter	Absolute Maximum
Operating Temperature	-40°C to +85°C
Storage Temperature	-65°C to +150°C
Incident LO Power	+15 dBm C.W.
Incident RF Power	+20 dBm C.W.
Supply Voltage (VCC)	-0.5V to 6.0V
Supply Current (ICC)	100 mA

4. Exceeding any one or combination of these limits may cause permanent damage to this device.
5. M/A-COM does not recommend sustained operation near these survivability limits.

Handling Procedures

Please observe the following precautions to avoid damage:

Static Sensitivity

Gallium Arsenide Integrated Circuits are sensitive to electrostatic discharge (ESD) and can be damaged by static electricity. Proper ESD control techniques should be used when handling these devices.

Recommended PCB Configuration

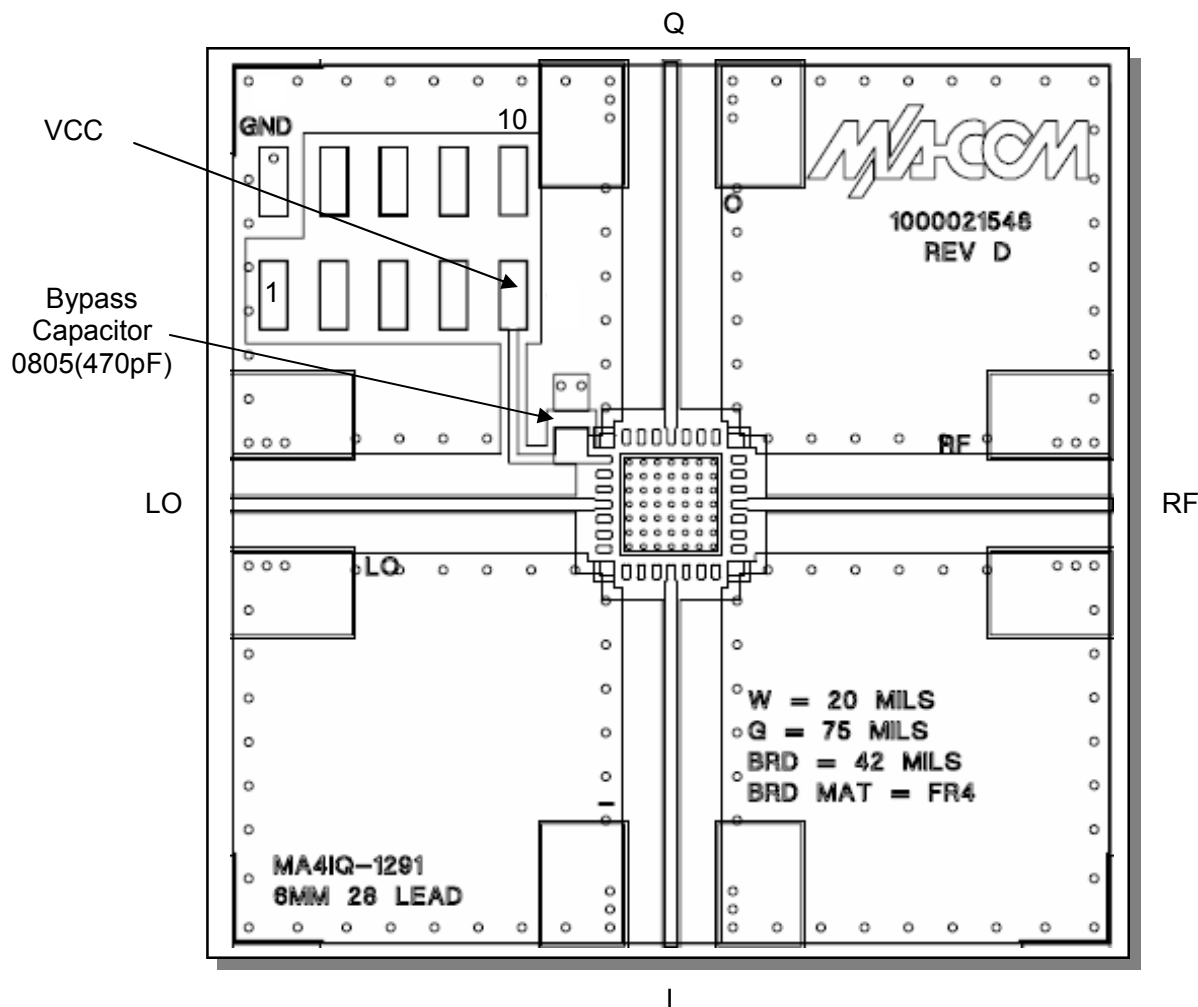

Typical Performance Curves @ VCC = +5.0V, +4 dBm LO Drive, 400 kHz C.W. I/Q

Harmonic and Carrier Suppression

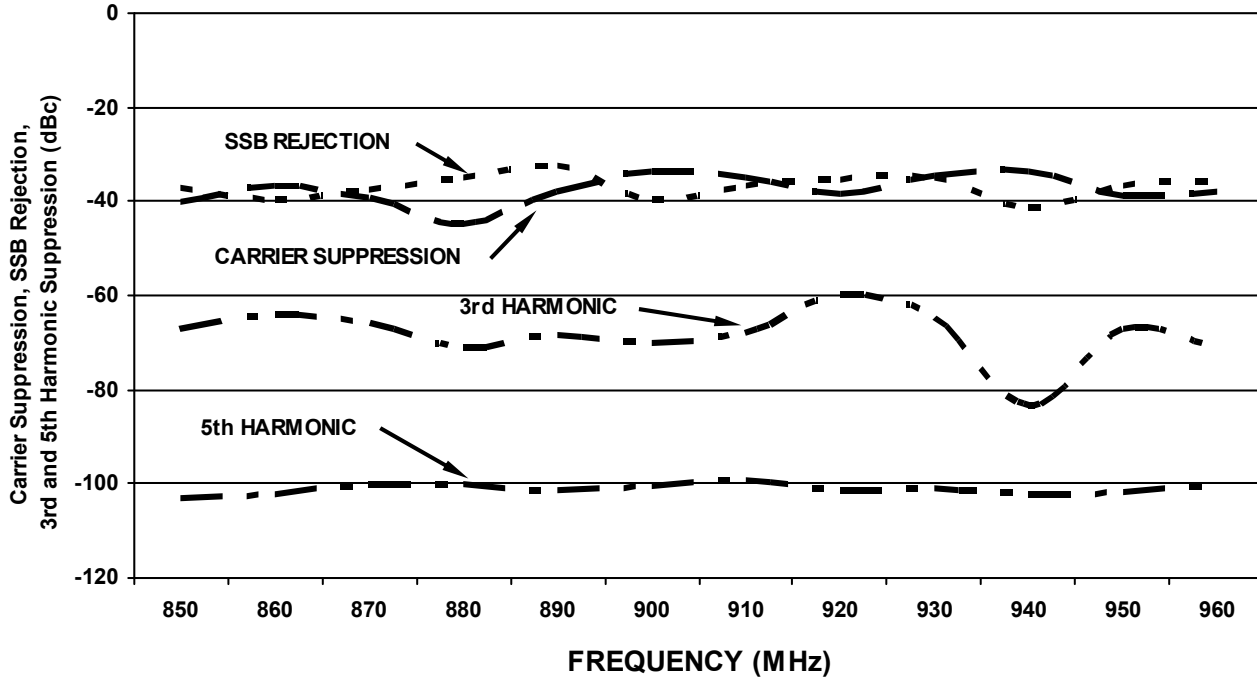

LO and RF Port Match

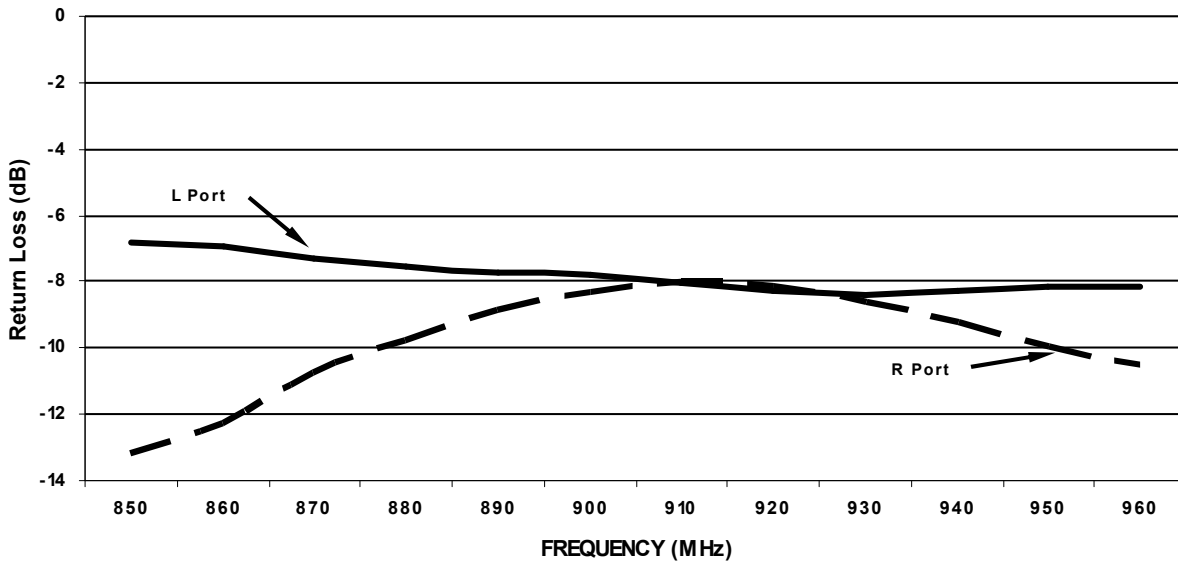

Typical Performance Curves @ VCC = +5.0V, +4 dBm LO Drive, 400 kHz C.W. I/Q

Input IP3 & 1 dB Compression Point

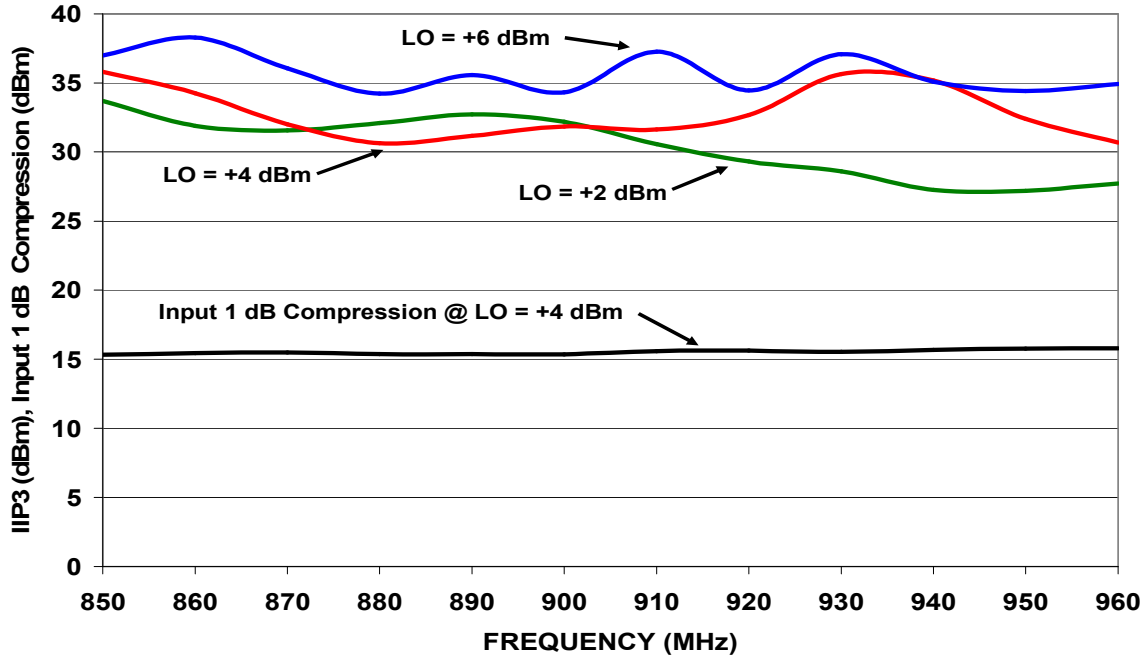

Output Noise Floor

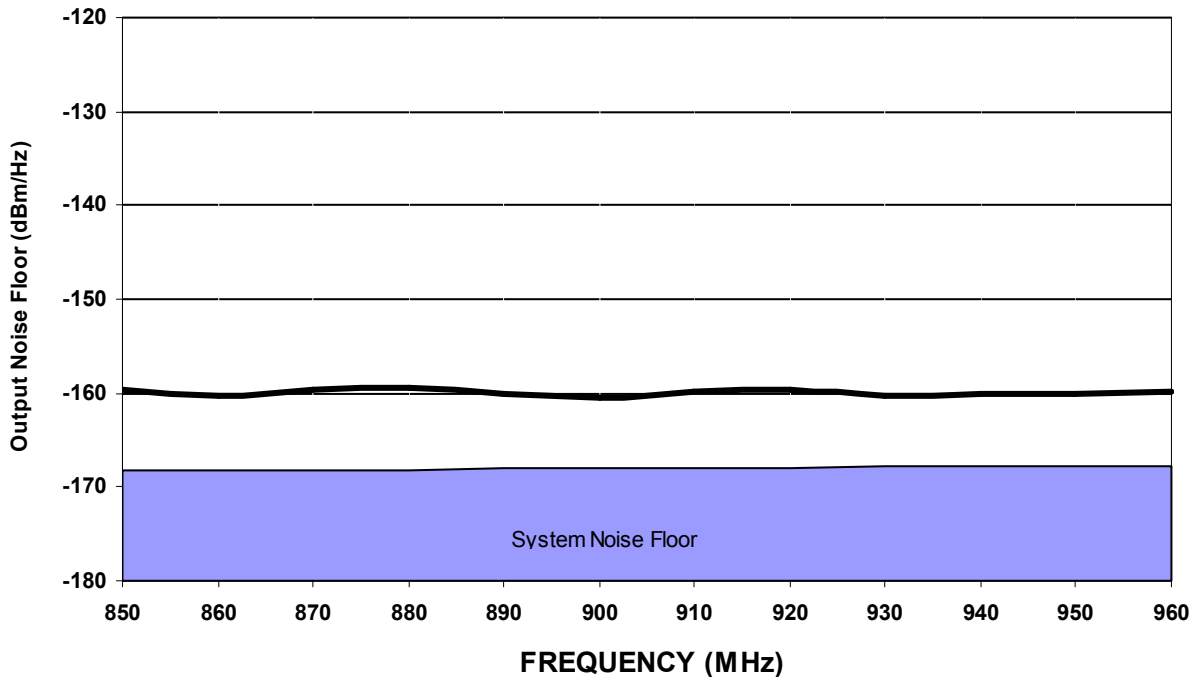

Typical Performance Curves @ Vcc = +5.0V, +4 dBm LO Drive, 400 kHz C.W. I/Q

Demodulator Amplitude Balance vs. LO Power

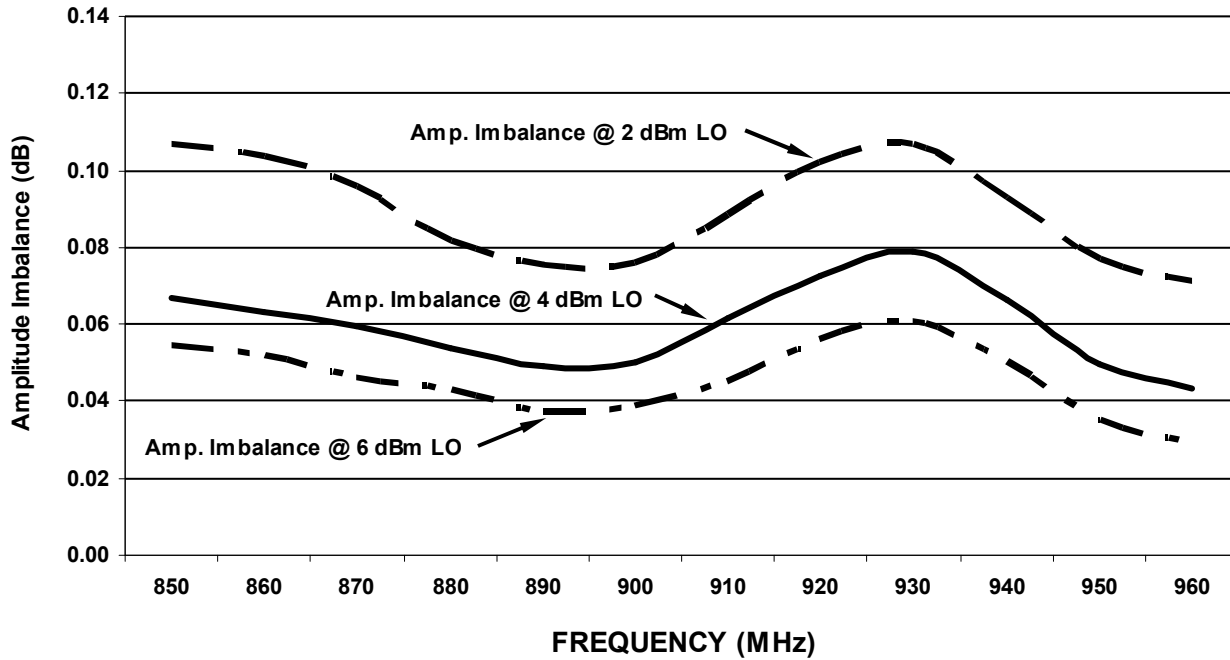

Demodulator Phase Balance vs. LO Power

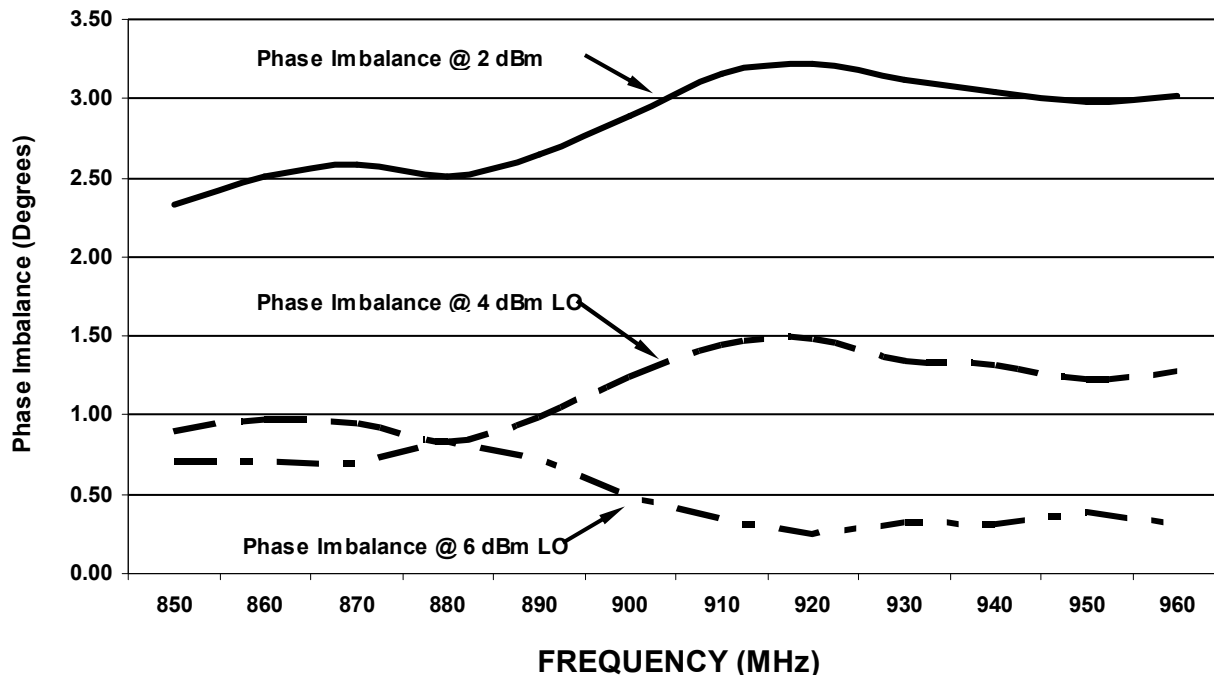

**Receive I/Q Module Using High Barrier Schottky Mixers
850 - 960 MHz**

**MAIA-007775-000100
V3**

Typical Performance Curves @ VCC = 5.0V, +4 dBm LO Drive

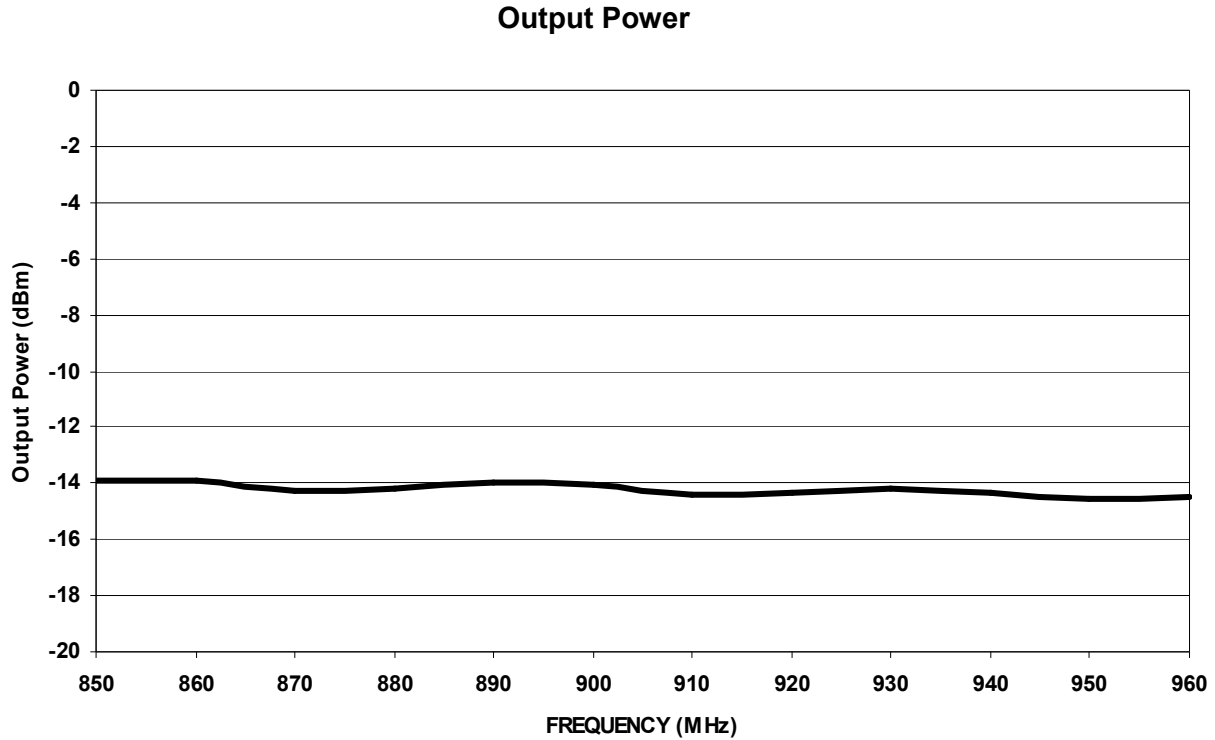

**Receive I/Q Module Using High Barrier Schottky Mixers
850 - 960 MHz**

**MAIA-007775-000100
V3**

Electrical Specifications: $T_A = 25^\circ\text{C}$, $Z_0 = 50\Omega$, $V_{CC} = +3.3\text{V}$

Conversion Loss vs. PLO: $V_{CC} = 3.3\text{V}$

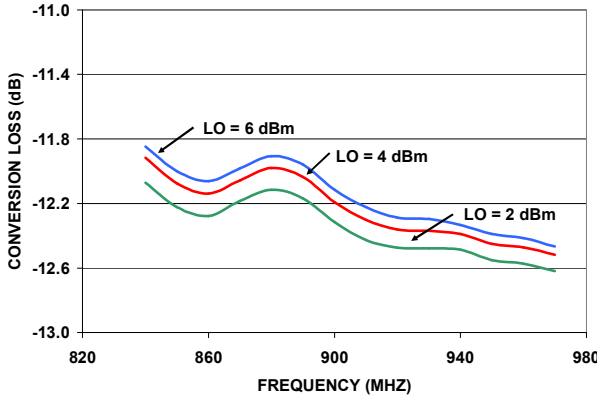

$P_{-1\text{dB}}$ vs. PLO: $V_{CC} = 3.3\text{V}$

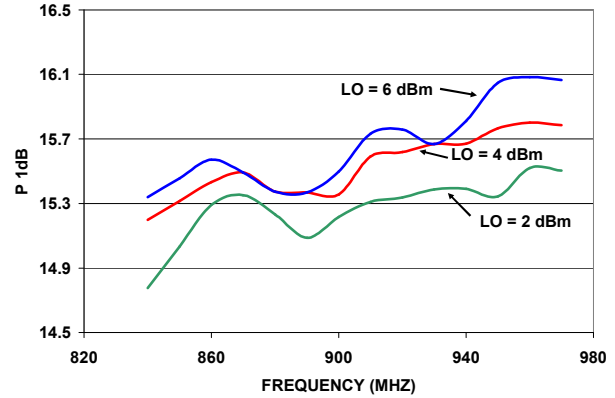

Amplitude Imbalance vs. PLO: $V_{CC} = 3.3\text{V}$

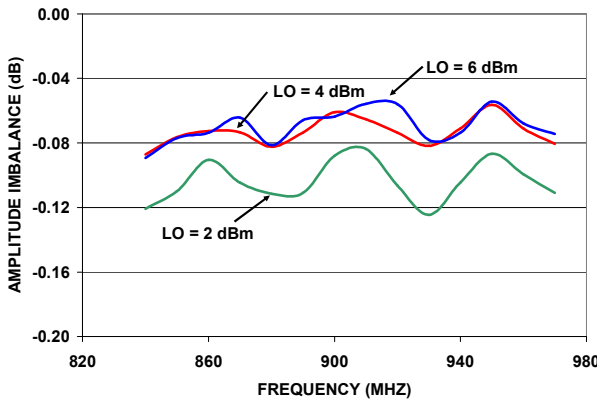

IIP3 vs. PLO: $V_{CC} = 3.3\text{V}$

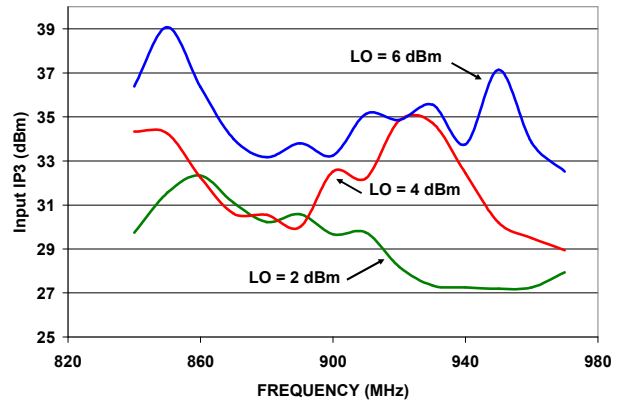

**Phase Error from Quadrature vs PLO:
 $V_{CC} = 3.3\text{V}$**

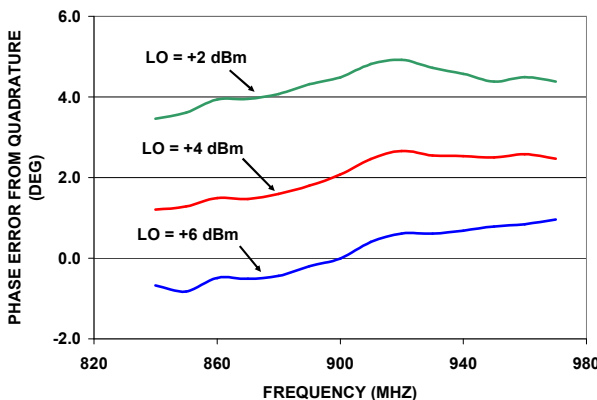

**Carrier Suppression, SSB Rejection,
3rd and 5th Harmonic Suppression:
 $V_{CC} = 3.3\text{V}$, PLO = +4 dBm**

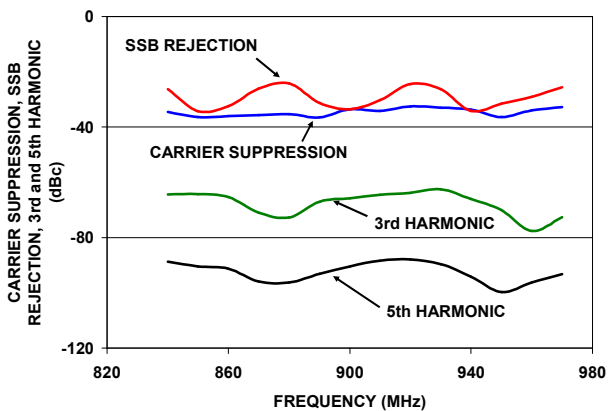

**Receive I/Q Module Using High Barrier Schottky Mixers
850 - 960 MHz**

**MAIA-007775-000100
V3**

Electrical Specifications: $T_A = 25^\circ\text{C}$, $Z_0 = 50\Omega$, $V_{CC} = +2.85\text{ V}$

Conversion Loss vs. PLO: $V_{CC} = 2.85\text{V}$

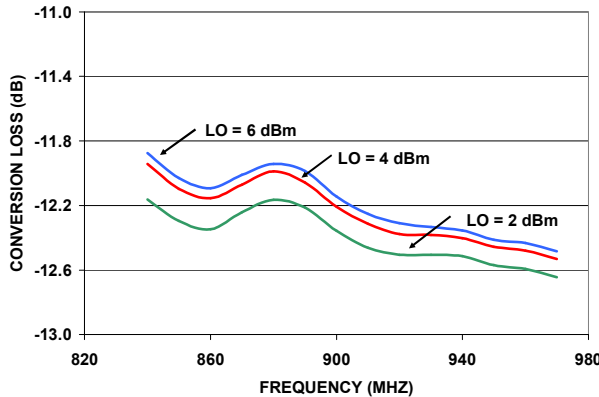

$P_{-1\text{dB}}$ vs. PLO: $V_{CC} = 2.85\text{V}$

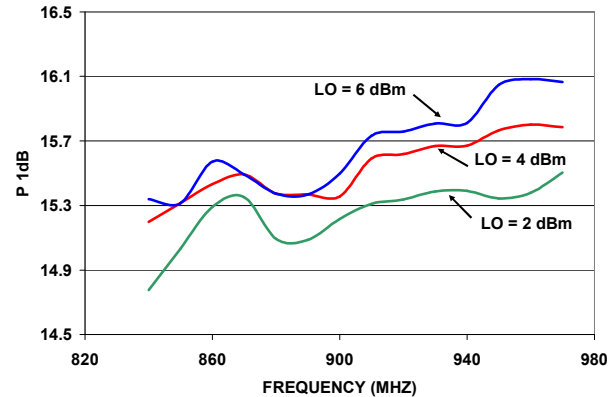

Amplitude Imbalance vs. PLO: $V_{CC} = 2.85\text{V}$

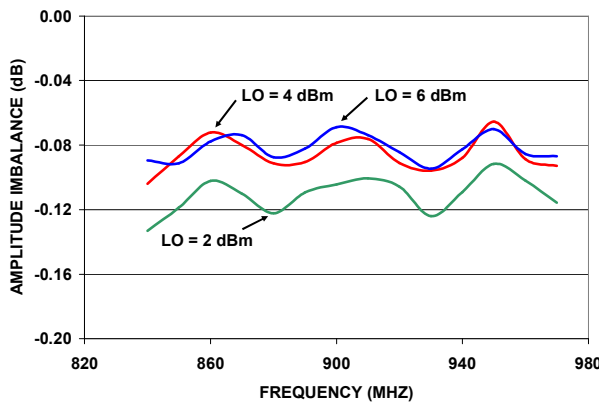

IIP3 vs. PLO: $V_{CC} = 2.85\text{V}$

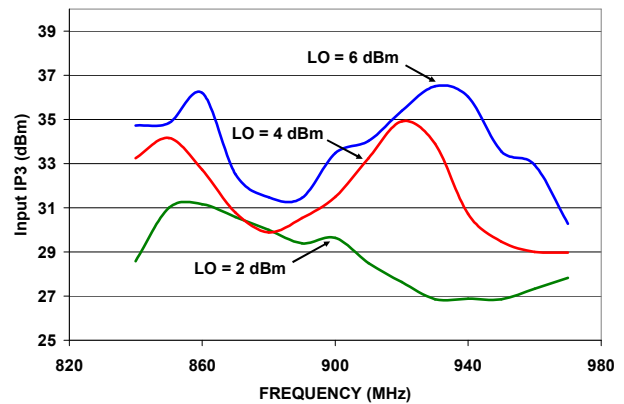

**Phase Error from Quadrature vs PLO:
 $V_{CC} = 2.85\text{V}$**

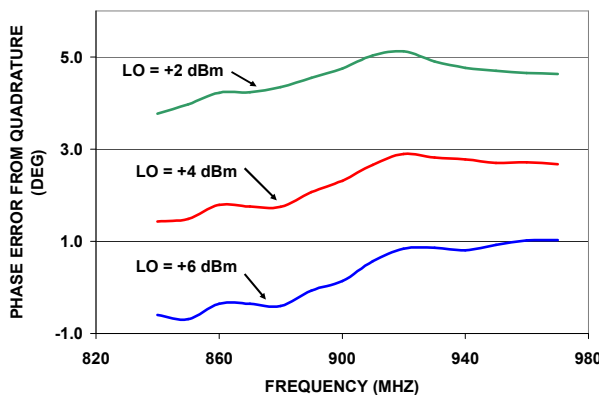

**Carrier Suppression, SSB Rejection,
3rd and 5th Harmonic Suppression:
 $V_{CC} = 2.85\text{V}$, $P_{LO} = +4\text{ dBm}$**

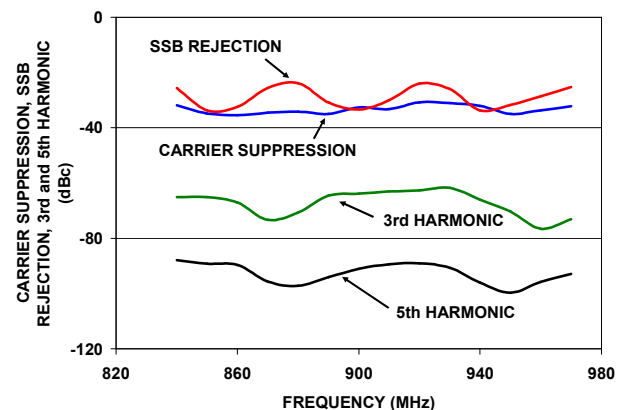

**Receive I/Q Module Using High Barrier Schottky Mixers
850 - 960 MHz**

**MAIA-007775-000100
V3**

Electrical Specifications: $T_A = 25^\circ\text{C}$, $Z_0 = 50\Omega$, $V_{CC} = +3.6\text{V}$

Conversion Loss vs. PLO: $V_{CC} = 3.6\text{V}$

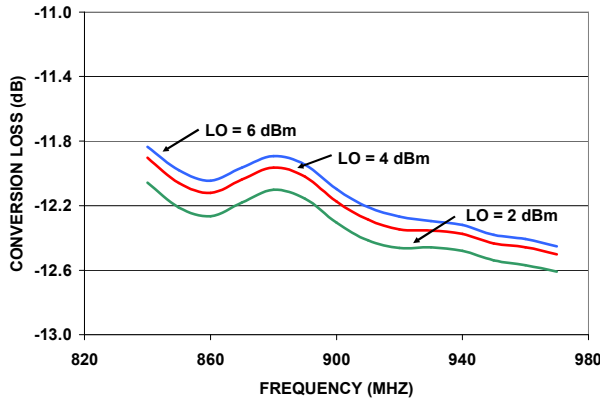

$P_{-1\text{dB}}$ vs. PLO: $V_{CC} = 3.6\text{V}$

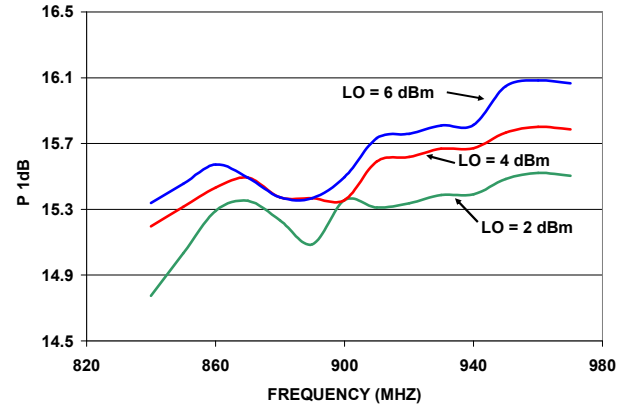

Amplitude Imbalance vs. PLO: $V_{CC} = 3.6\text{V}$

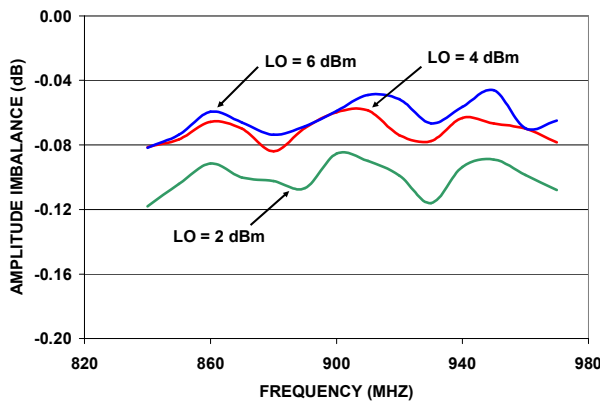

IIP3 vs. PLO: $V_{CC} = 3.6\text{V}$

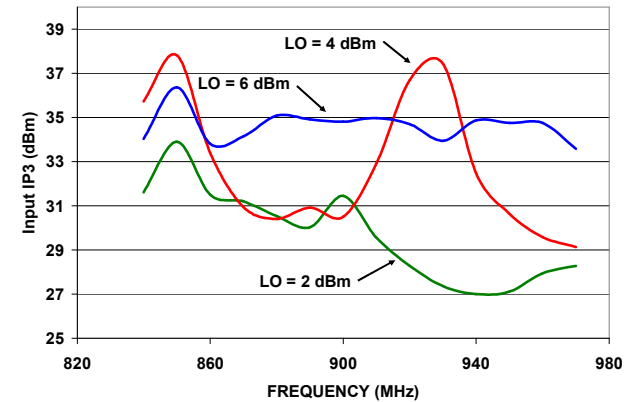

**Phase Error from Quadrature vs PLO:
 $V_{CC} = 3.6\text{V}$**

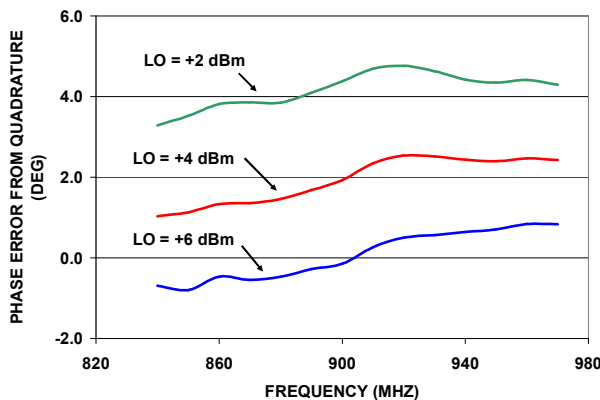

**Carrier Suppression, SSB Rejection,
3rd and 5th Harmonic Suppression:
 $V_{CC} = 3.6\text{V}$, PLO = +4 dBm**

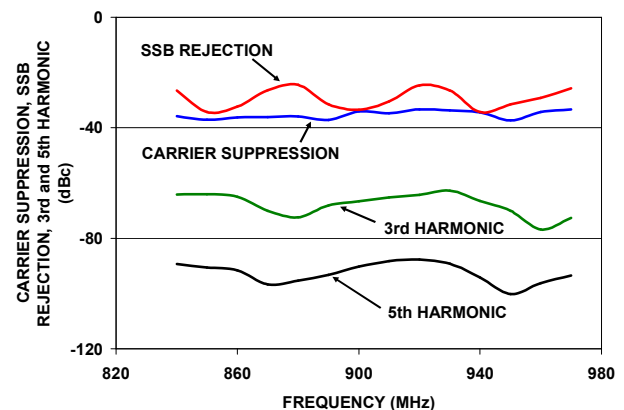

**Receive I/Q Module Using High Barrier Schottky Mixers
850 - 960 MHz**

**MAIA-007775-000100
V3**

Electrical Specifications: $T_A = 25^\circ\text{C}$, $Z_0 = 50\Omega$

I(VCC) vs. VCC AND PLO

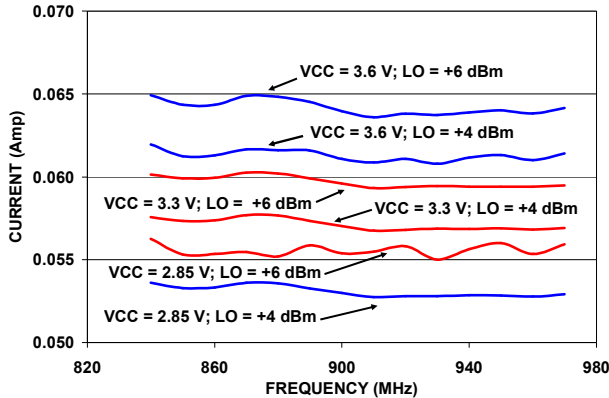

Lead-Free 6 x 6 mm, 28-lead PQFN†

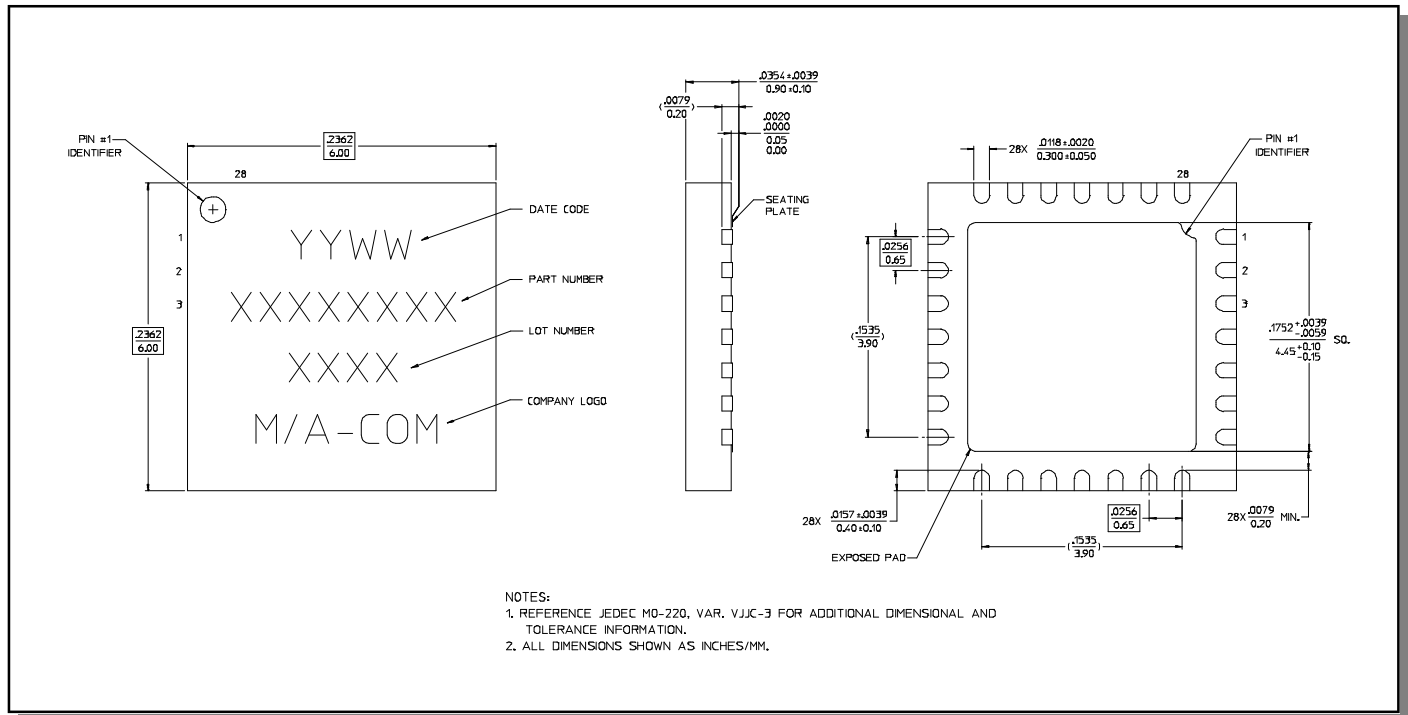

† Reference Application Note M538 for lead-free solder reflow recommendations.