

LZ95G71

Single-chip Driver LSI for CCD

DESCRIPTION

The LZ95G71 is a CMOS single chip driver LSI which provides timing pulses used to drive a CCD area sensor, and generates synchronous pulses for TV signals and processing pulses for video signals.

FEATURES

- Switchable between 410 000 pixels CCD and 470 000 pixels CCD
- Switchable between NTSC (EIA) and PAL (CCIR) systems
- Built-in EE (Electronic Exposure) control (1/60 to 1/100 000 s for NTSC; 1/50 to 1/100 000 s for PAL)

- Internal electronic shutter :
Shutter speed is selectable from 1/60 (PAL : 1/50), 1/250, 1/500, 1/1 000, 1/2 000, 1/4 000 and 1/100 000 s, in addition to this, 1/100 (PAL : 1/120 s) in Flicker-less mode using parallel code
- Switchable between Electronic Shutter mode and EE Control mode
- Single +5 V power supply
- Package : 72-pin QFP(QFP072-P-1010)

PIN CONNECTIONS

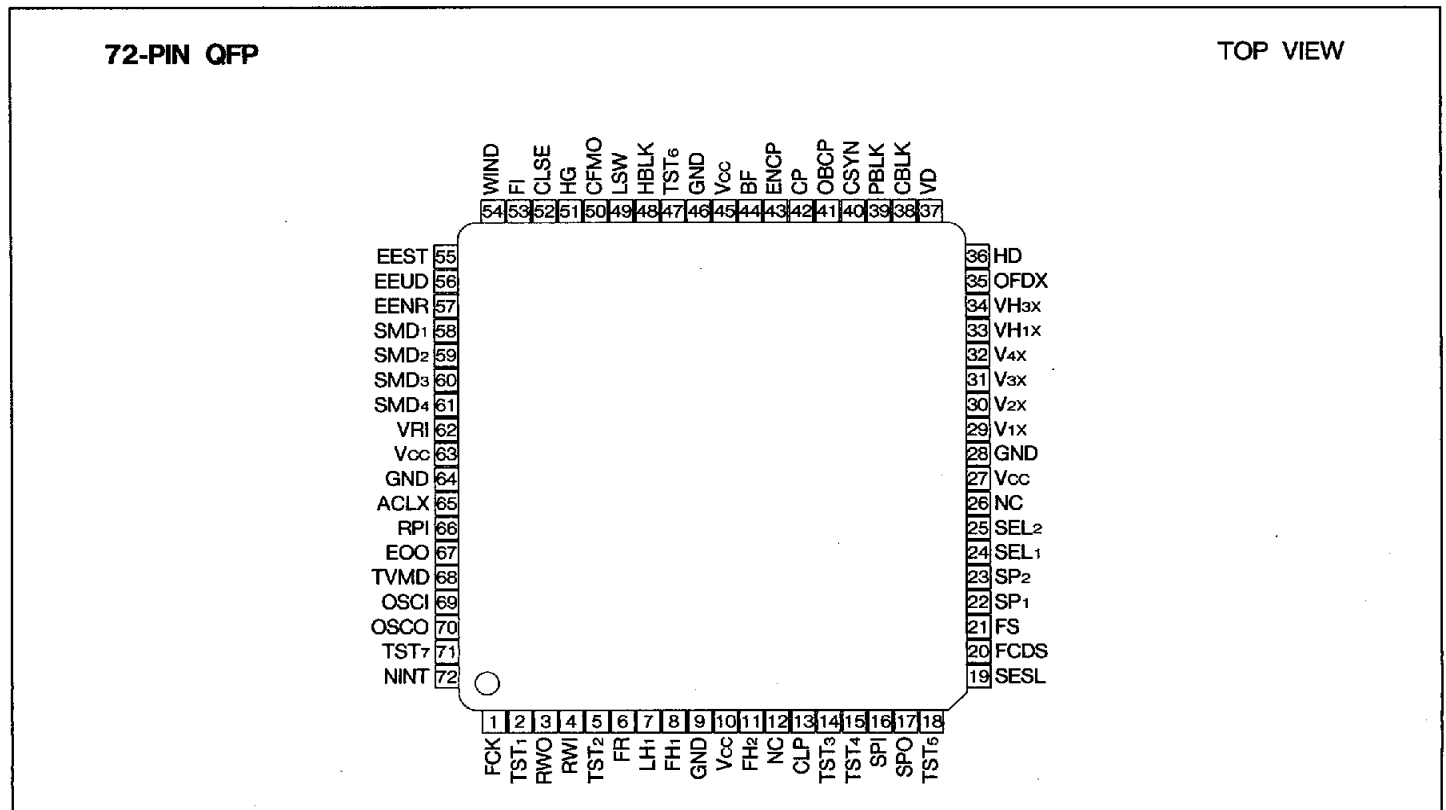

BLOCK DIAGRAM

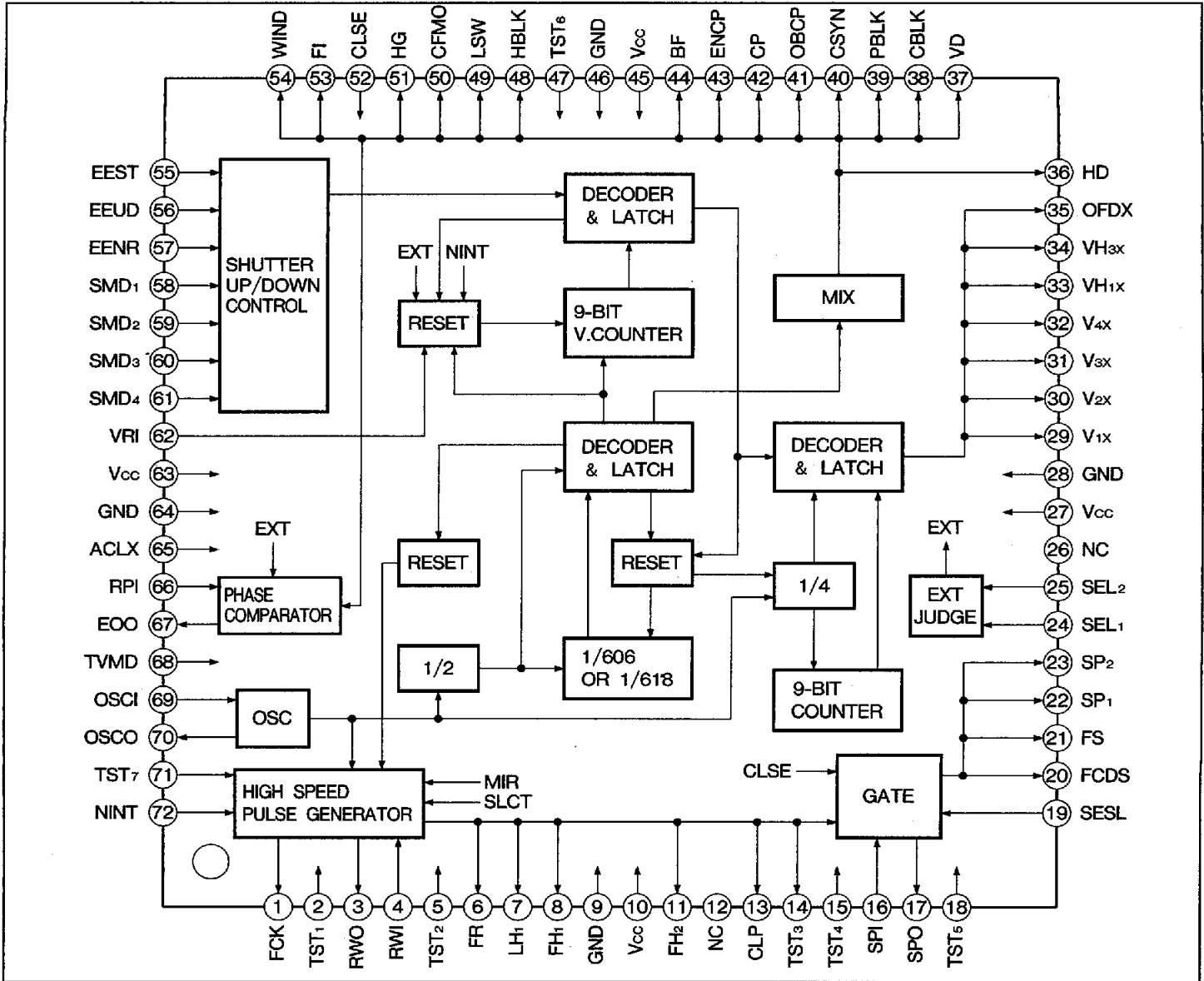

ABSOLUTE MAXIMUM RATINGS

PARAMETER	SYMBOL	RATING	UNIT
Supply voltage	V _{CC}	-0.3 to 7.0	V
Input voltage	V _I	-0.3 to V _{CC} +0.3	V
Output voltage	V _O	-0.3 to V _{CC} +0.3	V
Operating temperature	T _{opr}	-20 to +70	°C
Storage temperature	T _{stg}	-55 to +150	°C

DC CHARACTERISTICS









(V_{CC} = +5 V ± 10%, T_a = -20 to +70°C)

PARAMETER	SYMBOL	CONDITIONS	MIN.	TYP.	MAX.	UNIT	NOTE
Input Low voltage	V _{IL}				1.5	V	1
Input High voltage	V _{IH}		3.5			V	
Input Low voltage	V _{T+}				3.7	V	2
Input High voltage	V _{T-}		1.0			V	
Hysteresis voltage	V _{T+} - V _{T-}		0.4			V	
Input Low current	I _{IL1}	V _I = 0 V			1.0	μA	3
	I _{IL2}	V _I = 0 V	8.0		70	μA	4
Input High current	I _{IH1}	V _I = V _{CC}			1.0	μA	5
	I _{IH2}	V _I = V _{CC}	8.0		70	μA	6
Output High voltage	V _{OH1}	I _{OH} = -2 mA	4.0			V	7
Output Low voltage	V _{OL1}	I _{OL} = 4 mA			0.4	V	
Output High voltage	V _{OH2}	I _{OH} = -3 mA	4.0			V	8
Output Low voltage	V _{OL2}	I _{OL} = 4 mA			0.4	V	
Output High voltage	V _{OH3}	I _{OH} = -6 mA	4.0			V	9
Output Low voltage	V _{OL3}	I _{OL} = 8 mA			0.4	V	
Output High voltage	V _{OH4}	I _{OH} = -9 mA	4.0			V	10
Output Low voltage	V _{OL4}	I _{OL} = 12 mA			0.4	V	
Output High voltage	V _{OH5}	I _{OH} = -9 mA	4.0			V	11
Output Low voltage	V _{OL5}	I _{OL} = 18 mA			0.4	V	
Output High voltage	V _{OH6}	I _{OH} = -6 mA	4.0			V	12
Output Low voltage	V _{OL6}	I _{OL} = 12 mA			0.4	V	
Leak output current	I _{OZ}	High-Z			1.0	μA	















NOTES :



1. Applied to inputs (IC, ICD, ICU).
2. Applied to input (ICSU).
3. Applied to inputs (IC, ICD).
4. Applied to inputs (ICU, ICSU).
5. Applied to inputs (IC, ICU, ICSU).
6. Applied to input (ICD).
7. Applied to outputs (O, OR1, OSC)
(Output (OSC) measures on conditions that input (IBF0) level is 0 V or V_{CC}).
8. Applied to output (ORA).
9. Applied to output (ORB).
10. Applied to output (ORC).
11. Applied to output (ORD).
12. Applied to tri-state output (TO).

PIN FUNCTION

PIN NO.	SYMBOL	I/O	POLARITY	PIN NAME	FUNCTION
1	FCK	O		Clock output for delay line	A pulse for clock of CCD delay line. The frequency of the signal is 1/2 frequency of the OSC1.
2	TST ₁	ICD	—	Test terminal 1	A test pin. Set open or to L level in the Normal mode.
3	RWO	O		Width of FR control output	A pulse to control pulse width of FR (pin 6). Connect to RWI (pin 4) pin through CR delay circuit.
4	RWI	IC	—	Width of FR control input	An input pin to control pulse width of FR. Falling edge of FR is defined by leading edge of input pulse.
5	TST ₂	ICD	—	Test terminal 2	A test pin. Set open or to L level in the Normal mode.
6	FR	O		Reset pulse	A reset pulse for CCD. Connect to ϕ_R of CCD through the DC offset circuit.
7	LH ₁	O		Horizontal transfer last pulse	A pulse to drive the last gate of horizontal CCD. Connect to LH ₁ of CCD.
8	FH ₁	O		Horizontal transfer pulse 1	A horizontal transfer pulse for CCD. Connect to ϕ_{H1} of CCD.
9	GND	—	—	Ground	A grounding pin.
10	Vcc	—	—	Power supply	Supply +5 V power.
11	FH ₂	O		Horizontal transfer pulse 2	A horizontal transfer pulse for CCD. Connect to ϕ_{H2} of CCD.
12	NC	—	—	No-connection	A pin for no use.
13	CLP	O		Clamp pulse	A pulse to clamp dummy output of CCD. The repetition is horizontal frequency.
14	TST ₃	ICD	—	Test terminal 3	A test pin. Set open or to L level in the Normal mode.
15	TST ₄	ICD	—	Test terminal 4	
16	SPI	IC	—	Phase of SP ₁ , SP ₂ control input	An input pin to control pulse phase of SP ₁ , SP ₂ .
17	SPO	O		Phase of SP ₁ , SP ₂ control output	A pulse to control pulse phase of SP ₁ , SP ₂ . Connect to SPI (pin 16) pin through the CR delay circuit.
18	TST ₅	ICD	—	Test terminal 5	A test pin. Set open or to L level in the Normal mode.
19	SESL	ICU	—	SPO control input	An input pin to switch phase of SPO. H level or open : The pulse is delayed by about 35 ns from RWO. L level : The pulse is nearly RWO pulse.

PIN NO.	SYMBOL	I/O	POLARITY	PIN NAME	FUNCTION										
20	FCDS	O		CDS pulse 1	A pulse to clamp the feed-through level from CCD.										
21	FS	O		CDS pulse 2	A pulse to sample-hold the signal from CCD.										
22	SP ₁	O		Color sampling pulse 1	A pulse to output the sampling for color separation based upon the output signal of CCD.										
23	SP ₂	O		Color sampling pulse 2	A pulse to output the sampling for color separation based upon the output signal of CCD.										
24	SEL ₁	ICD	-	External Synchronization mode select 1	Select External Synchronization mode.										
					<table border="1"> <thead> <tr> <th>SEL₁</th> <th>SEL₂</th> <th>Mode description</th> </tr> </thead> <tbody> <tr> <td>L</td> <td>L</td> <td>Internal Synchronization mode</td> </tr> <tr> <td>H</td> <td>L</td> <td>External Synchronization mode 1 : VD (negative polarity) or AC power line RPI input : Internal VD or AC power line</td> </tr> <tr> <td>L</td> <td>H</td> <td>External Synchronization mode 2 : Composite Synchronization mode VRI input : VSYNC (negative polarity) RPI input : CSYNC (negative polarity)</td> </tr> <tr> <td>H</td> <td>H</td> <td>External Synchronization mode 3 : HD and VD synchronization VRI input : external VD (negative polarity) RPI input : external HD (negative polarity)</td> </tr> </tbody> </table>	SEL ₁	SEL ₂	Mode description	L	L	Internal Synchronization mode	H	L	External Synchronization mode 1 : VD (negative polarity) or AC power line RPI input : Internal VD or AC power line	L
SEL ₁	SEL ₂	Mode description													
L	L	Internal Synchronization mode													
H	L	External Synchronization mode 1 : VD (negative polarity) or AC power line RPI input : Internal VD or AC power line													
L	H	External Synchronization mode 2 : Composite Synchronization mode VRI input : VSYNC (negative polarity) RPI input : CSYNC (negative polarity)													
H	H	External Synchronization mode 3 : HD and VD synchronization VRI input : external VD (negative polarity) RPI input : external HD (negative polarity)													
25	SEL ₂	ICD	-	External Synchronization mode select 2											
26	NC	-	-	No-connection	A pin for no use.										
27	V _{CC}	-	-	Power supply	Supply +5V power.										
28	GND	-	-	Ground	A grounding pin.										
29	V _{1X}	O		Vertical transfer pulse 1	A vertical transfer pulse for CCD. Connect to the 1AX pin of vertical driver LSI.										
30	V _{2X}	O		Vertical transfer pulse 2	A vertical transfer pulse for CCD. Connect to the 2AX pin of vertical driver LSI.										
31	V _{3X}	O		Vertical transfer pulse 3	A vertical transfer pulse for CCD. Connect to the 3AX pin of vertical driver LSI.										
32	V _{4X}	O		Vertical transfer pulse 4	A vertical transfer pulse for CCD. Connect to the 4AX pin of vertical driver LSI.										
33	VH _{1X}	O		Read out pulse	A pulse that transfers the charge of the photodiode to the vertical shift register. Connect to the 1BX pin of the vertical driver LSI.										

PIN NO.	SYMBOL	I/O	POLARITY	PIN NAME	FUNCTION
34	VH _{3x}	O		Read out pulse	A pulse that transfers the charge of the photodiode to the vertical shift register. Connect to the 3BX pin of the vertical driver LSI.
35	OFDX	O		OFD pulse output	A pulse that sweeps the charge of the photodiode for electrical shutter. Connect to OFD of CCD through the invert, level shift and DC offset circuit. It is held at H level in Normal mode.
36	HD	O		Horizontal drive pulse	The pulse occurs at the start of lines.
37	VD	O		Vertical drive pulse	The pulse occurs at the start of every field.
38	CBLK	O		Composite blanking pulse	Composite blanking pulse.
39	PBLK	O		Pre-blanking pulse	Equivalent to CBLK (pin 8) pulse except for shorter pulse width with cut-off falling edge.
40	CSYN	O		Composite synchronizing pulse	Composite synchronous signal output pin.
41	OBCP	O		Optical black clamp pulse	A pulse to clamp the optical black signal. This pulse stays Low during the absence of effective pixels within the vertical blanking. The repetition is horizontal frequency.
42	CP	O		Clamp pulse	CP is the same as OBCP (pin 41) except that CP is delayed by 600 ns from OBCP.
43	ENCP	O		Encoder DC clamp pulse	A clamp pulse that is used for recovering DC level. The repetition is horizontal frequency.
44	BF	O		Burst flag	A pulse to define burst period.
45	V _{cc}	—	—	Power supply	Supply +5 V power.
46	GND	—	—	Ground	A grounding pin.
47	TST ₆	ICD	—	Test terminal 6	A test pin. Set open or to L level in the Normal mode.
48	HBLK	O		Horizontal blanking pulse	A pulse that corresponds to the cease period of the horizontal transfer pulse.
49	LSW	O		Line switch	The signal switches between H and L at every line in PAL mode. It is set at Low level at the 1st line of the 1st field.
50	CFMO	O		Color frame output	A pulse to control color frame. Occurs at every 4 fields in NTSC mode, occurs at every 8 fields in PAL mode.

PIN NO.	SYMBOL	I/O	POLARITY	PIN NAME	FUNCTION												
51	HG	O		Line index pulse	The pulse is used in color separator. The signal switches between H and L at every line. For details, see "NOTES 1".												
52	CLSE	ICD	-	Color sampling pulse control input	<p>An input pin to control SP₁, SP₂ pulse correspond to color separator in signal processor.</p> <table border="1"> <tr> <td>CLSE input</td> <td>Output to sample hold at color separator.</td> </tr> <tr> <td>L level or open</td> <td>SP₁ : Output contain Ye signal. SP₂ : Output contain Cy signal.</td> </tr> <tr> <td>HG pulse</td> <td>SP₁ : Output contain Mg signal. SP₂ : Output contain G signal.</td> </tr> </table>	CLSE input	Output to sample hold at color separator.	L level or open	SP ₁ : Output contain Ye signal. SP ₂ : Output contain Cy signal.	HG pulse	SP ₁ : Output contain Mg signal. SP ₂ : Output contain G signal.						
CLSE input	Output to sample hold at color separator.																
L level or open	SP ₁ : Output contain Ye signal. SP ₂ : Output contain Cy signal.																
HG pulse	SP ₁ : Output contain Mg signal. SP ₂ : Output contain G signal.																
53	FI	O		Field index	<p>The pulse is used for detecting field.</p> <p>At NTSC mode : ODD field; Low EVEN field; High</p> <p>At PAL mode : 1st and 3rd fields; Low 2nd and 4th fields; High</p>												
54	WIND	O		Wind pulse	A pulse for wind pulse. When connected to EEST (pin 55), the operation of Electronic Exposure can be stopped at the upper side of monitor.												
55	EEST	ICU	-	Electronic Exposure control 1	<p>An input pin to control Electronic Exposure, with using EEUD (pin 56) and EENR (pin 57).</p> <p>L level : Electronic Exposure is stopped. H level or open : Electronic Exposure is operated.</p>												
56	EEUD	IC	-	Electronic Exposure control 2	An input pin to control Electronic Exposure, with using EENR (pin 57).												
57	EENR	IC	-	Electronic Exposure control 3	An input pin to control Electronic Exposure, with using EEUD (pin 56). For details, see "NOTE 3".												
58	SMD ₁	ICU	-	Shutter control 1	Input pins to set up fixed shutter speed or to control Electronic Exposure mode. For details, see "NOTE 2".												
59	SMD ₂	ICU	-	Shutter control 2													
60	SMD ₃	ICU	-	Shutter control 3													
61	SMD ₄	ICU	-	Shutter control 4													
62	VRI	ICU	-	Vertical reset input	<p>An input pin for resetting internal Vertical counter. For inputs of SEL₁ (pin 24) and SEL₂ (pin 25), input pulse and the point of resetting is changed.</p> <table border="1"> <thead> <tr> <th>SEL₁</th> <th>SEL₂</th> <th>VRI input</th> </tr> </thead> <tbody> <tr> <td>X</td> <td>L</td> <td>-</td> </tr> <tr> <td>L</td> <td>H</td> <td>External VSYNC (negative)</td> </tr> <tr> <td>H</td> <td>H</td> <td>External VD (negative)</td> </tr> </tbody> </table> <p>X=H or L</p>	SEL ₁	SEL ₂	VRI input	X	L	-	L	H	External VSYNC (negative)	H	H	External VD (negative)
SEL ₁	SEL ₂	VRI input															
X	L	-															
L	H	External VSYNC (negative)															
H	H	External VD (negative)															

PIN NO.	SYMBOL	I/O	POLARITY	PIN NAME	FUNCTION															
63	Vcc	—	—	Power supply	Supply +5 V power.															
64	GND	—	—	Ground	A grounding pin.															
65	ACLX	ICU	—	All clear input	An input pin for resetting all internal circuit at power on.															
66	RPI	ICU	—	Horizontal comparison input	An input pin for the reference signal to the phase comparator, at external synchronization mode. For inputs SEL ₁ (pin 24) and SEL ₂ (pin 25), input pulse is changed. <table border="1" style="margin-left: 20px;"> <thead> <tr> <th>SEL₁</th> <th>SEL₂</th> <th>RPI input</th> </tr> </thead> <tbody> <tr> <td>L</td> <td>L</td> <td>—</td> </tr> <tr> <td>H</td> <td>L</td> <td>External VD (negative) or line</td> </tr> <tr> <td>L</td> <td>H</td> <td>External CSYNC (negative)</td> </tr> <tr> <td>H</td> <td>H</td> <td>External HD (negative)</td> </tr> </tbody> </table>	SEL ₁	SEL ₂	RPI input	L	L	—	H	L	External VD (negative) or line	L	H	External CSYNC (negative)	H	H	External HD (negative)
SEL ₁	SEL ₂	RPI input																		
L	L	—																		
H	L	External VD (negative) or line																		
L	H	External CSYNC (negative)																		
H	H	External HD (negative)																		
67	EOO	TO	—	Phase comparator output	At external synchronization mode, phase comparator output for input signal RPI (pin 66) and internal comparison signal. When RPI is advanced, output is High level. When RPI is delayed, output is Low level. When phases are equal, the terminal impedance is High.															
68	TVMD	ICU	—	TV mode select	An input pin to select TV standards. L level : NTSC, EIA mode H level or open : PAL, CCIR mode															
69	OSCI	IBF0	—	Clock input	An input pin for reference clock oscillation. The frequencies are as follows : At NTSC mode : 28.636 36 MHz (1820 fH) At PAL mode : 28.375 00 MHz (1816 fH) (fH=Horizontal frequency)															
70	OSCO	OSC	—	Clock output	An output pin for reference clock oscillation. The output is the inverse OSCI (pin 69).															
71	TST ₇	ICD	—	Test terminal 7	A test pin. Set open or to L level in the Normal mode.															
72	NINT	ICD	—	Non-interlace select	An input pin to select Non-interlace mode. L level or open : Interlace mode H level : Non-interlace mode															

IC : Input pin (CMOS level).
 ICU : Input pin (CMOS level with pull-up resistor).
 ICSU : Input pin (CMOS schmitt-trigger level with pull-up resistor).
 ICD : Input pin (CMOS level with pull-down resistor).
 O, OR1, ORA : Output pin.
 ORB, ORC, ORD : Output pin.
 TO : Output pin (tri-state output).
 IBF0 : Input pin for oscillation.
 OSC : Output pin for oscillation.

NOTES :

1. Timing of HG (Line index pulse)

TVMD (68Pin)	L (NTSC)	H (PAL)
Reset Line	271 H	318 H
Reset level	L	L

2. Fixed Shutter mode

SMD₁ (Pin 58)=Low level

SMD ₂ (Pin 59)	SMD ₃ (Pin 60)	SMD ₄ (Pin 61)	SHUTTER SPEED (s)	
			NTSC	PAL
L	L	L	About 1/60	About 1/50
H	L	L	About 1/100	About 1/120
L	H	L	About 1/250	
H	H	L	About 1/500	
L	L	H	About 1/1 000	
H	L	H	About 1/2 000	
L	H	H	About 1/5 000	
H	H	H	About 1/12 000	

3. EE Control mode

SMD₁ (Pin 58)=High level

EEUD	EENR	
H	L	Shutter speed up -----
	H	Control stopped -----
L	H	Shutter speed down

- When EENR and EEUD are H level, control is stopped.
- When either EENR or EEUD is L level, control is resumed.
- When EEST set to L level, EE control is disable.

SMD ₂ (Pin 59)	SMD ₃ (Pin 60)	SMD ₄ (Pin 61)	Shutter speed (s)
H	X	X	Maximum shutter speed : 1/100 000
L	X	X	Maximum shutter speed : 1/39 000
X	H	X	Start shutter speed : 1/100 000
X	L	X	Start shutter speed : 1/2 000

X=H or L

www.DataSheet4U.com

Shutter speed changes at Electronic Exposure Control mode.

NTSC			PAL		
NO.	CHARGE TIME	SHUTTER SPEED (s)	NO.	CHARGE TIME	SHUTTER SPEED (s)
1	252 H + α	1/62	1	302 H + β	1/52
.	(by 10 H step)		.	(by 10 H step)	
19	72 H + α	1/218	24	72 H + β	1/216
.	(by 4 H step)		.	(by 4 H step)	
30	28 H + α	1/557	35	28 H + β	1/552
.	(by 2 H step)		.	(by 2 H step)	
37	14 H + α	1/1 102	42	14 H + β	1/1 095
.	(by 1 H step)		.	(by 1 H step)	
43	7 H + α	1/2 163	48	7 H + β	1/2 148
.	(by 0.5 H step)		.	(by 0.5 H step)	
50	4 H + α	1/3 68	55	4 H + β	1/3 655
.	(by 0.25 H step)		.	(by 0.25 H step)	
62	1 H + α	1/12 344	67	1 H + β	1/12 252
.	(by 0.125 H step)		.	(by 0.125 H step)	
70	0.280 H	1/57 274	75	0.275 H	1/56 750
71	0.155 H	1/105 281	76	0.152 H	1/104 320

 $\alpha = 0.275 \text{ H}$ $\beta = 0.275 \text{ H}$

4. VRI input timing

- (1) Internal Synchronization mode (SEL₁=SEL₂=L)
This mode is not used for external synchronization. But if it is connected to negative polarity pulse at VRI pin, this mode is the same as External Synchronization 2.
- (2) External Synchronization mode 1 (SEL₁=H, SEL₂=L)
VRI pin can't be used.
- (3) External Synchronization mode 2 (SEL₁=L, SEL₂=H)
When this mode is selected, the reset-pulse (equal to

VSYNC pulse : polarity is negative) which is used for internal vertical counter continuously input VRI pin from other systems.

※ About pulse timing at synchronization, please see under the figure.
(In the figure, the symbol "Internal pulse" show 2 times horizontal frequency.)

NTSC : (ODD FIELD)

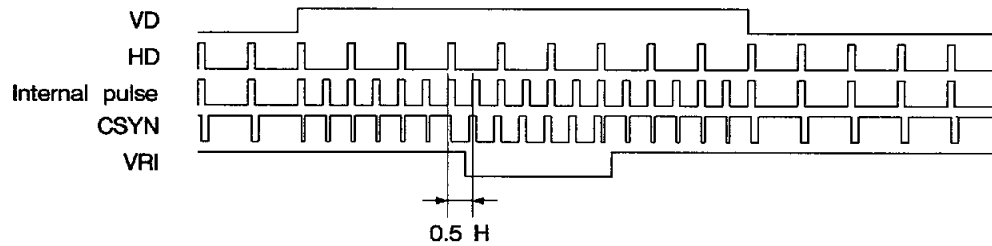

(EVEN FIELD)

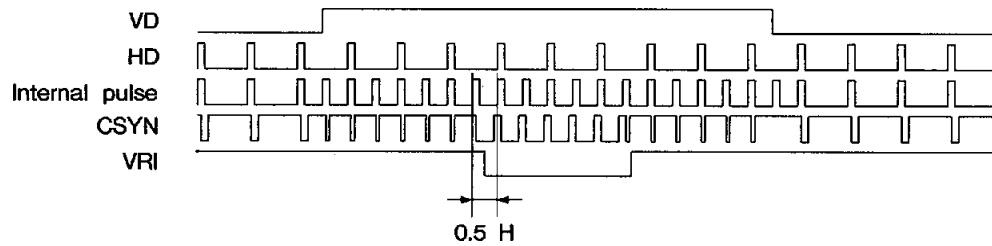

PAL : (1st, 3rd FIELD)

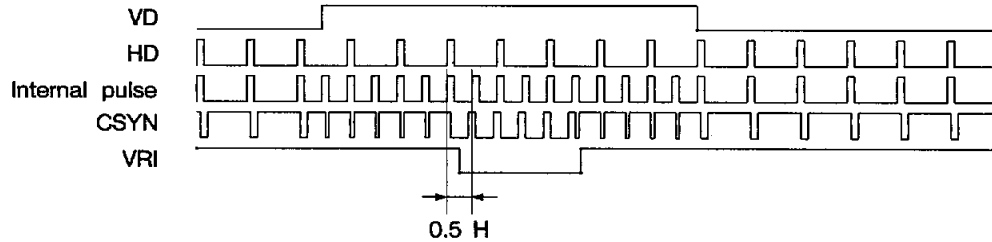

(2nd, 4th FIELD)

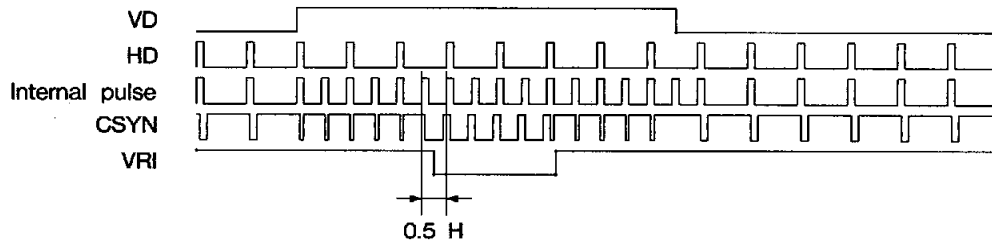

(4) External Synchronization mode 3 (SEL₁=H, SEL₂=H)

When this mode is selected, the reset-pulse (equal to VD pulse : polarity is negative) which is used for internal vertical counter continuously input VRI pin from other systems.

※ About pulse timing at synchronization, please see under the figure. (In the figure, the symbol "Internal pulse" show 2 times horizontal frequency.)

NTSC : (ODD FIELD)

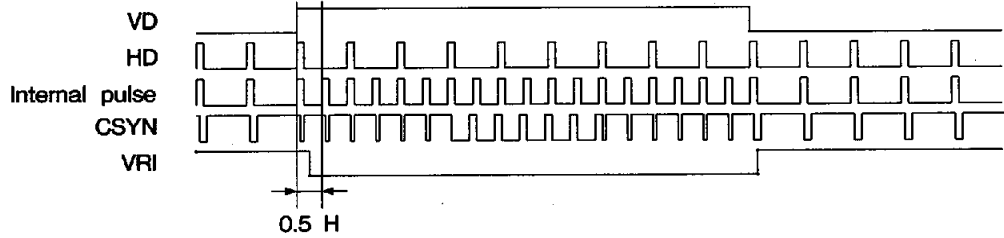

(EVEN FIELD)

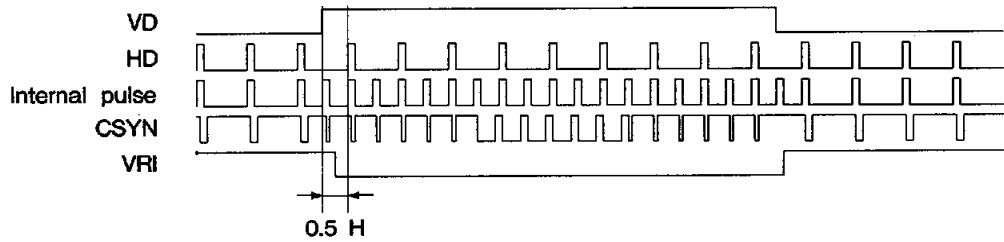

PAL : (1st, 3rd FIELD)

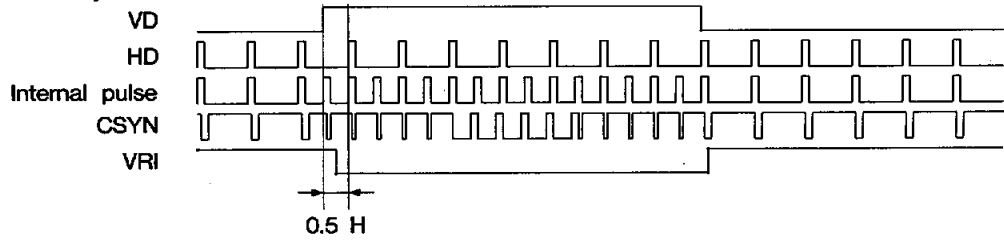

(2nd, 4th FIELD)

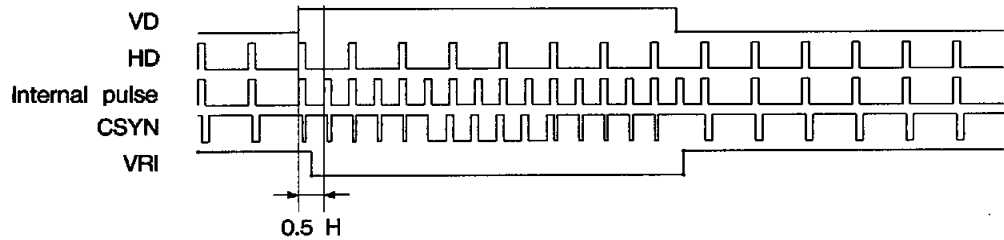

TIMING DIAGRAM SYNCHRONIZING VERTICAL PULSE < NTSC >

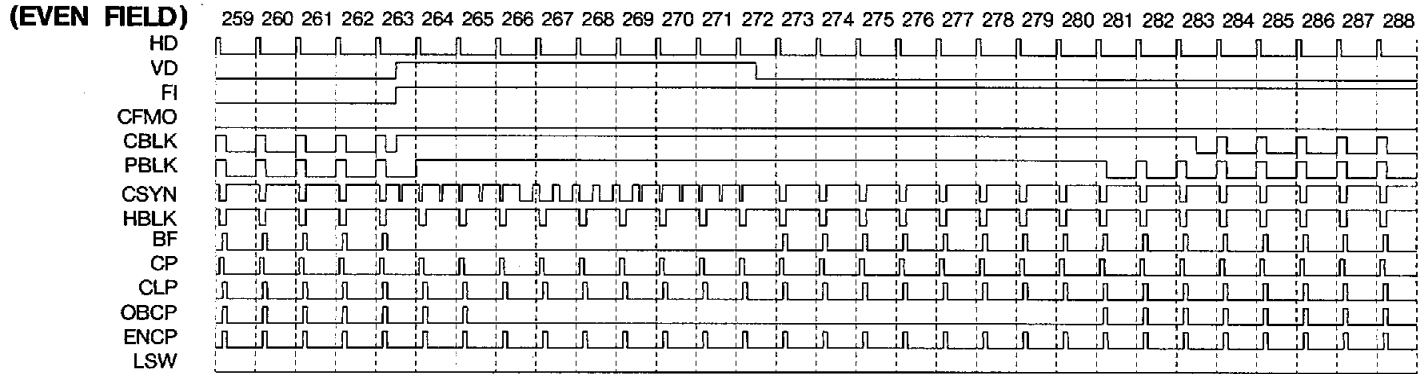
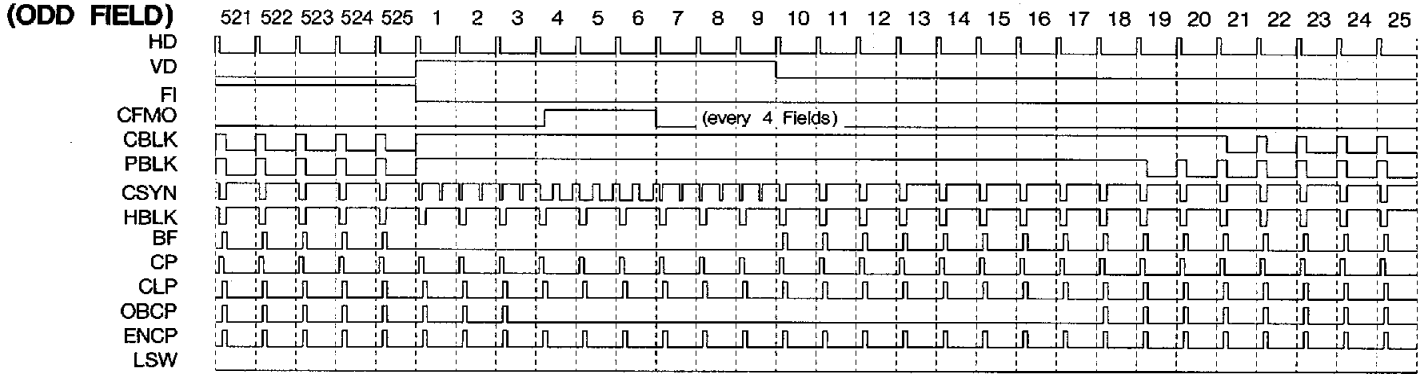

SYNCHRONIZING VERTICAL PULSE < PAL >

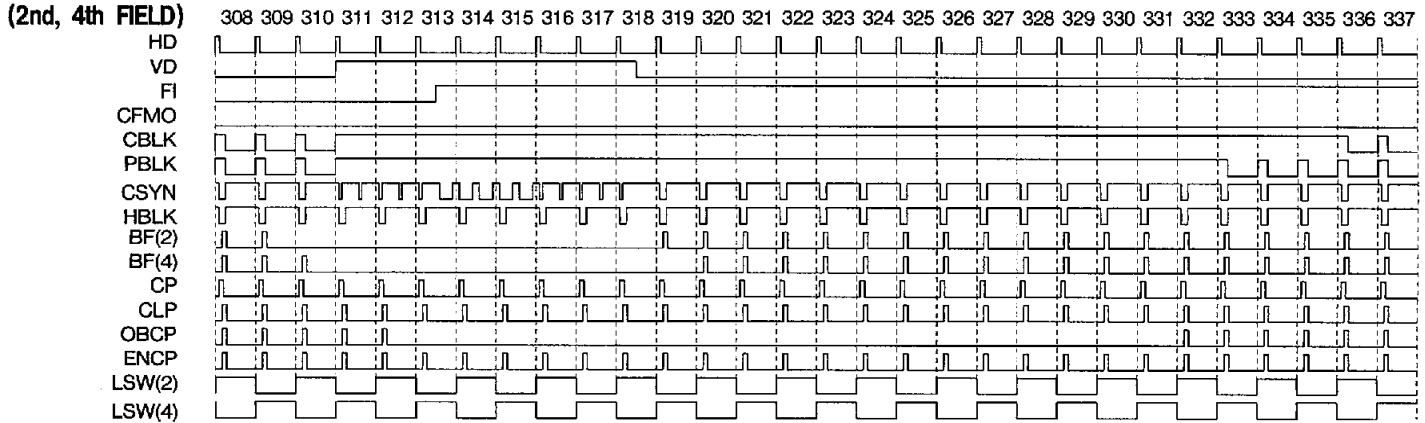
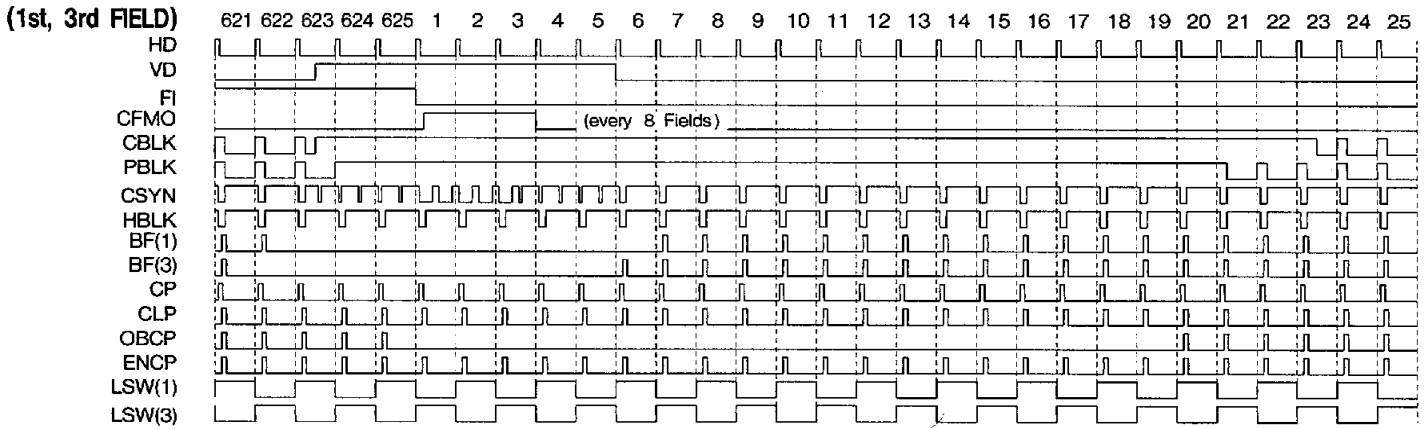

SYNCHRONIZING VERTICAL PULSE

NTSC : (ODD FIELD)

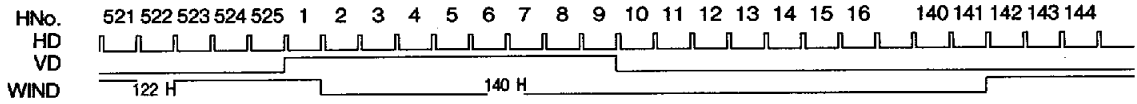

(EVEN FIELD)

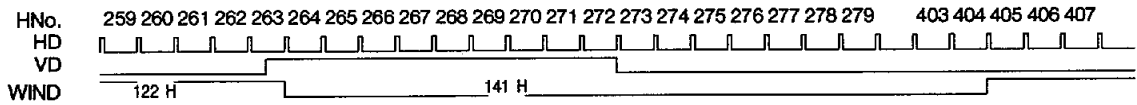

PAL : (1st, 3rd FIELD)

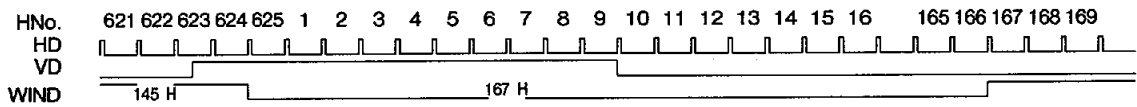

(2nd, 4th FIELD)

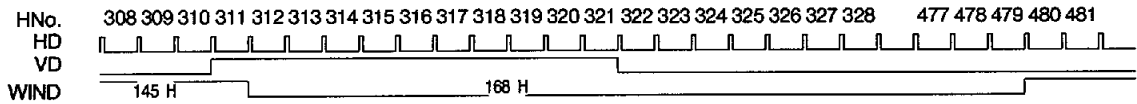

VERTICAL PULSE FOR DRIVING CCD < NTSC >

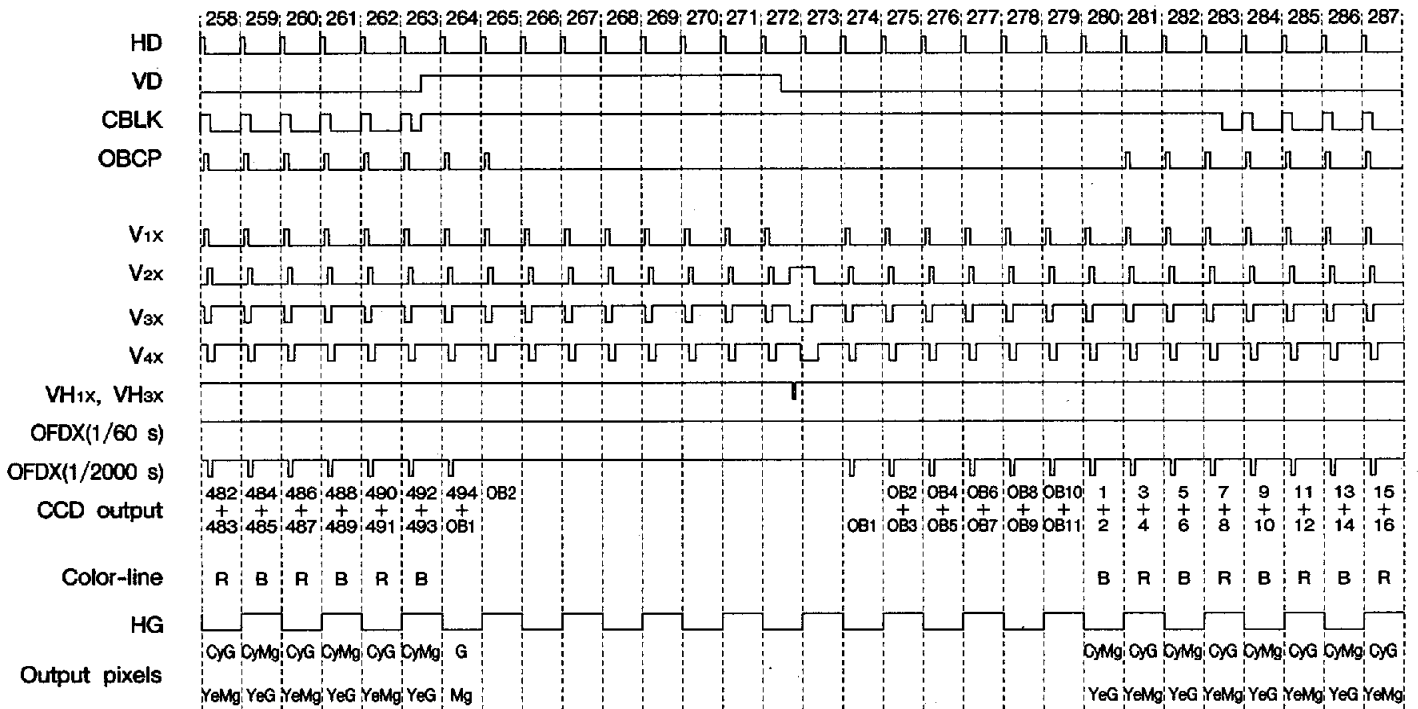
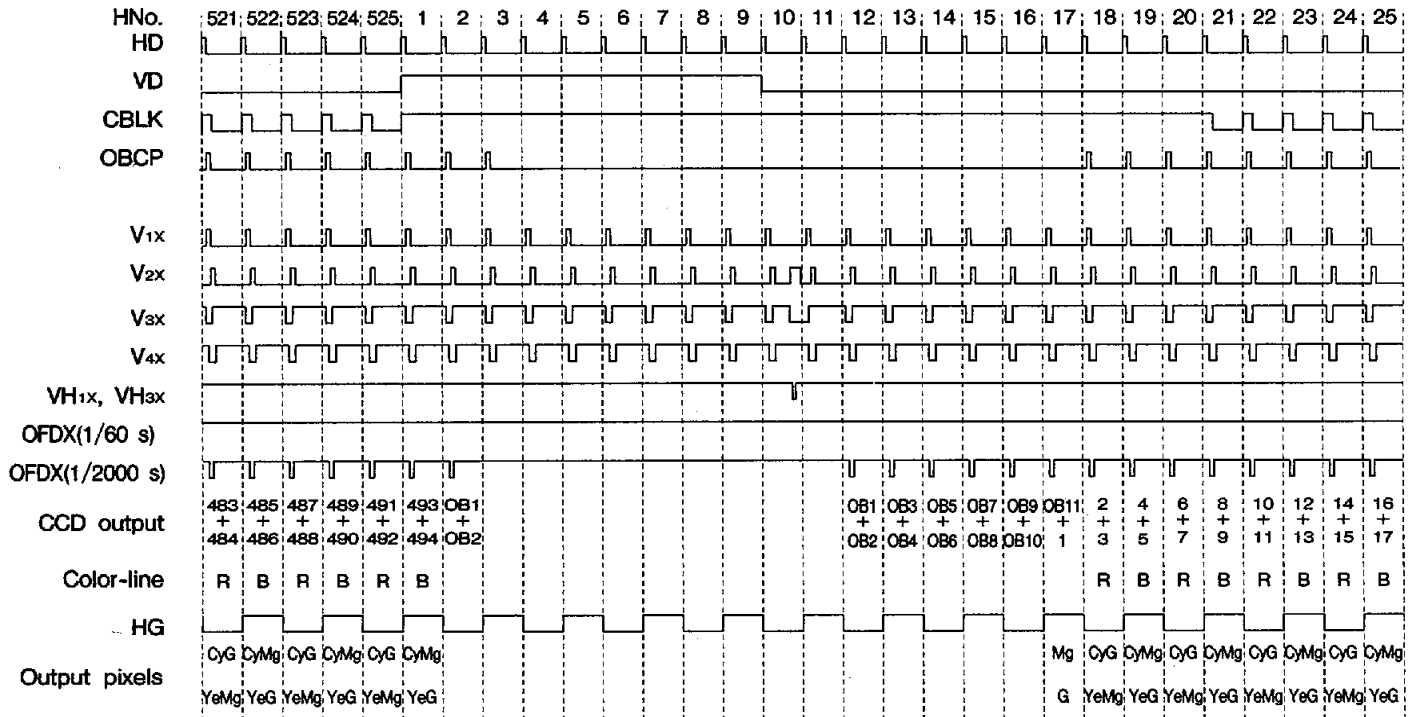

CCD PERIPHERALS



VERTICAL PULSE FOR DRIVING CCD < PAL >

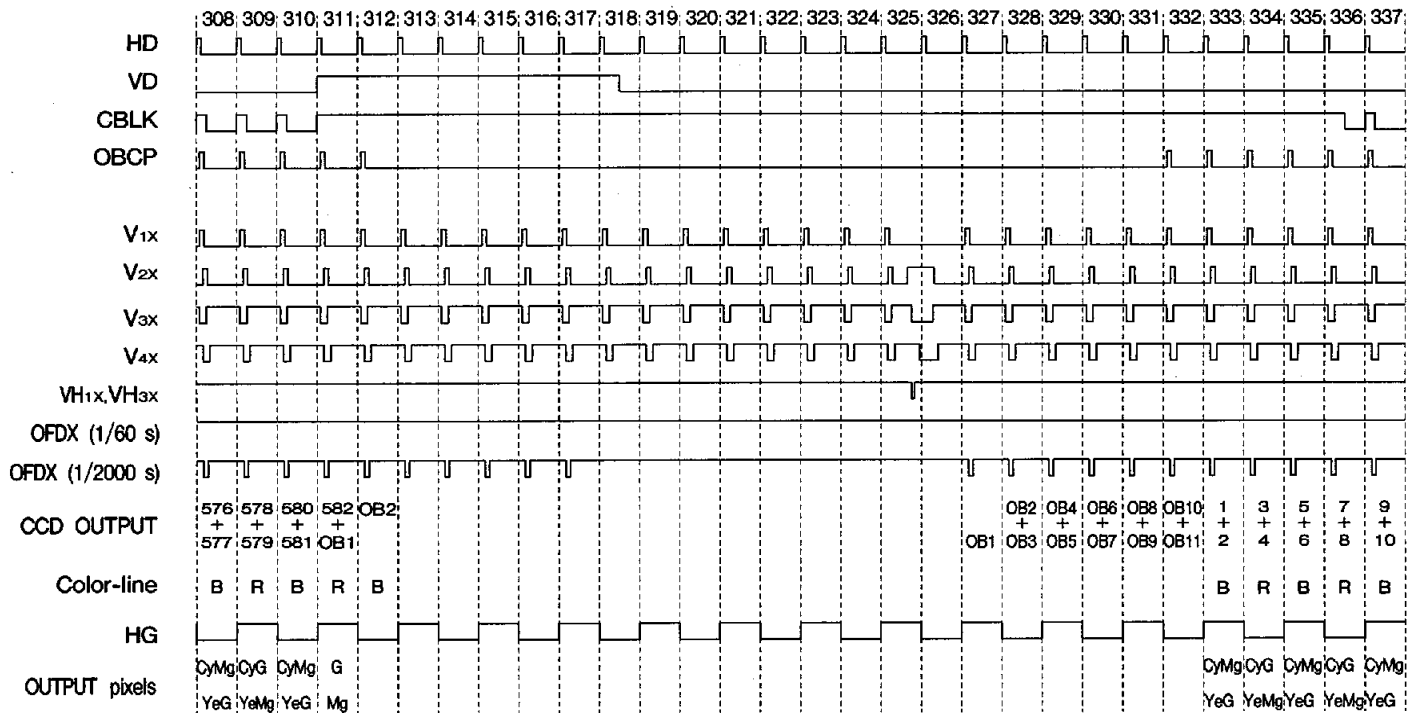
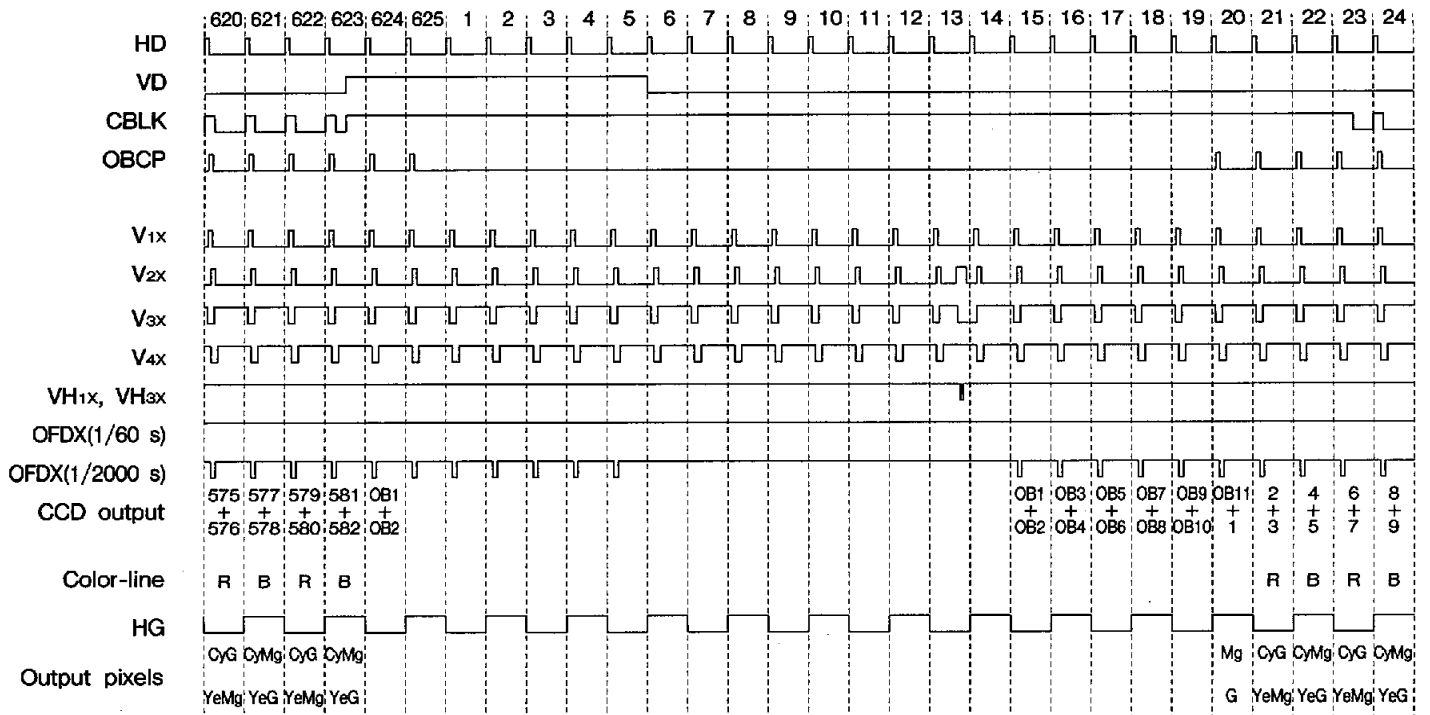

SYNCHRONIZING HORIZONTAL PULSE < NTSC >

Unit : μ s

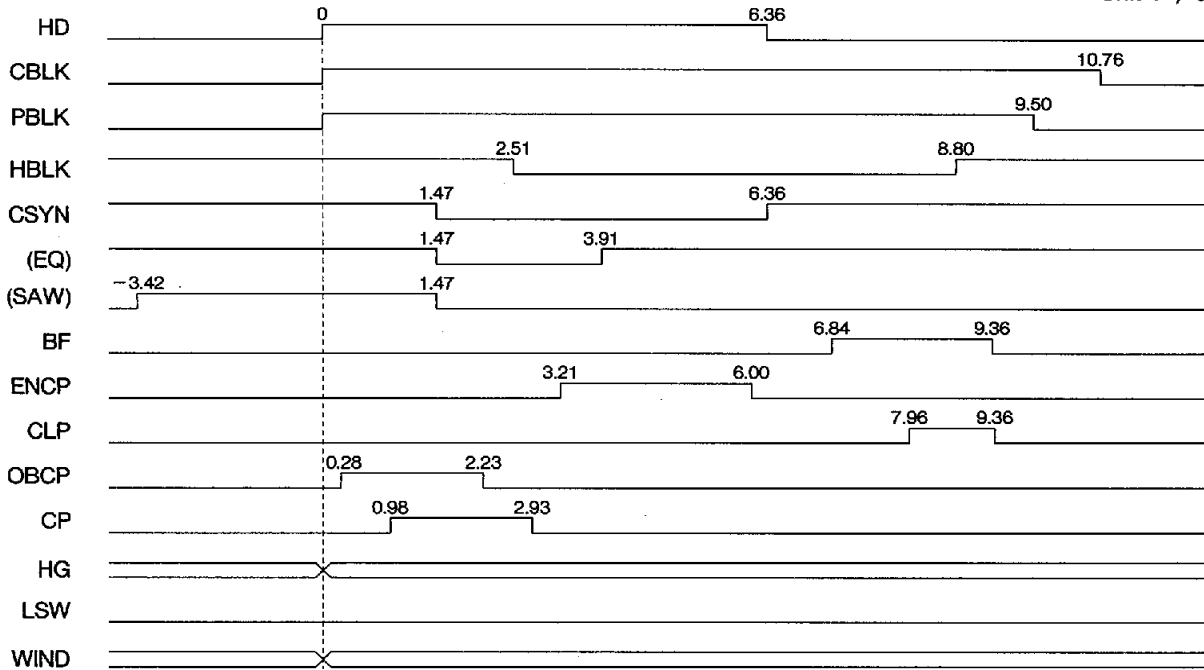

SYNCHRONIZING HORIZONTAL PULSE < PAL >

Unit : μ s

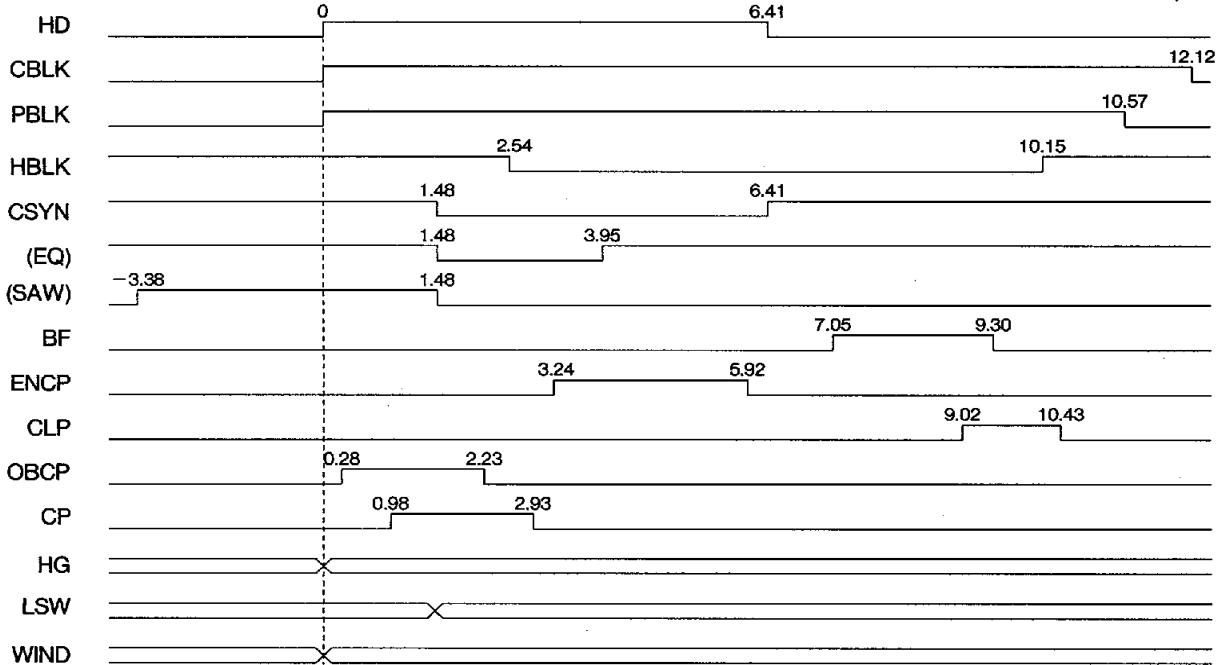

HORIZONTAL PULSE FOR DRIVING CCD < NTSC >

1 clock = 34.9 ns

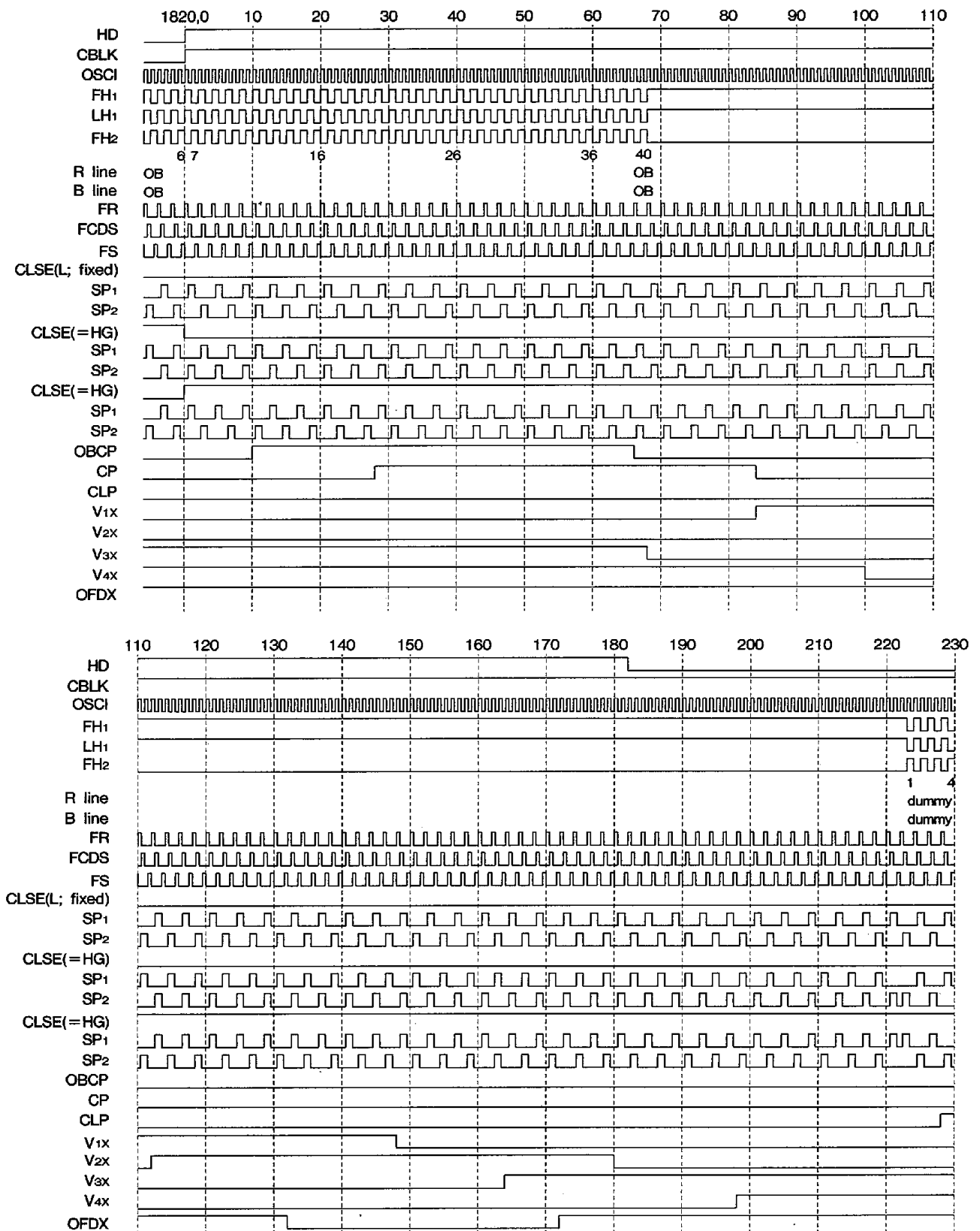

At SESL=L : When SESL=H, SP1 and SP2 is delayed about 35 ns.

HORIZONTAL PULSE FOR DRIVING CCD < NTSC > (con't)

1 clock = 34.9 ns

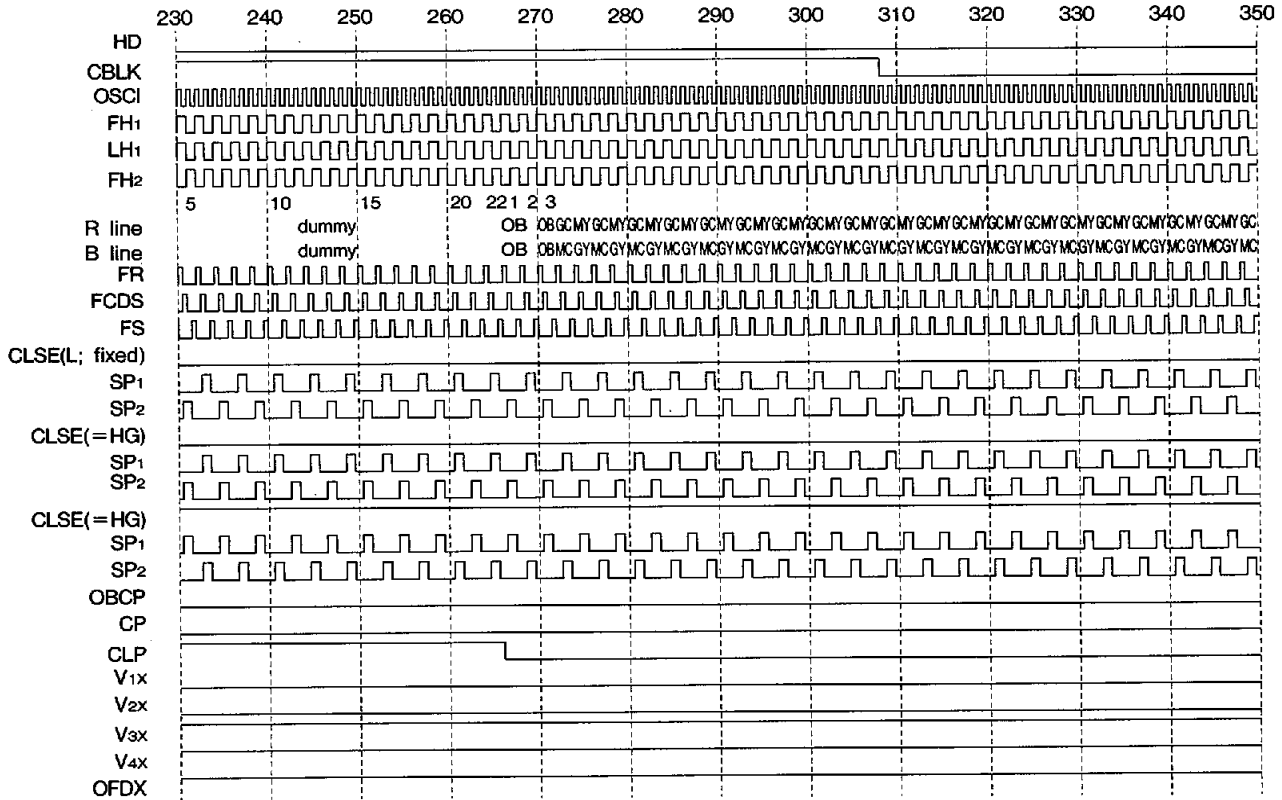

At SESL=L : When SESL=H, SP₁ and SP₂ is delayed about 35 ns.

HORIZONTAL PULSE FOR DRIVING CCD < PAL >

1 clock = 35.2 ns

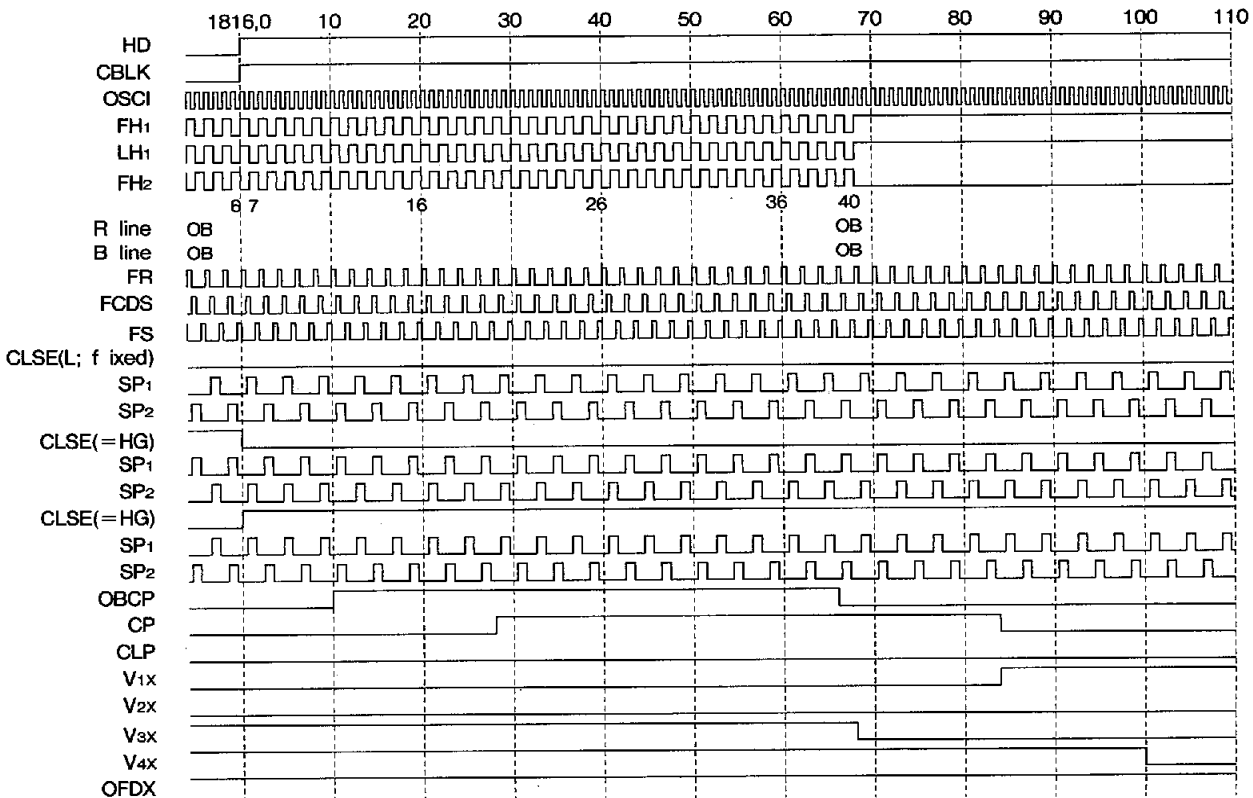

At SESL=L : When SESL=H, SP₁ and SP₂ is delayed about 35 ns.



HORIZONTAL PULSE FOR DRIVING CCD < PAL > (cont'd)

1 clock = 35.2 ns

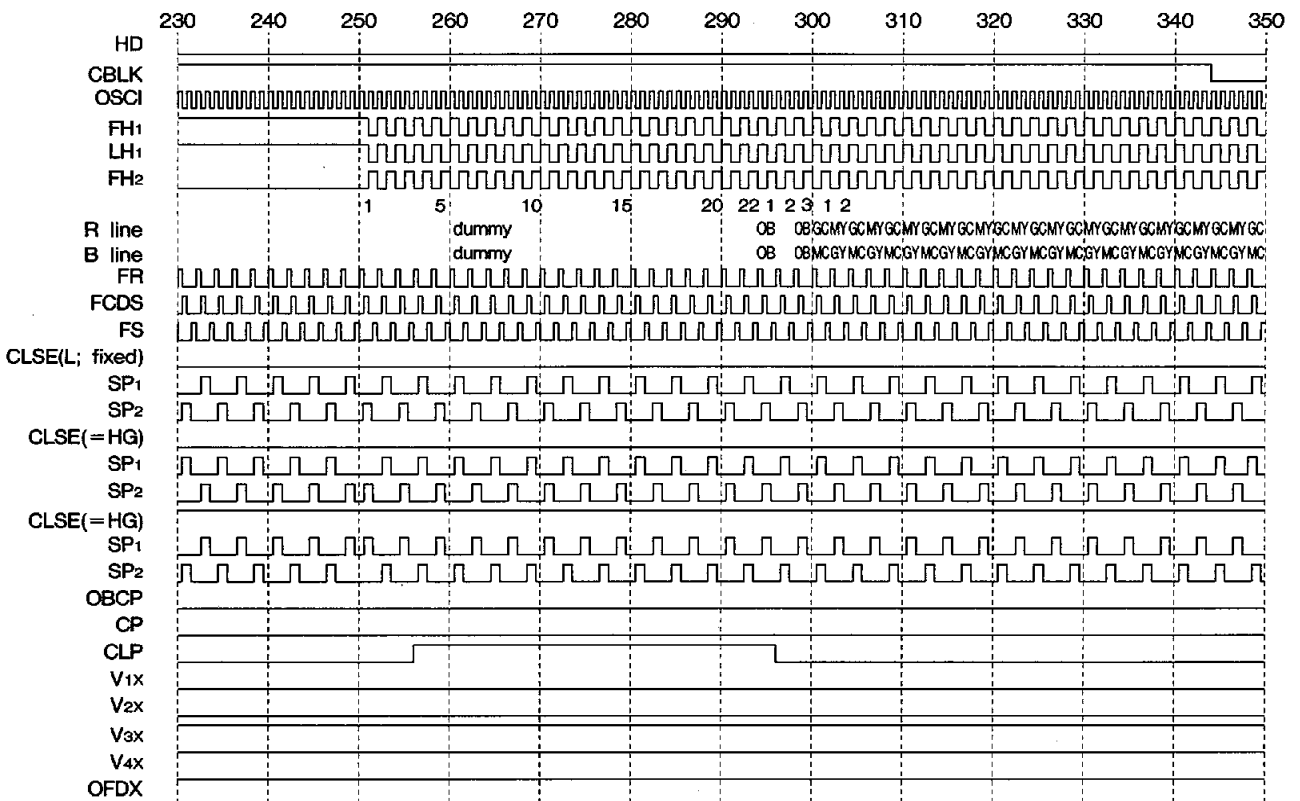
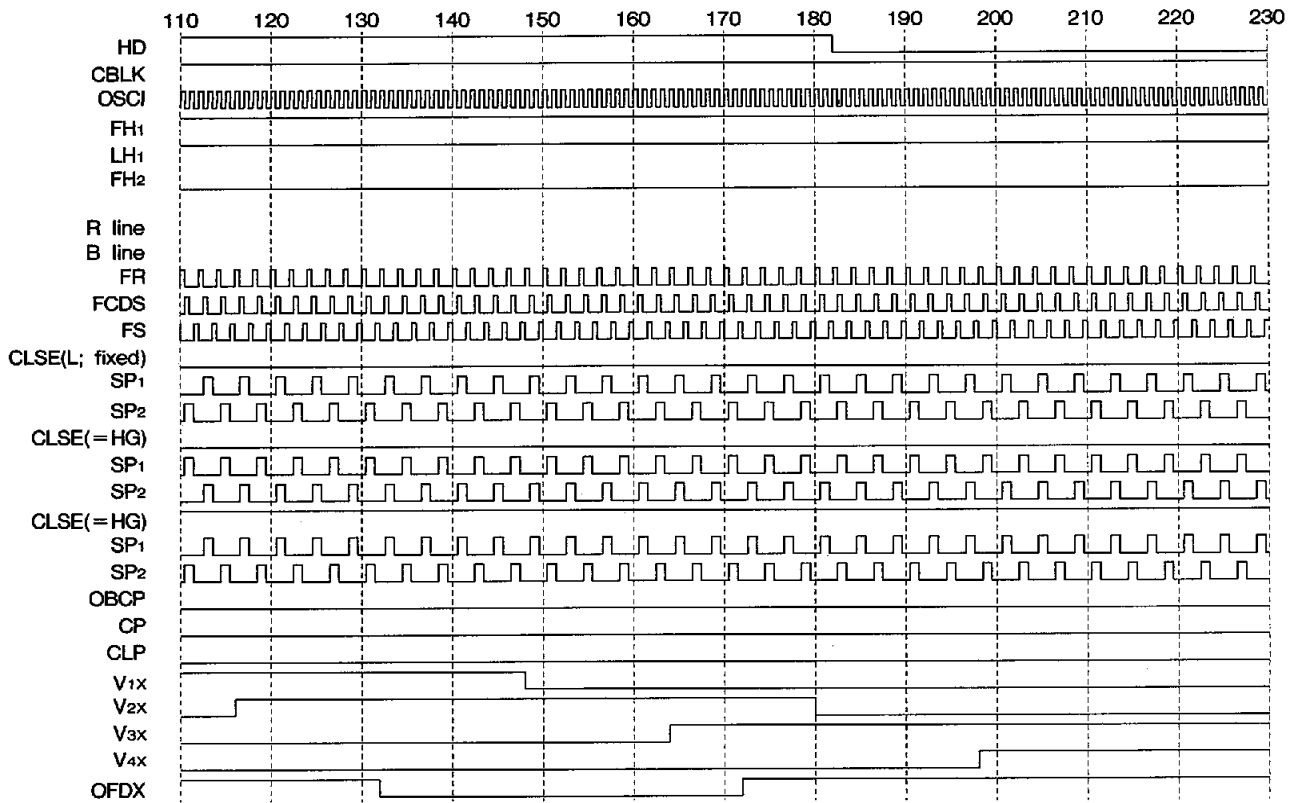

At SESL=L : When SESL=H, SP₁ and SP₂ is delayed about 35 ns.

READ OUT PULSE

The number : OSCI clock pulse,
1 clock = 34.92 ns (35.24 ns), () : PAL

(ODD (1st, 3rd) FIELD)

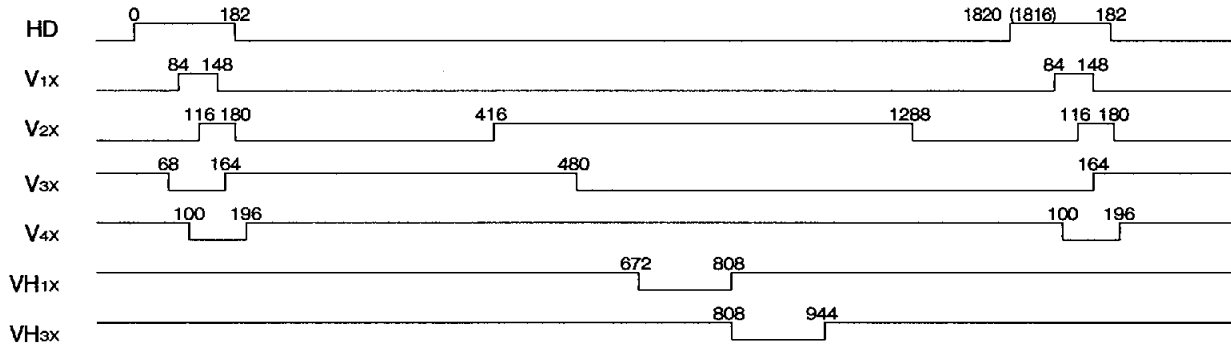

(EVEN (2nd, 4th) FIELD)

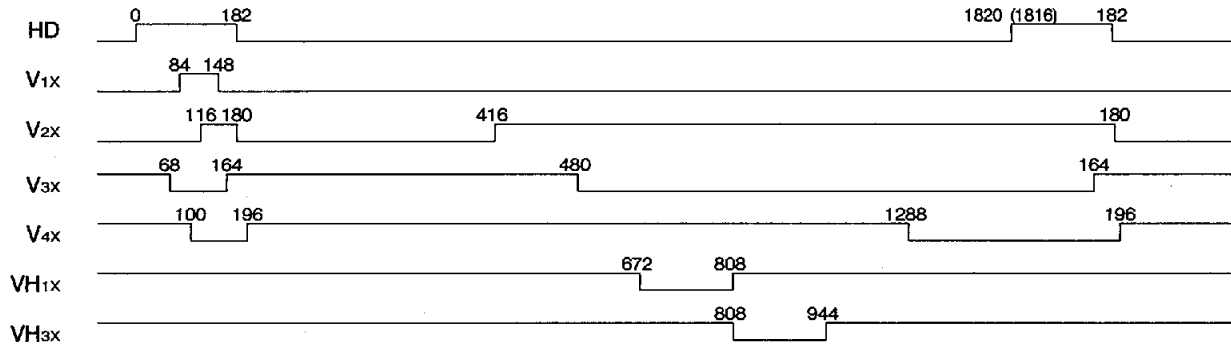

SHUTTER PULSE

The number : OSCI clock pulse,
1 clock = 34.92 ns (35.24 ns), () : PAL

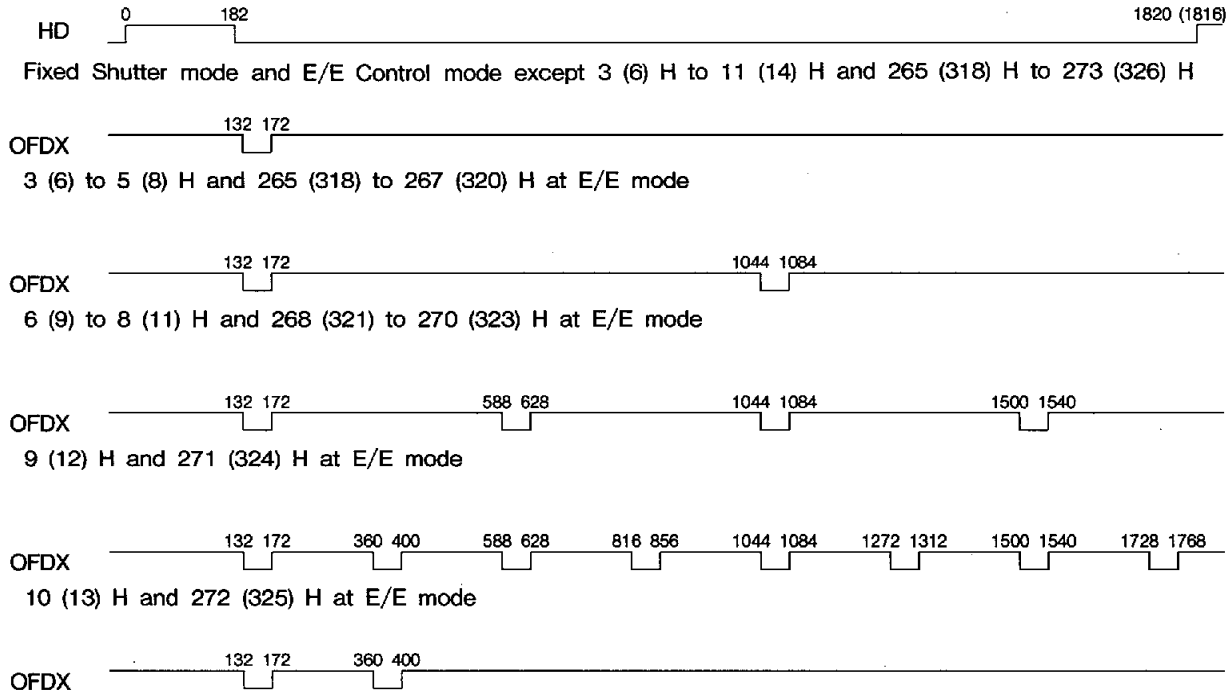

COLOR SEPARATE PULSE

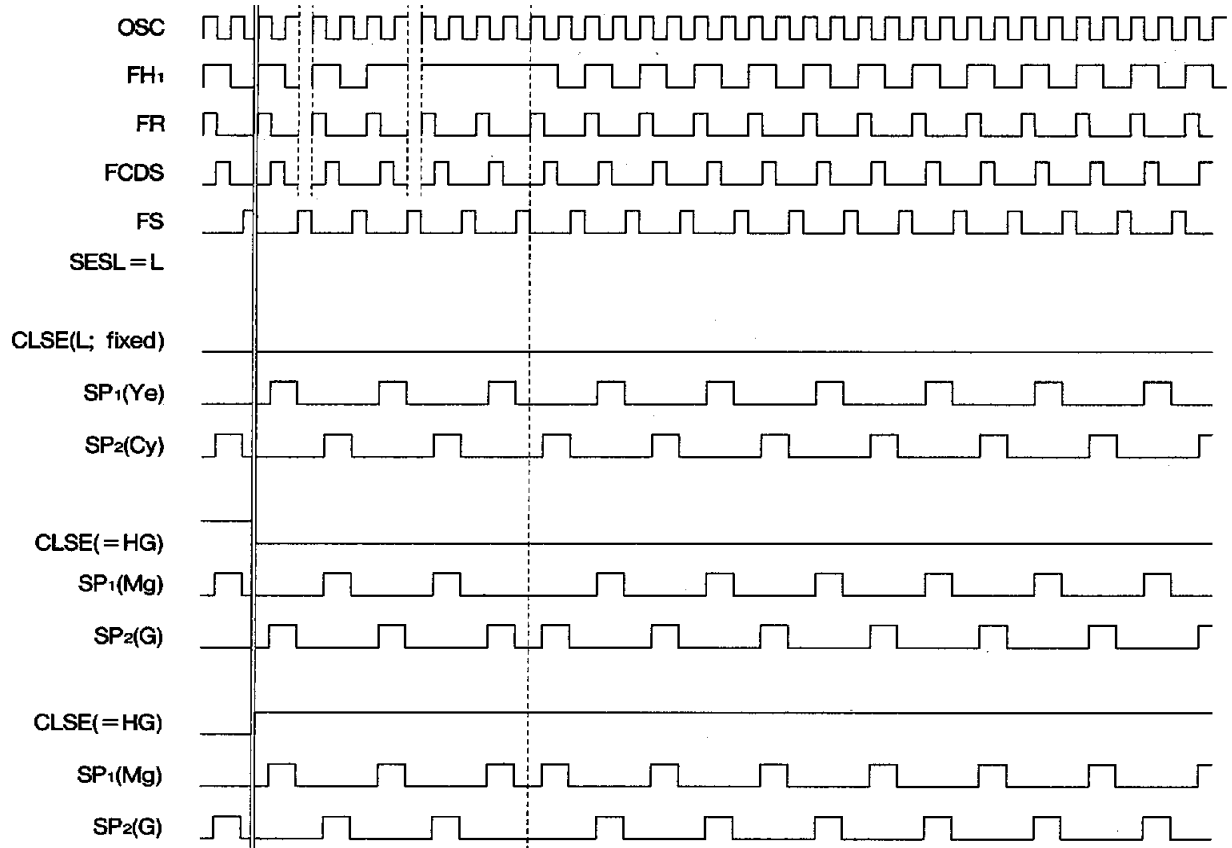

The SP2 pulse is delayed about 35 ns at SESL=H

NON-INTERLACE MODE
 SYNCHRONIZING VERTICAL PULSE < NTSC >

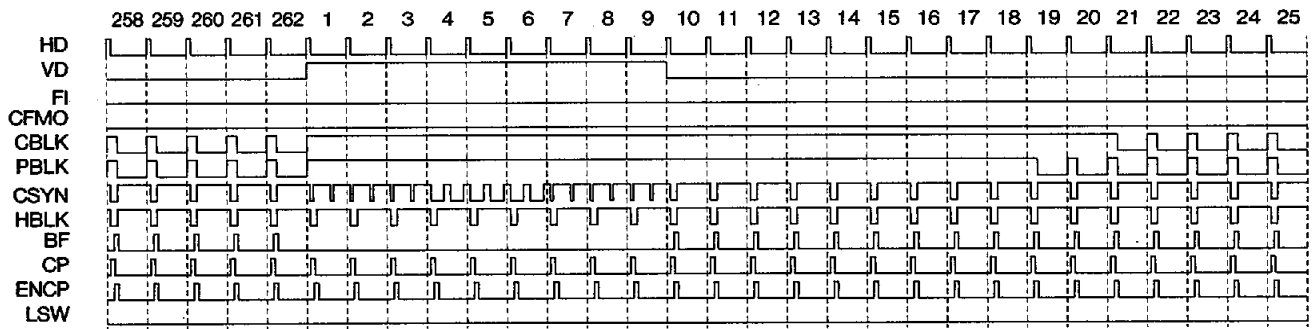

SYNCHRONIZING VERTICAL PULSE < PAL >

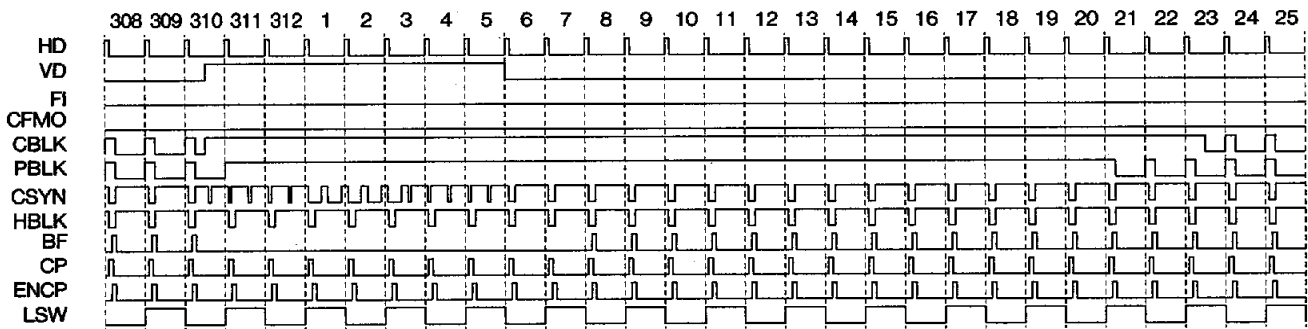

VERTICAL PULSE FOR DRIVING CCD < NTSC >

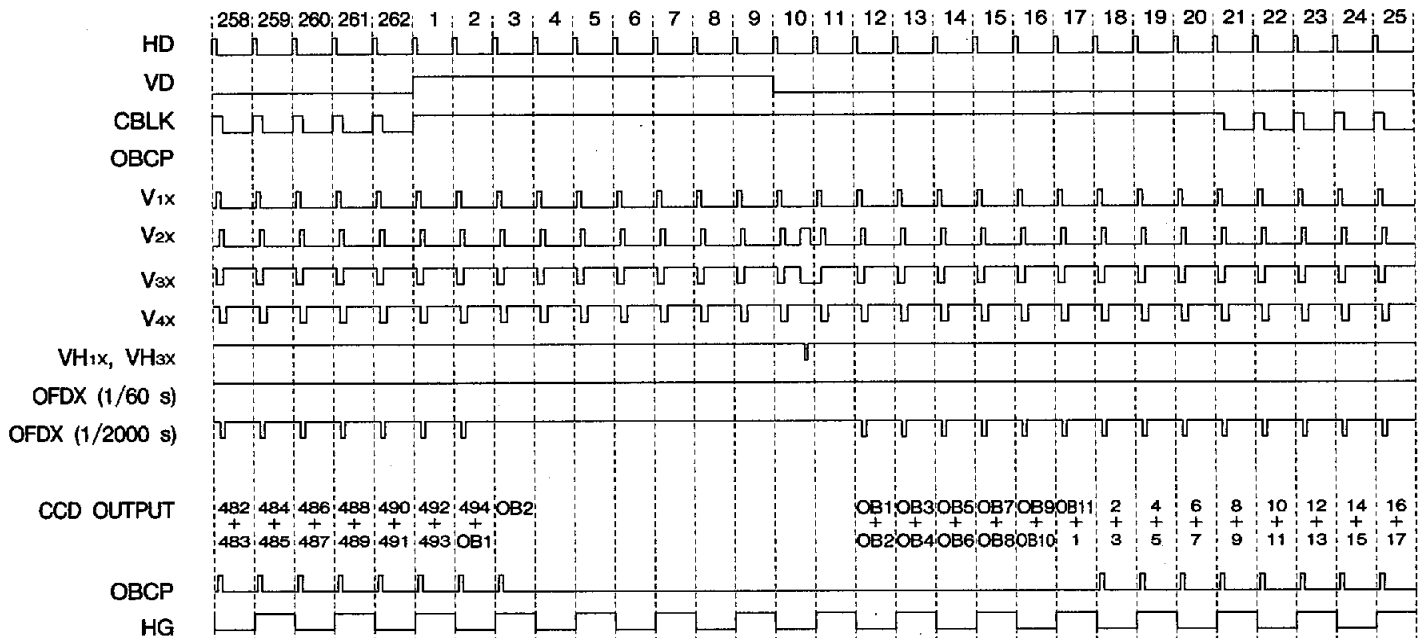

NON-INTERLACE MODE (cont'd)
 VERTICAL PULSE FOR DRIVING CCD < PAL >

