

KK2411N/D

Tone Ringer

The KK2411 is a bipolar integrated circuit designed for telephone bell replacement.

- Designed for Telephone Bell Replacement
- Low Current Drain
- Adjustable 2-frequency Tone
- Adjustable Warbling Rate
- Extension Tone Ringer Modules
- Alarms or Other Alerting Devices
- Adjustable for Reduced Supply Initiation Current.
- Built-in hysteresis prevents false triggering and rotary dial 'Chirps'

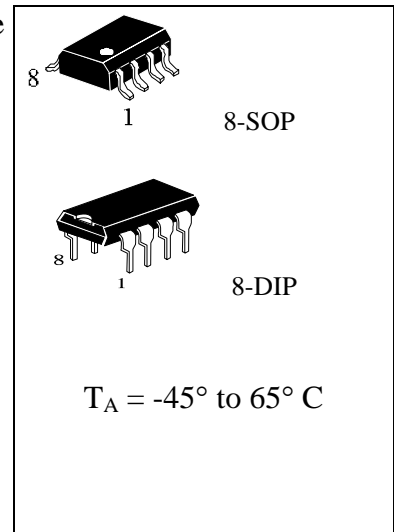

LOGIC DIAGRAM

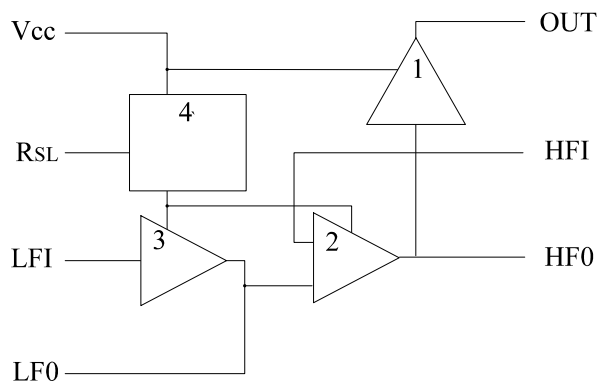

PIN 1 = V_{CC}
PIN 5 = GND

1. Output amplifier
2. High frequency oscillator
3. Low frequency oscillator
4. Hysteresis regulator
(Regulator circuit has built-in hysteresis to prevent false triggering and rotary dial "Chirps")

PIN ASSIGNMENT

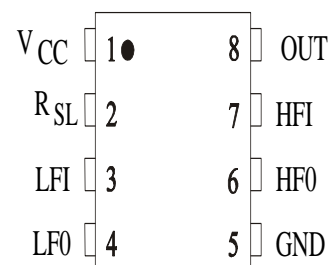

PIN DESCRIPTION

Name	Pin	Description
V _{CC}	1	Positive power supply.
R _{SL}	2	External resistor
LFI	3	Input low frequency oscillator
LF0	4	Output low frequency oscillator
GND	5	Negative power supply
HF0	6	High frequency oscillator output
HFI	7	High frequency oscillator input
Out	8	Tone output

MAXIMUM RATINGS*

Symbol	Parameter	Value	Unit
V _{CC}	DC Supply Voltage (Referenced to GND)	to +30.0	V
P _D	Power Dissipation in Still Air, Plastic DIP	400	mW
T _{stg}	Storage Temperature	-65 to +150	°C

* Maximum Ratings are those values beyond which damage to the device may occur. Functional operation should be restricted to the Recommended Operating Conditions.

RECOMMENDED OPERATING CONDITIONS

Symbol	Parameter	Min	Max	Unit
V _{CC}	DC Supply Voltage (Referenced to GND)	13.0	29.0	V
T _A	Operating Temperature	-45	+65	°C

This device contains protection circuitry to guard against damage due to high static voltages or electric fields. However, precautions must be taken to avoid applications of any voltage higher than maximum rated voltages to this high-impedance circuit. For proper operation, V_{IN} and V_{OUT} should be constrained to the range GND ≤ (V_{IN} or V_{OUT}) ≤ V_{CC}.

Unused inputs must always be tied to an appropriate logic voltage level (e.g., either GND or V_{CC}). Unused outputs must be left open.

ELECTRICAL CHARACTERISTICS (Voltages Referenced to GND, $T_A = -20$ to $+70^\circ\text{C}$)

Symbol	Parameter	Test Conditions	Guaranteed Limits			Unit
			Min	Typ	Max	
V_{SI}	Initiation Supply Voltage (1)	See Figure 1	16.8		21.2	V
I_{SI}	Initiation Supply Current (1)		1.4		4.2	mA
V_{SUS}	Sustaining Voltage (2)	See Figure 1	9.5		12.2	V
I_{SUS}	Sustaining Current (2)	No Load $V_{CC}=V_{SUS}$ See Figure 1	0.7		2.5	mA
V_{OH}	High-Level Output Voltage	$V_{CC}=21\text{V}$, $I_{OH}=-15\text{mA}$, Pin 6=6V, Pin 7=GND	16.7		21.0	V
V_{OL}	Low-Level Output Voltage	$V_{CC}=21\text{V}$, $I_{OL}=15\text{mA}$, Pin 6=GND, Pin 7=6V	-		1.8	V
I_{IN}	Maximum Input Leakage Current (Pin 3) (Pin 7)	Pin 3=6V, Pin 4=GND, $V_{CC}=21\text{V}$	-		1.0	μA
		Pin 7=6V, Pin 6=GND, $V_{CC}=21\text{V}$	-		1.0	μA
f_{H1}	High Frequency 1	$R_3=191\text{K}\Omega$, $C_3=6800\text{pF}$	461		563	Hz
f_{H2}	High Frequency 2	$R_3=191\text{K}\Omega$, $C_3=6800\text{pF}$	576		704	Hz
f_L	Low Frequency	$R_2=165\text{K}\Omega$, $C_2=0.47\mu\text{F}$	9.0		11.0	Hz

Notes:

1. Initiation supply voltage (V_{SI}) is the supply voltage required to start the tone ringer oscillating.
2. Sustaining voltage (V_{SUS}) is the supply voltage required to maintain oscillation.

CIRCUIT CURRENT-SUPPLY VOLTAGE (NO LOAD)

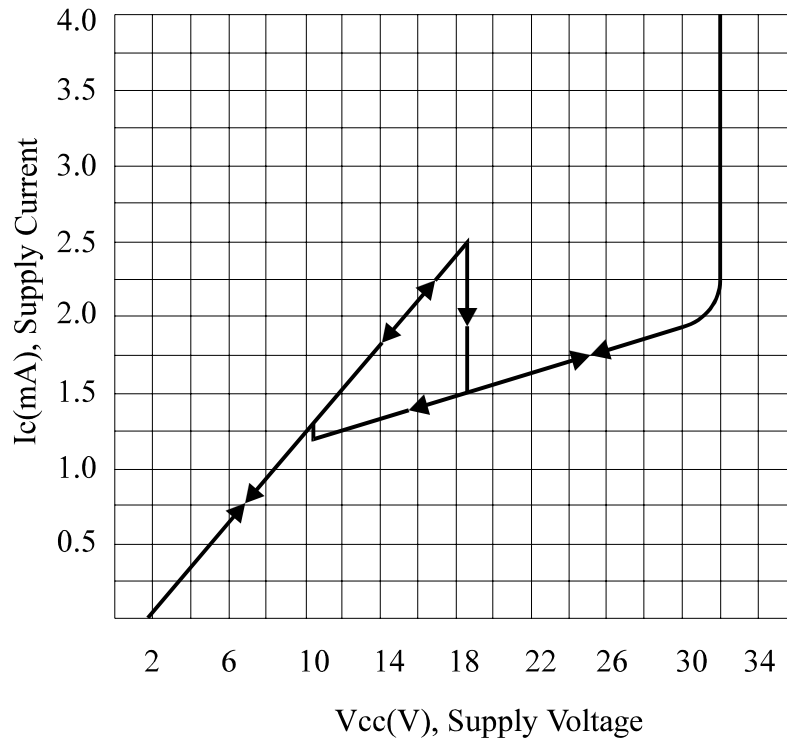

Figure 1

SUPPLY CURRENT (NO LOAD) VC. SUPPLY VOLTAGE

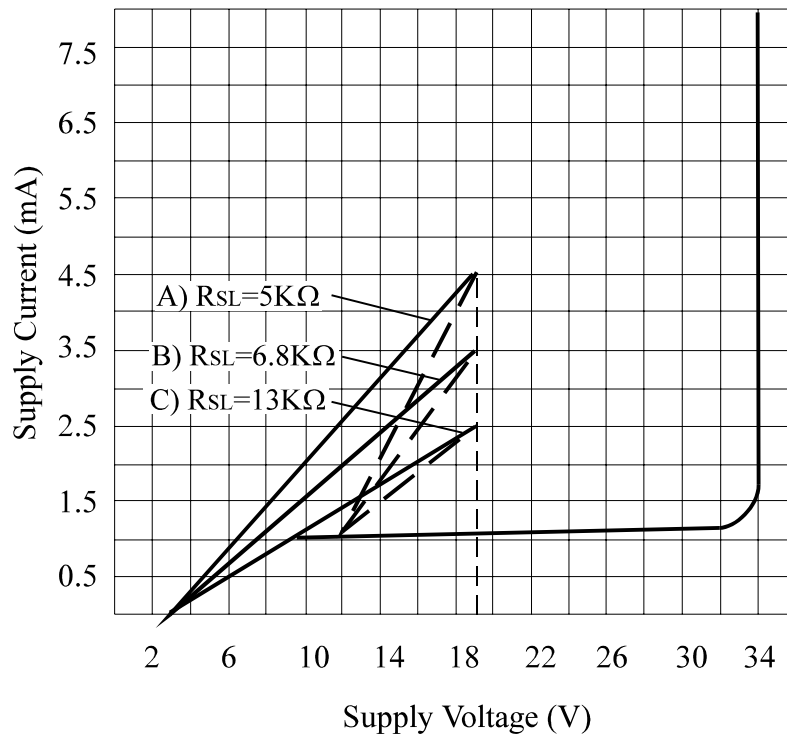

Figure 2

APPLICATION CIRCUIT

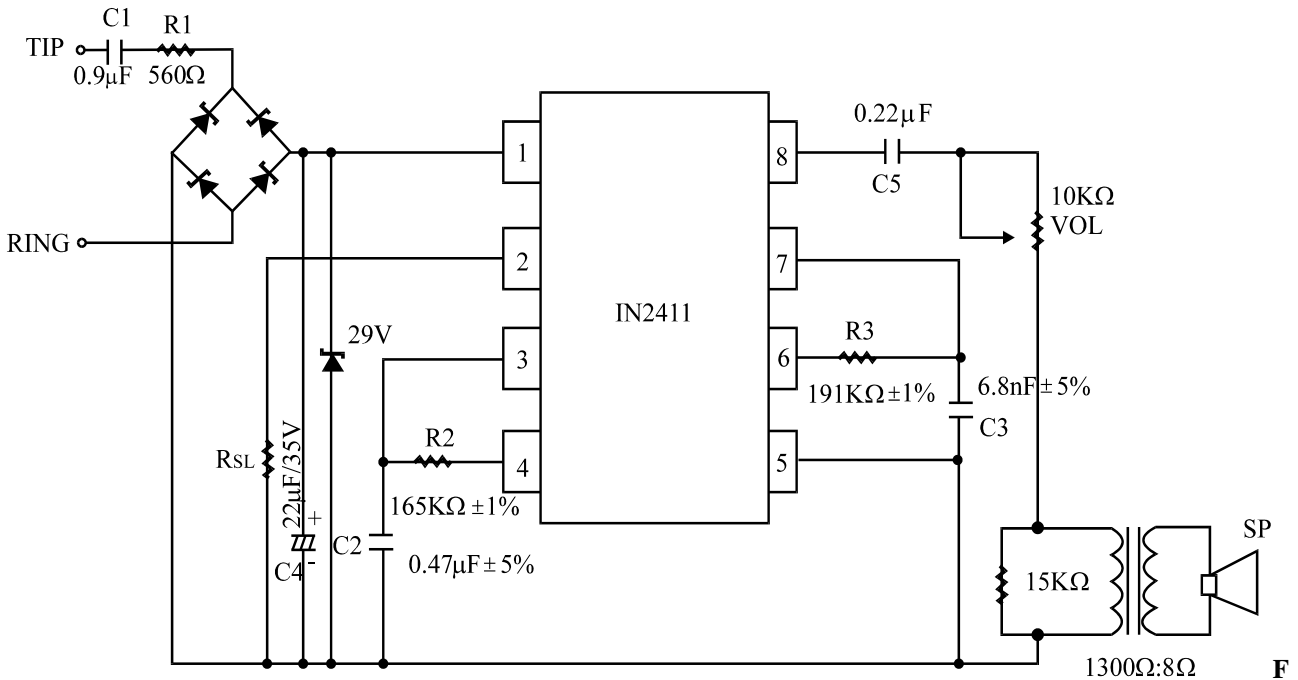

figure 3

APPLICATION NOTE

The application circuit illustrates the use of the KK2411 devices in typical telephone or extension tone ringer application. The AC ringer signal voltage appears across the TIP and RING inputs of the circuit and is attenuated by capacitor C₁ and resistor R₁.

C₁ also provides isolation from DC voltages (48V) on the exchange line.

After full wave rectification by the bridge diode, the waveform is filtered by capacitor C₄ to provide a DC supply for the tone ringer chip.

As this voltage exceeds the initiation voltage (V_{SI}), oscillation starts.

With the components shown, the output frequency chops between 512(f_{H1}) and 640Hz(f_{H2}) at a 10Hz(f_L) rate.

The loudspeaker load is coupled through a 1300Ω to 8Ω transformer.

The output coupling capacitor C₅ is required with transformer coupled loads.

When driving a piezo-ceramic transducer type load, the coupling C₅ and transformer (1300Ω:8Ω) are not required.

However, a current limiting resistor is required.

The low frequency oscillator oscillates at a rate (f_L) controlled by an external resistor (R₂) and capacitor (C₂).

The frequency can be determined using the relation $f_L = 1/1.289R_2 * C_2$. The high frequency oscillates at a f_{H1}, f_{H2}

controlled by an external resistor (R₃) and capacitor (C₃). The frequency can be determined using the relation

$f_{H1} = 1/1.504R_3 * C_3$, $f_{H2} = 1/1.203R_3 * C_3$.

Pin 2 allows connection of an external resistor R_{SL}, which is used to program the slope of the supply current vs supply voltage characteristics (see Fig2), and hence the supply current up to the initiation voltage (V_{SI}). This initiation voltage remains constant independent of R_{SL}.

The supply current drawn prior to triggering varies inversely with R_{SL}, decreasing for increasing value of resistance.

Thus, increasing the value of R_{SL} will decrease the amount of AC ringing current required to trigger the device. As such, longer subscriber loops are possible since less voltage is dropped per unit length of loop wire due to the lower current level. R_{SL} can also be used to compensate for smaller AC coupling capacitors (C₅ on Fig 3) (higher impedance) to the line which can be used to alter the ringer equivalence number of a tone ringer circuit.

The graph in Fig2 illustrates the variation of supply current with supply voltage. Three curves are drawn to show the variation of initiation current with R_{SL}. Curve B (R_{SL}=6.8KΩ) shows the I-V characteristic for the KK2411 tone ringer.

Curve A is a plot with R_{SL}<6.8KΩ and shows an increase in the current drawn up to the initiation voltage V_{SI}. The I-V characteristic after initiation remains unchanged. Curve C illustrates the effect of increasing R_{SL} above 6.8KΩ initiation current decreases but again current after triggering is unchanged.

**N SUFFIX PLASTIC DIP
(MS - 001BA)**

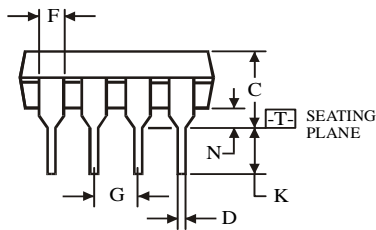
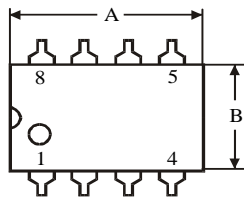
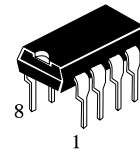

$\oplus 0.25 (0.010) \text{ (M) T}$

Symbol	Dimension, mm	
	MIN	MAX
A	8.51	10.16
B	6.1	7.11
C		5.33
D	0.36	0.56
F	1.14	1.78
G	2.54	
H	7.62	
J	0°	10°
K	2.92	3.81
L	7.62	8.26
M	0.2	0.36
N	0.38	

NOTES:

- Dimensions "A", "B" do not include mold flash or protrusions.
Maximum mold flash or protrusions 0.25 mm (0.010) per side.

**D SUFFIX SOIC
(MS - 012AA)**

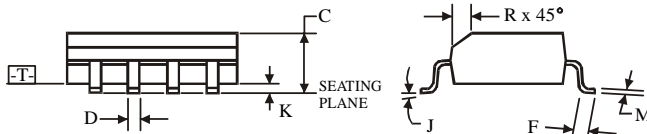
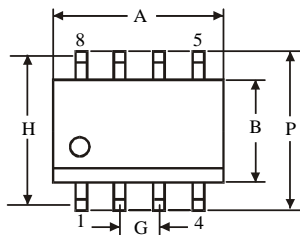
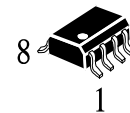

$\oplus 0.25 (0.010) \text{ (M) T C (M)}$

Symbol	Dimension, mm	
	MIN	MAX
A	4.8	5
B	3.8	4
C	1.35	1.75
D	0.33	0.51
F	0.4	1.27
G	1.27	
H	5.72	
J	0°	8°
K	0.1	0.25
M	0.19	0.25
P	5.8	6.2
R	0.25	0.5

NOTES:

- Dimensions A and B do not include mold flash or protrusion.
- Maximum mold flash or protrusion 0.15 mm (0.006) per side for A; for B - 0.25 mm (0.010) per side.