

Description

The iT3010E is a RoHS-6-compliant packaged differential amplifier designed for use in 10.7 Gb/s and 12.5 Gb/s (OC-192) optical transmitters and receivers as a gain stage with limiting functionality. It allows single-ended input signals from 350 mVpp up to 900 mVpp, or differential signals from 250 mVpp to 1800 mVpp to be limited at a constant differential output voltage of 3.8 Vpp. The iT3010E can be used as predriver for OC-192 optical modulator driver amplifiers. Output voltage control and external offset correction are provided. The amplifier also provides excellent linear performance when operating at lower output voltage. Both AC and DC input coupling are allowed. DC-coupled SCFL differential input (input HIGH voltage = 0 V, and input LOW voltage = -900 mV) are allowed.

Features

- Limiting function with 3.8 Vpp differential output
- 3 dB Bandwidth: 10 GHz
- Differential gain: 23.5 dB
- Standard bias supply: -5 V or -5.2V, +5 V
- Power consumption: 855 mW
- <1% total harmonic distortion at Pout = 0 dBm
- Low group delay
- Low jitter
- Output voltage control
- AC and DC input coupling (SCFL compatible)
- AC and DC output coupling
- RoHS-6-compliant 4x4 mm QFN (MO-220) package

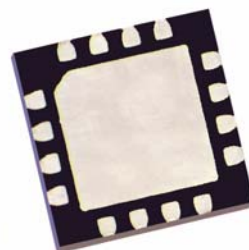

Absolute Maximum Ratings

Symbol	Parameters/conditions	Min.	Max.	Units
Vee	Power supply voltage	-8	0	V
Vcc	Power supply voltage	0	8	V
Vd	Applied voltage at data input (differential)		3	V
Vm	Applied voltage at data input (single ended)		1.5	V
I _{DCin} (+),(-)	Offset control current		5	mA
Tch	Maximum channel temperature		150	°C
Tstg	Storage temperature	-65	150	°C

Recommended Operating Conditions

Symbol	Parameters/conditions	Min.	Typ.	Max.	Units
Tc	Operating temperature range (Tcase)	0		85	°C
Vee	Negative power supply voltage	-5.45	-5	-4.75	V
Vcc	Positive power supply voltage	4.75	5	5.25	V
Vcb2	First internal bias control voltage		0		V
I _{ee}	Negative supply current	86	101	116	mA
I _{cc}	Positive supply current	60	70	81	mA
V _{DCin}	Offset control voltage	-5		5	V
Vctrl	Voltage control pin	-2.7		0	V
Vm	Applied peak-peak voltage at data input (single ended)	350		900	mV
Vd	Applied peak-peak voltage at data input (differential)	250		1800	mV
Vindc	DC input voltage (with DC-coupled input)	-0.5		0	V
R	Data bit rate			12.5	Gb/s



Electrical Characteristics

At ambient temperature

V_{ee} = -5 V
V_{cc} = +5 V

Symbol	Parameters/Conditions	Min.	Typ.	Max.	Units
P	Power consumption	730	855	985	mW
Z _{DCin}	Input impedance at DCin, /DCin	900	1000	1100	Ohm
G	Differential small signal gain	22.5	23.5		dB
B _{3dB}	3 dB bandwidth	9	10		GHz
RL _{in}	Input return loss (up to 10 GHz)	15	20		dB
RL _{out}	Output return loss (up to 10 GHz)	8	10		dB
V _{out}	Output peak-peak voltage (differential) (V _{ctrl} = -2.7V for max. output voltage)	3.5	3.8		V
ΔV _{out}	V _{out} sensitivity vs Bias (V _{ee} = -5 V +/-5%, V _{cc} = 5 V +/-5%)			+/-11	%
V _{outdc}	DC output voltage (DC coupled to 50 ohm load)	100	200	300	mV
Tr _{se}	Output rise time (single ended at maximum output voltage)		28	35	ps
Tf _{se}	Output fall time (single ended at maximum output voltage)		22	28	ps
J _{RMS}	RMS jitter degradation (*)		1	1.7	ps

$$(*) J_{RMS} = \sqrt{(J_{RMS_dut})^2 - (J_{MRS_thru})^2}$$

S-Parameter Data

Measured on connectorized evaluation board

V_{ee} = -5 V, V_{cc} = +5 V

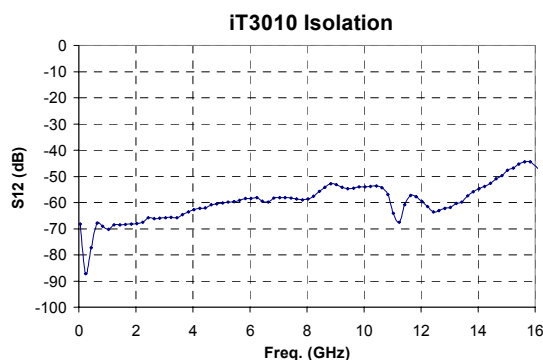
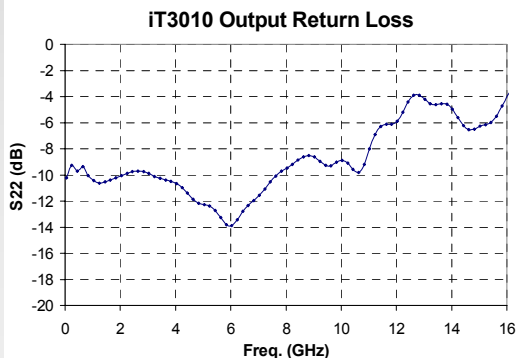
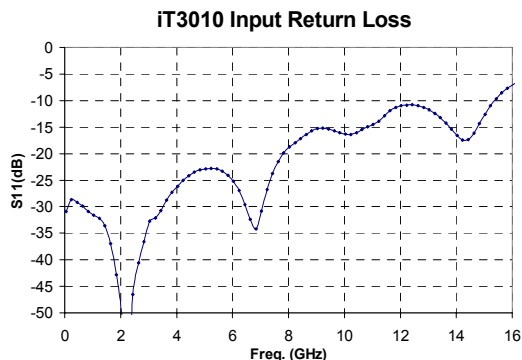
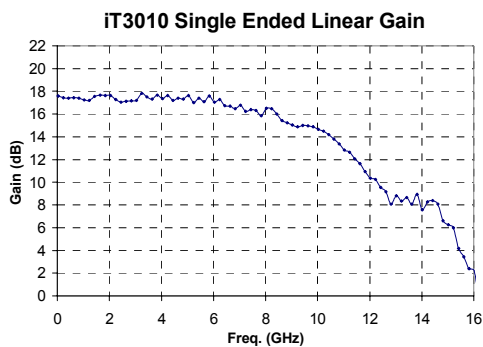

Eye Diagram Performance

Vee = -5 V
Vcc = +5 V

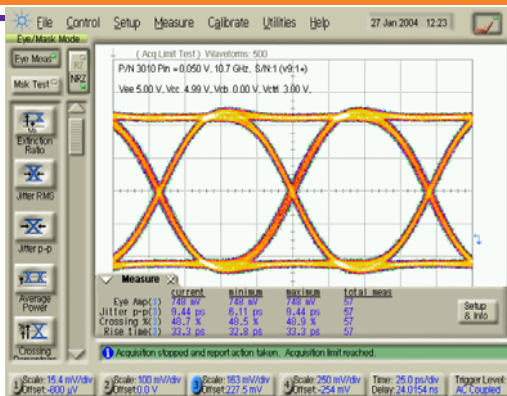

Linear performance
Bit rate: 10.7 Gb/s
Vin=+/-50 mVpp, Vout=+/-750 mVpp

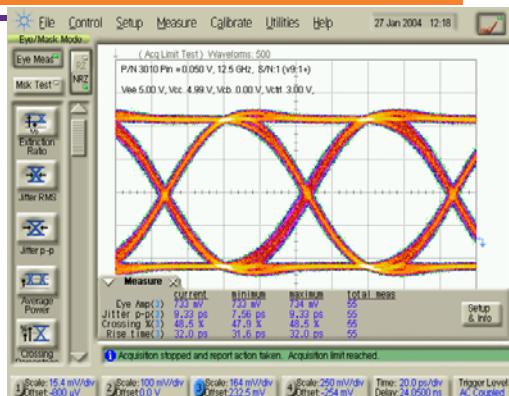

Linear performance
Bit rate: 12.5 Gb/s
Vin=+/-50 mVpp, Vout=+/-750 mVpp

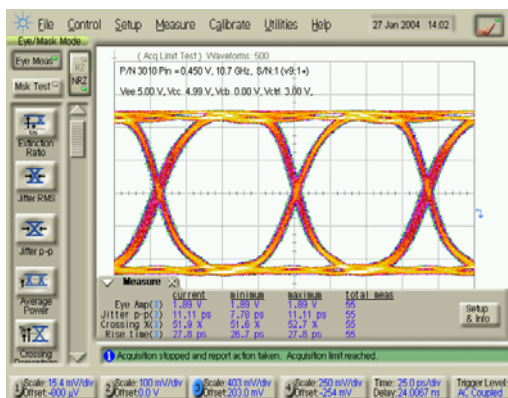

Saturated performance
Bit rate: 10.7 Gb/s
Vin=+/-450 mVpp, Vout=+/-1.9 Vpp

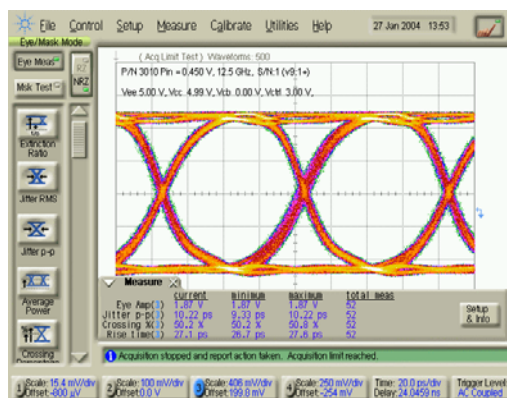

Saturated performance
Bit Rate: 12.5 Gb/s
Vin=+/-450 mVpp, Vout=+/-1.9 Vpp

Voltage Control

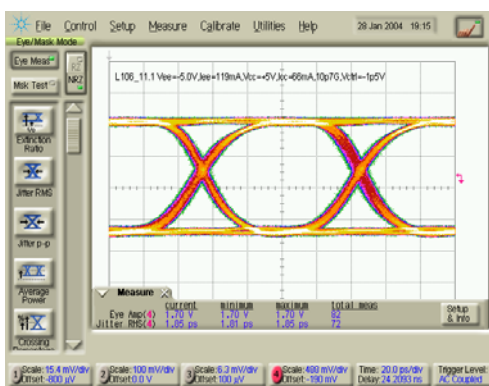

Bit rate: 10.7 Gb/s
Vctrl=-1.5 V, Vout=1.7 Vpp

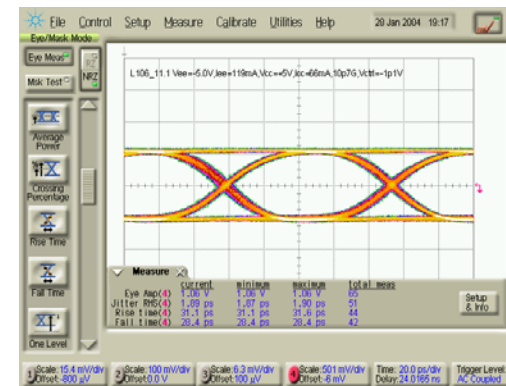

Bit rate: 10.7 Gb/s
Vctrl=-1.1V, Vout=1.0 Vpp



Performance As Function of Input Voltage

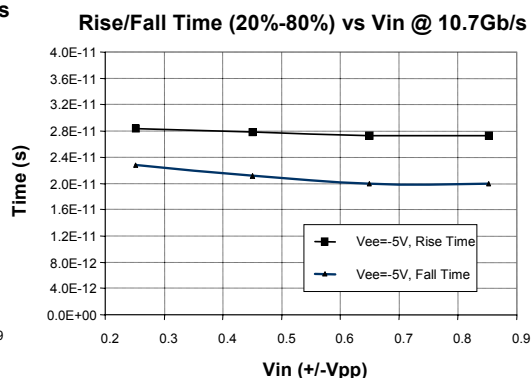
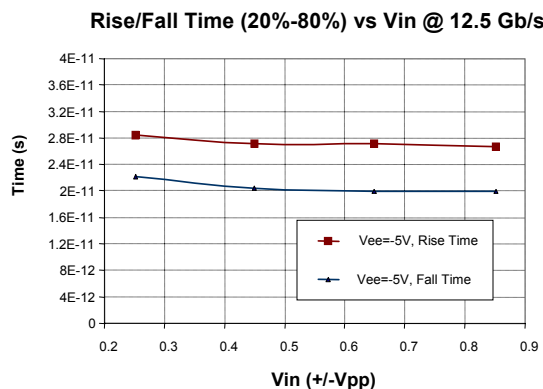
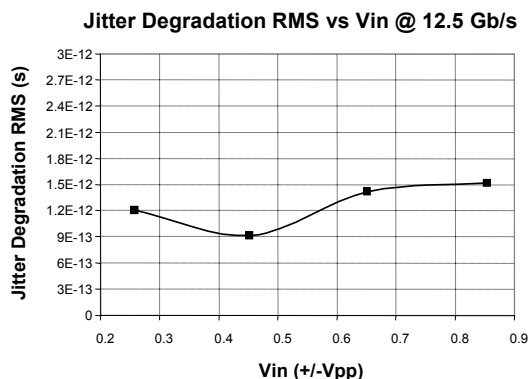
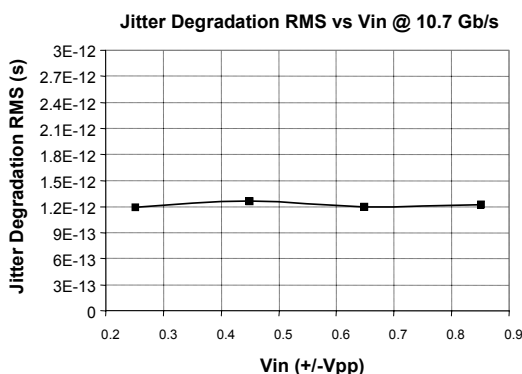
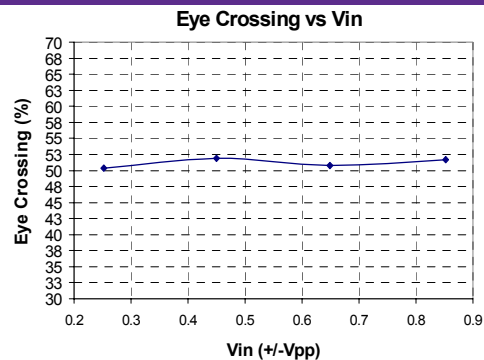
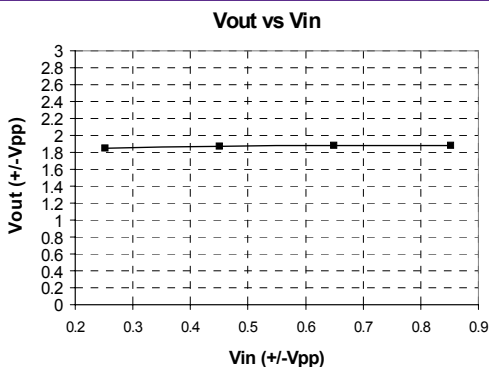

Power Performance And Harmonic Distortion

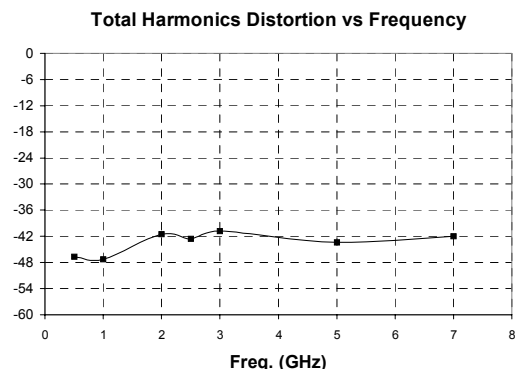
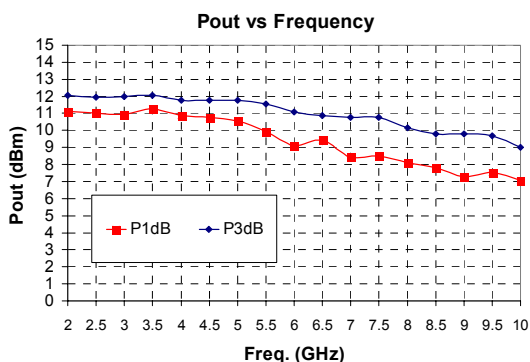

Vee = -5 V, Vcc = +5 V, Iee = 105 mA, Icc = 65 mA

At Pout = 0 dBm. Vee = -5 V, Vcc = +5 V, Iee = 105 mA, Icc = 65 mA

Device Diagram

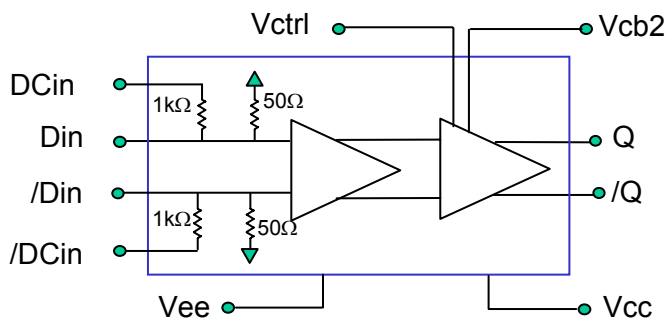

Recommended Operational Setup

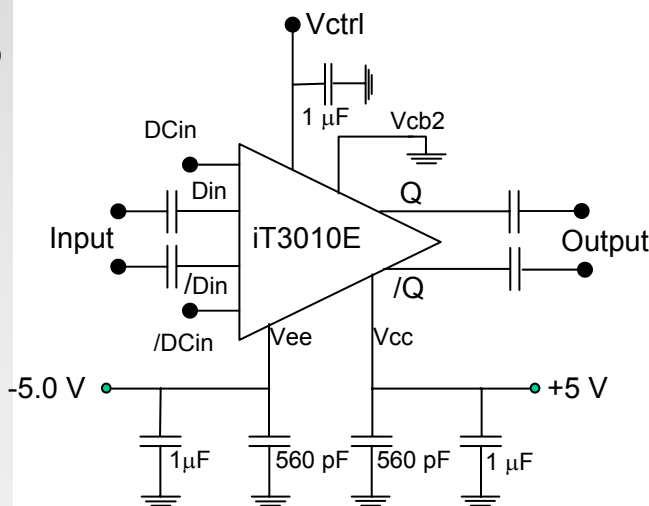

Bias Conditions

For Vee = -5V

- Apply +5.0 V at Vcc
- Apply -5 V at Vee
- Vcb2 = 0 V
- Vctrl = -2.7 V or open for maximum output voltage
- Vctrl from -2.7V to -1V for output voltage control

For Vee = -5.2 V bias application

- Apply +5 V at Vcc
- Apply -5.2 V at Vee
- Vcb2 = 0 V
- Vctrl = -1.8 V for maximum output voltage
- Vctrl from -1.8V to -1V for output voltage control



“E” Package Drawings, Pinouts, Marking

Notes:
Dimensions in inches [mm]

Tolerances are ± 0.0039 in. (0.100 mm)

Package drawing encompasses JEDEC MO-220 Version VGGC-2.

See iTerra Application Note 10 for recommended pad layout. RoHS parts are backward compatible if application note pad layout is followed.

Lead frame material is copper alloy.

Mold compound is UL94V0 compliant.

Lead finish is NiPdAu.

Marking Information
iTerra
MMMMEA
XXNNNN
LLYYWW

Where,
MMMM = part no.
E = Package Type
A = Temp. Range
XX = Wafer Lot
NNNN = Ser. No.
LLYYWW = MFG D/C

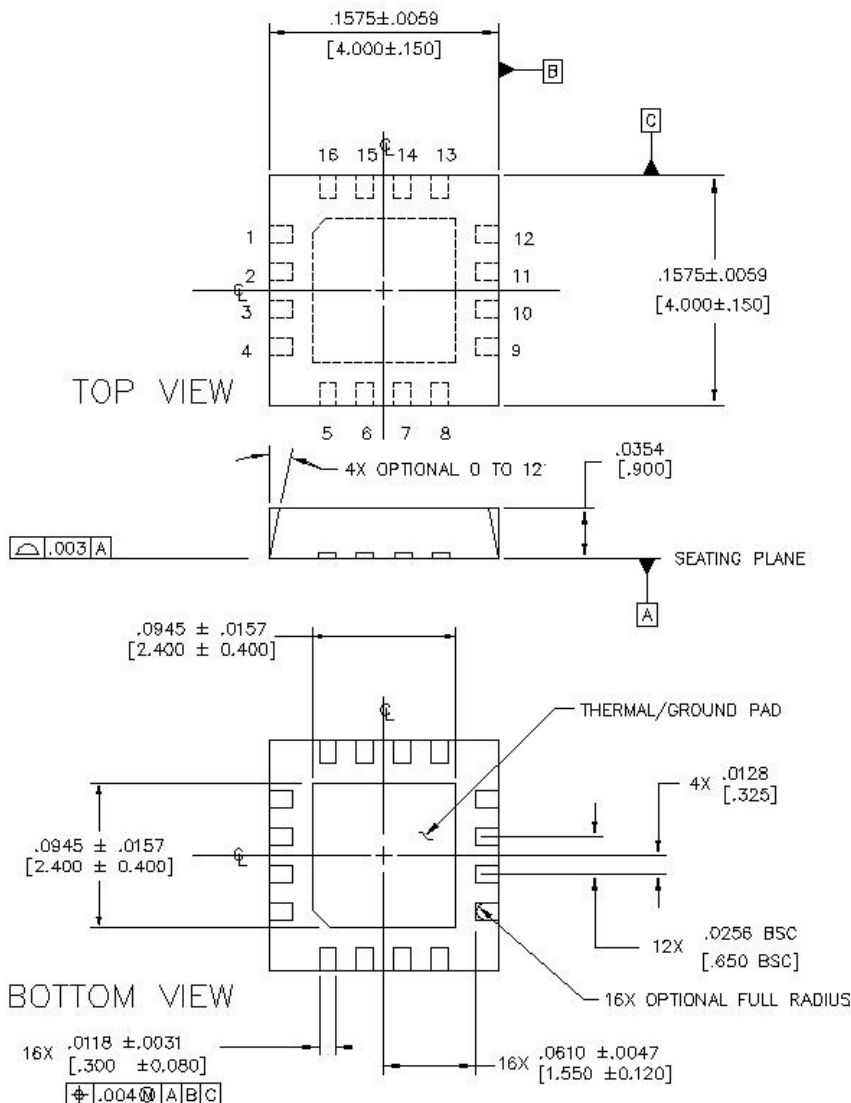

Pinouts

P1: GND	P9: GND
P2: Din (RF input)	P10: /Q (/RF Out)
P3: /Din (/RF input)	P11: Q (RF Out)
P4: GND	P12: GND
P5: /DCin	P13: Vcb2
P6: Vee	P14: Vctrl (voltage control)
P7: N/C	P15: Vcc
P8: N/C	P16: DCin

