

**OptiMOS<sup>®</sup> -T Power-Transistor**
**Features**

- N-channel - Enhancement mode
- Automotive AEC Q101 qualified
- MSL1 up to 260°C peak reflow
- 175°C operating temperature
- Green package (lead free)
- Ultra low R<sub>ds(on)</sub>
- Avalanche tested

**Product Summary**

$V_{DS}$	55	V
$R_{DS(on),max}$ (SMD version)	15.4	mΩ
$I_D$	45	A

PG-TO263-3-2

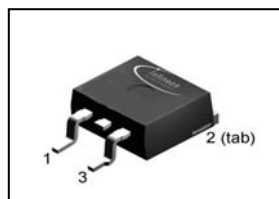

PG-TO262-3-1



PG-TO220-3-1

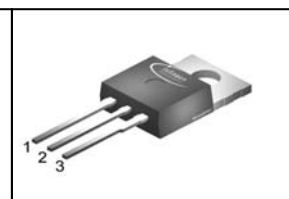

Type	Package	Ordering Code	Marking
IPB45N06S3-16	PG-TO263-3-2	SP0001-02224	3N0616
IPI45N06S3-16	PG-TO262-3-1	SP0001-02217	3N0616
IPP45N06S3-16	PG-TO220-3-1	SP0001-02218	3N0616

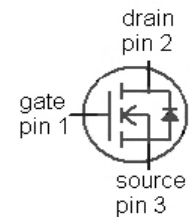
**Maximum ratings, at  $T_j=25\text{ °C}$ , unless otherwise specified**

Parameter	Symbol	Conditions	Value	Unit
Continuous drain current <sup>1)</sup>	$I_D$	$T_C=25\text{ °C}$ , $V_{GS}=10\text{ V}$	45	A
		$T_C=100\text{ °C}$ , $V_{GS}=10\text{ V}^{2)}$	33	
Pulsed drain current <sup>2)</sup>	$I_{D,pulse}$	$T_C=25\text{ °C}$	180	
Avalanche energy, single pulse <sup>3)</sup>	$E_{AS}$	$I_D=27.5\text{ A}$	95	mJ
Drain gate voltage <sup>2)</sup>	$V_{DG}$		55	
Gate source voltage <sup>4)</sup>	$V_{GS}$		±20	V
Power dissipation	$P_{tot}$	$T_C=25\text{ °C}$	65	W
Operating and storage temperature	$T_j, T_{stg}$		-55 ... +175	°C
IEC climatic category; DIN IEC 68-1			55/175/56	

Parameter	Symbol	Conditions	Values			Unit
			min.	typ.	max.	
<b>Thermal characteristics<sup>2)</sup></b>						
Thermal resistance, junction - case	$R_{thJC}$		-	-	2.3	K/W
Thermal resistance, junction - ambient, leaded	$R_{thJA}$		-	-	62	
SMD version, device on PCB	$R_{thJA}$	minimal footprint	-	-	62	
		6 cm <sup>2</sup> cooling area <sup>5)</sup>	-	-	40	

**Electrical characteristics, at  $T_j=25\text{ °C}$ , unless otherwise specified**
**Static characteristics**

Drain-source breakdown voltage	$V_{(BR)DSS}$	$V_{GS}=0\text{ V}, I_D=250\text{ }\mu\text{A}$	55	-	-	V
Gate threshold voltage	$V_{GS(th)}$	$V_{DS}=V_{GS}, I_D=30\text{ }\mu\text{A}$	2.1	3	4	
Zero gate voltage drain current	$I_{DSS}$	$V_{DS}=25\text{ V}, V_{GS}=0\text{ V}, T_j=25\text{ °C}$	-	0.1	1	$\mu\text{A}$
		$V_{DS}=25\text{ V}, V_{GS}=0\text{ V}, T_j=125\text{ °C}^{1)}$	-	1	100	
Gate-source leakage current	$I_{GSS}$	$V_{GS}=20\text{ V}, V_{DS}=0\text{ V}$	-	1	100	nA
Drain-source on-state resistance	$R_{DS(on)}$	$V_{GS}=10\text{ V}, I_D=23\text{ A}$	-	13.5	15.7	m $\Omega$
		$V_{GS}=10\text{ V}, I_D=23\text{ A},$ SMD version	-	13.2	15.4	

Parameter	Symbol	Conditions	Values			Unit
			min.	typ.	max.	

**Dynamic characteristics<sup>2)</sup>**

Input capacitance	$C_{iss}$	$V_{GS}=0\text{ V}, V_{DS}=25\text{ V},$ $f=1\text{ MHz}$	-	2980	-	pF
Output capacitance	$C_{oss}$		-	450	-	
Reverse transfer capacitance	$C_{rss}$		-	430	-	
Turn-on delay time	$t_{d(on)}$	$V_{DD}=27.5\text{ V},$ $V_{GS}=10\text{ V}, I_D=45\text{ A},$ $R_G=22\ \Omega$	-	28	-	ns
Rise time	$t_r$		-	61	-	
Turn-off delay time	$t_{d(off)}$		-	26	-	
Fall time	$t_f$		-	68	-	

**Gate Charge Characteristics<sup>2)</sup>**

Gate to source charge	$Q_{gs}$	$V_{DD}=11\text{ V}, I_D=45\text{ A},$ $V_{GS}=0\text{ to }10\text{ V}$	-	23	-	nC
Gate to drain charge	$Q_{gd}$		-	10	-	
Gate charge total	$Q_g$		-	43	57	
Gate plateau voltage	$V_{plateau}$		-	7.2	-	V

**Reverse Diode**

Diode continuous forward current	$I_S$	$T_C=25\text{ }^\circ\text{C}$	-	-	45	A
Diode pulse current <sup>2)</sup>	$I_{S,pulse}$		-	-	180	
Diode forward voltage <sup>2)</sup>	$V_{SD}$	$V_{GS}=0\text{ V}, I_F=45\text{ A},$ $T_J=25\text{ }^\circ\text{C}$	-	1.1	1.3	V
Reverse recovery time <sup>2)</sup>	$t_{rr}$	$V_R=27.5\text{ V}, I_F=I_S,$ $di_F/dt=100\text{ A}/\mu\text{s}$	-	-	-	ns
Reverse recovery charge <sup>2)</sup>	$Q_{rr}$	$V_R=27.5\text{ V}, I_F=I_S,$ $di_F/dt=100\text{ A}/\mu\text{s}$	-	-	-	nC

<sup>1)</sup> Current is limited by bondwire; with an  $R_{thJC} = 2.3\text{ K/W}$  the chip is able to carry 46A at 25°C. For detailed information see Application Note ANPS071E at [www.infineon.com/optimos](http://www.infineon.com/optimos)

<sup>2)</sup> Defined by design. Not subject to production test.

<sup>3)</sup> See diagrams 12 and 13.

<sup>4)</sup> Qualified at -5V and +20V.

<sup>5)</sup> Device on 40 mm x 40 mm x 1.5 mm epoxy PCB FR4 with 6 cm<sup>2</sup> (one layer, 70 μm thick) copper area for drain connection. PCB is vertical in still air.

**1 Power dissipation**

$P_{tot}=f(T_C); V_{GS} \geq 6 \text{ V}$

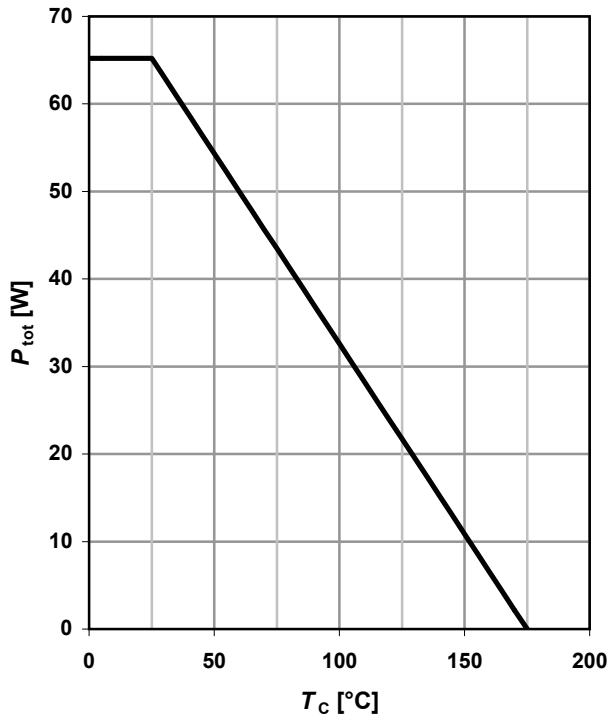

**2 Drain current**

$I_D=f(T_C); V_{GS} \geq 10 \text{ V}$

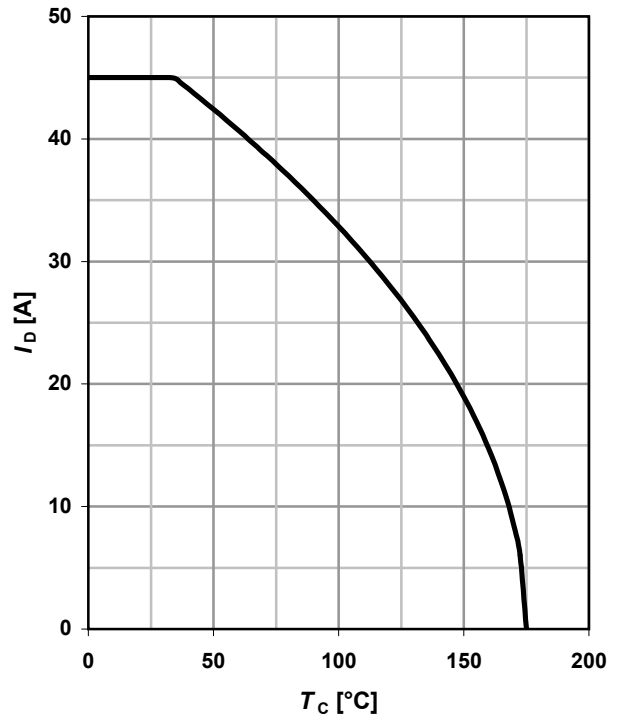

**3 Safe operating area**

$I_D=f(V_{DS}); T_C=25 \text{ °C}; D=0$

parameter:  $t_p$

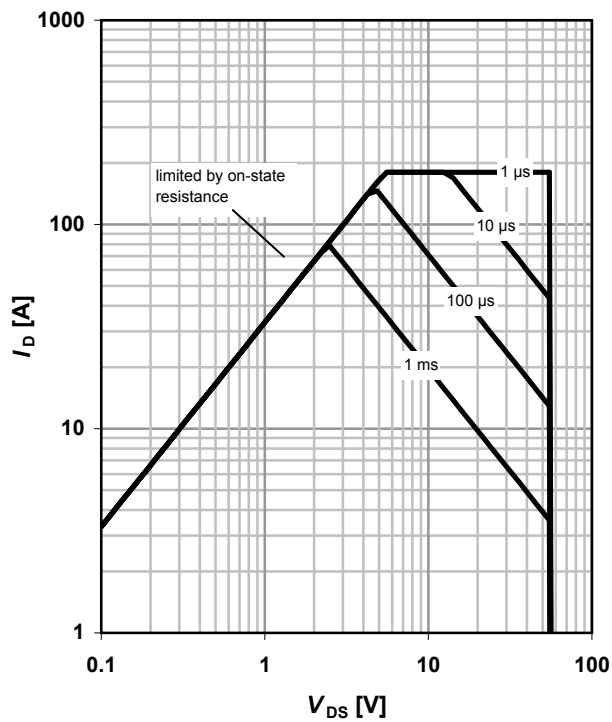

**4 Max. transient thermal impedance**

$Z_{thJC}=f(t_p)$

parameter:  $D=t_p/T$

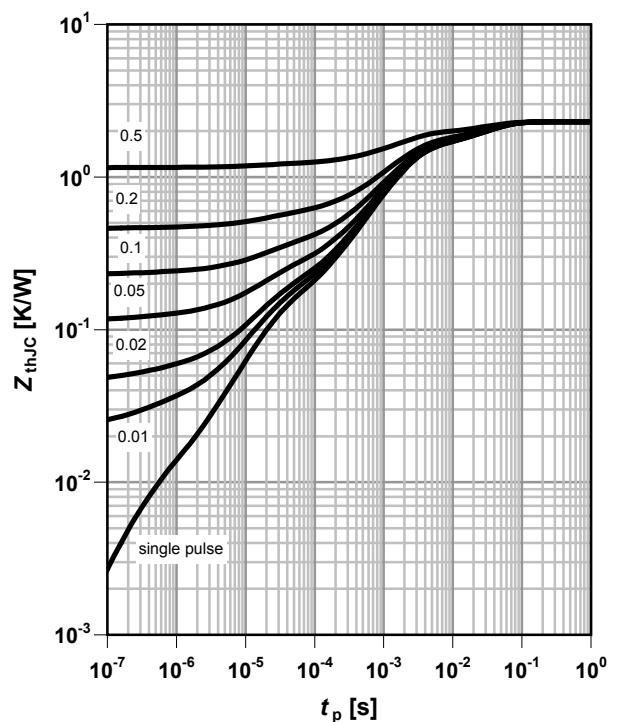

**5 Typ. output characteristics**

$I_D=f(V_{DS}); T_j=25\text{ }^\circ\text{C}$

parameter:  $V_{GS}$ , pulsed

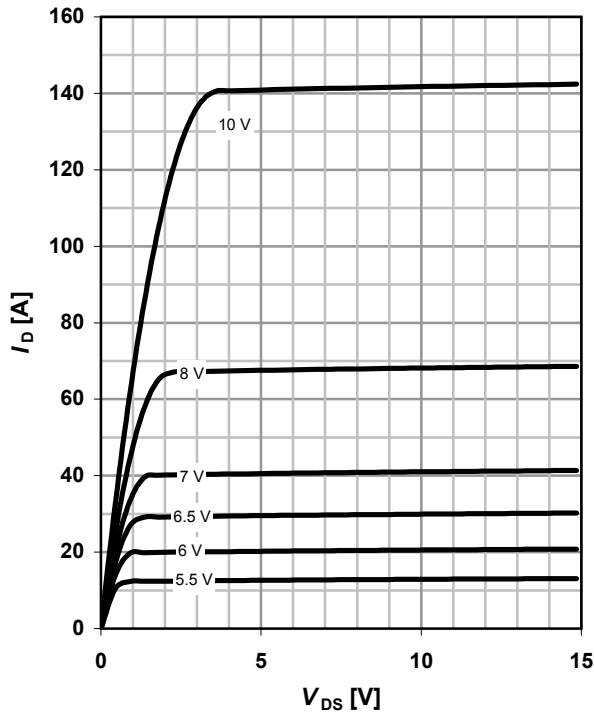

**6 Typ. drain-source on resistance**

$R_{DS(on)}=f(I_D); T_j=25\text{ }^\circ\text{C}$

parameter:  $V_{GS}$

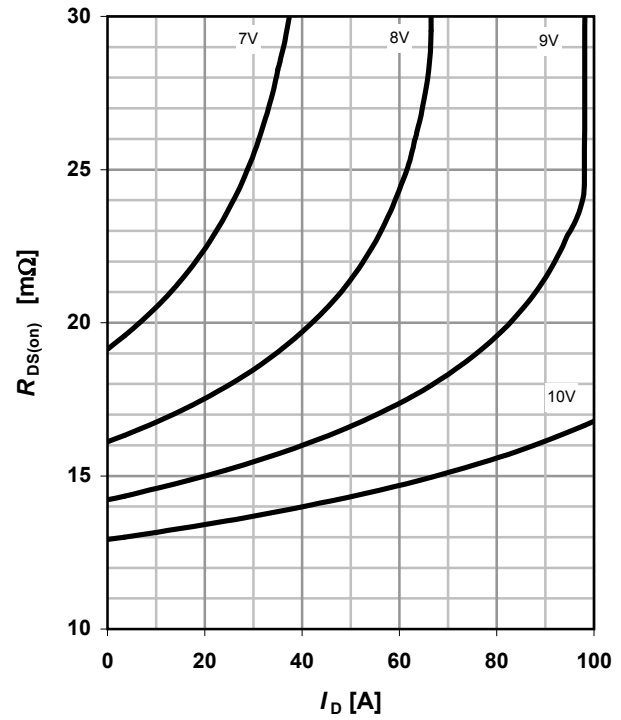

**7 Typ. transfer characteristics**

$I_D=f(V_{GS}); V_{DS}=10\text{ V}$

parameter:  $T_j$

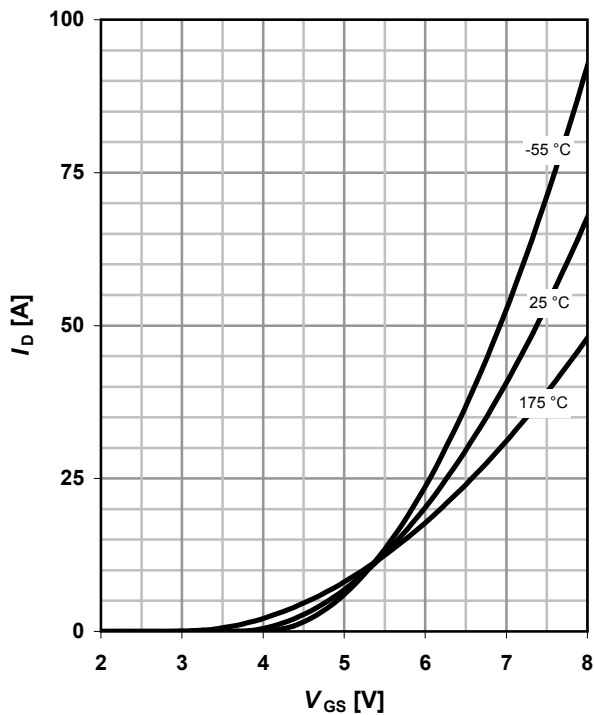

**8 Drain-source on-state resistance**

$R_{DS(on)}=f(T_j); I_D=20\text{ A}; V_{GS}=10\text{ V}$

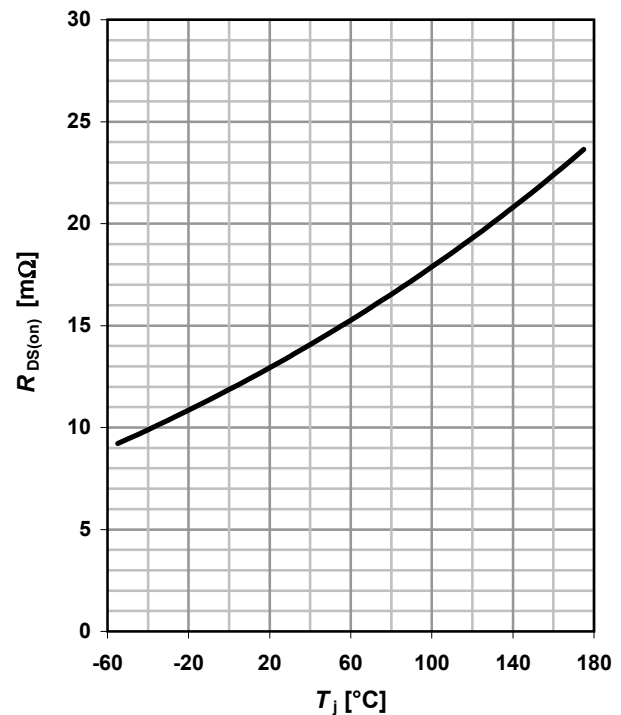

**9 Typ. gate threshold voltage**

$V_{GS(th)} = f(T_j); V_{GS} = V_{DS}$

parameter:  $I_D$

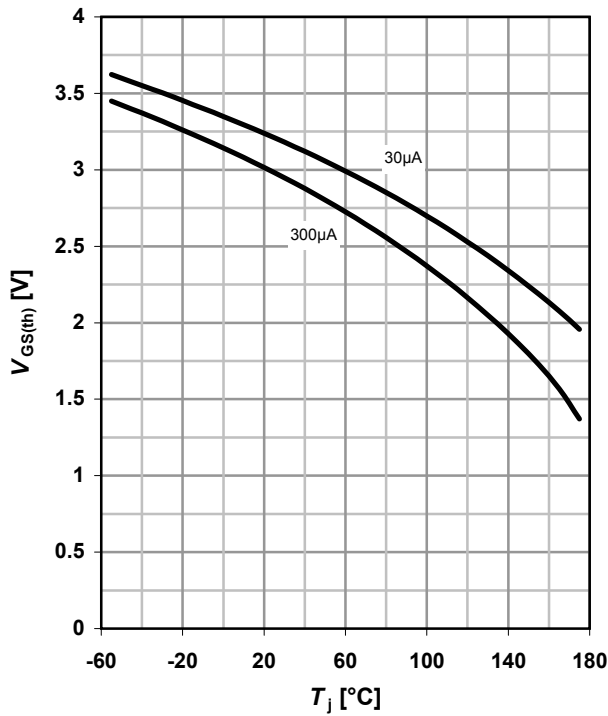

**10 Typ. capacitances**

$C = f(V_{DS}); V_{GS} = 0 V; f = 1 MHz$

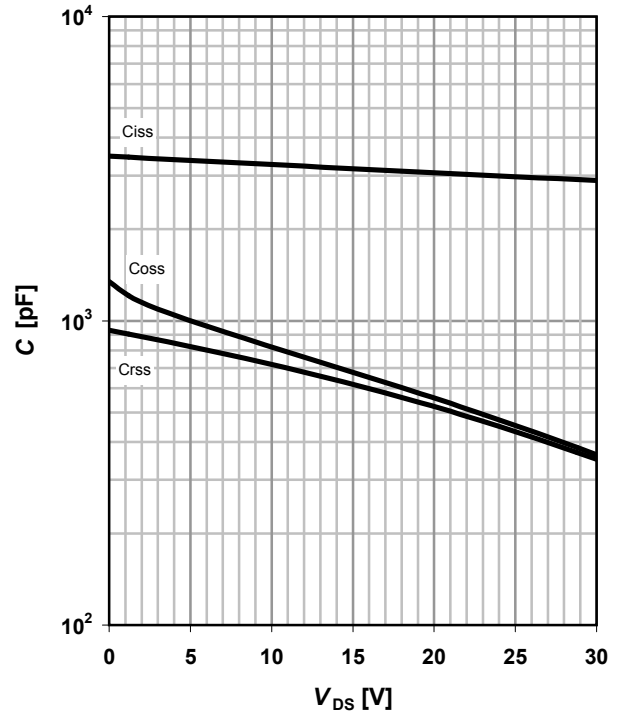

**11 Forward characteristics of reverse diode**

$I_F = f(V_{SD}), \text{ pulsed}$

parameter:  $T_j$

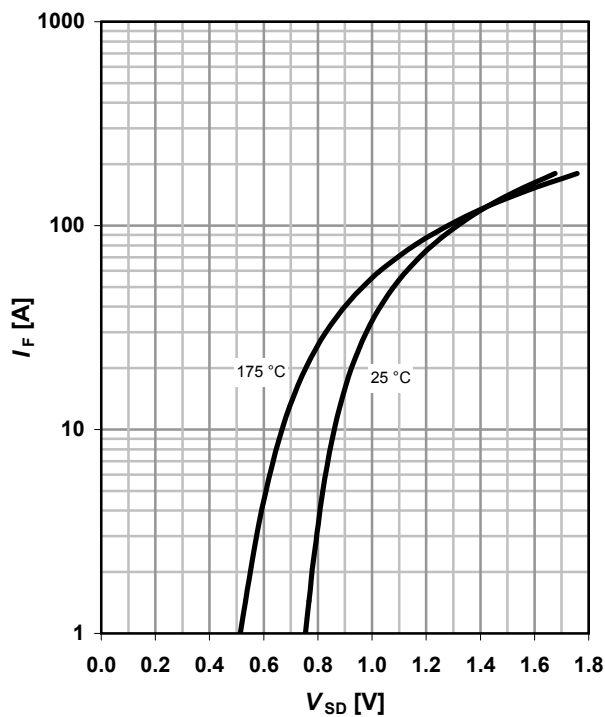

**12 Typ. avalanche characteristics**

$I_{AS} = f(t_{AV})$

parameter:  $T_{j(start)}$

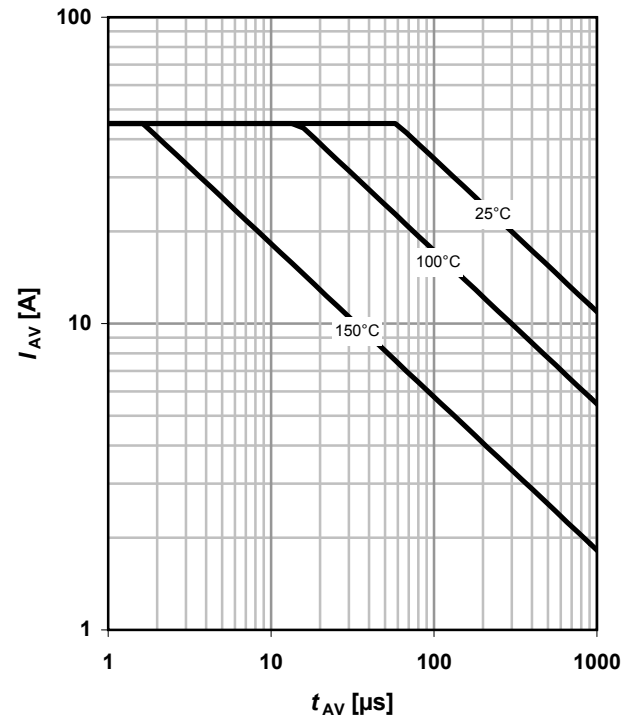

**13 Typ. avalanche energy**

$$E_{AS} = f(T_j)$$

parameter:  $I_D$

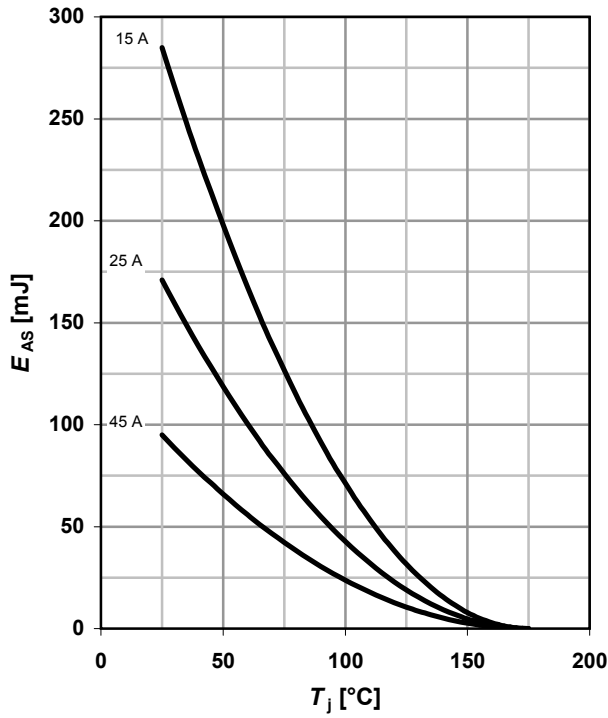

**15 Drain-source breakdown voltage**

$$V_{BR(DSS)} = f(T_j); I_D = 1 \text{ mA}$$

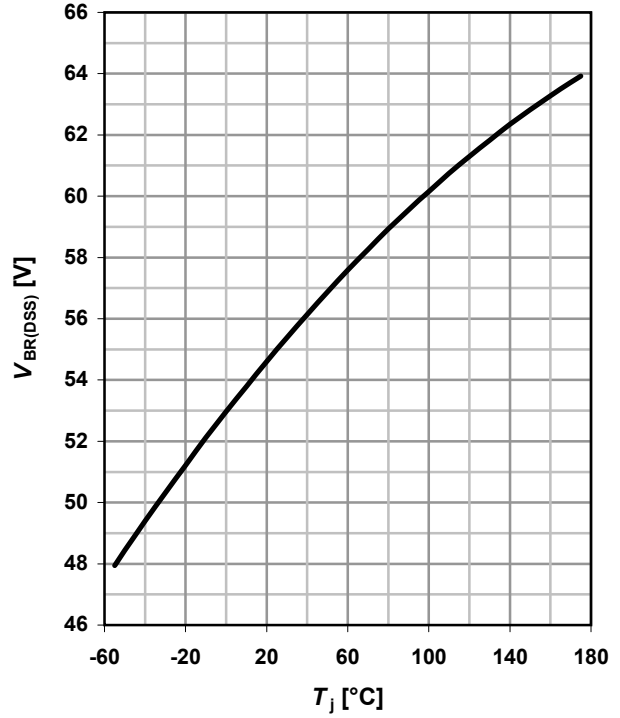

**14 Typ. gate charge**

$$V_{GS} = f(Q_{gate}); I_D = 45 \text{ A pulsed}$$

parameter:  $V_{DD}$

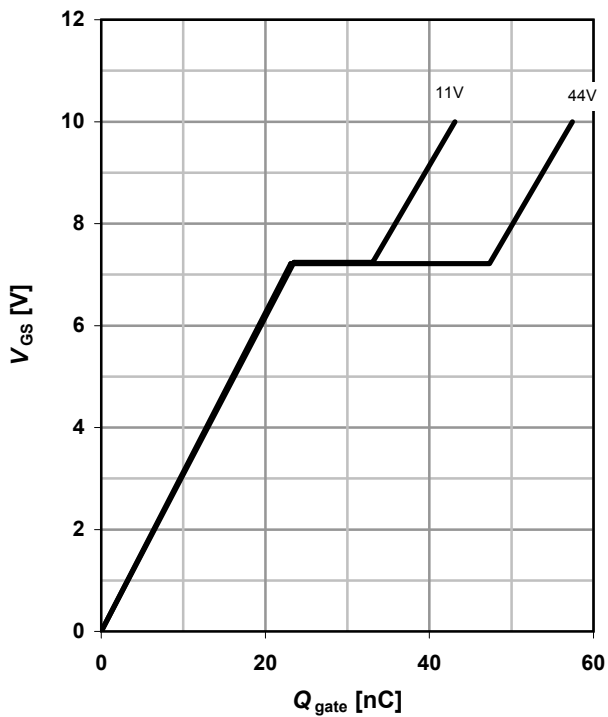

**16 Gate charge waveforms**

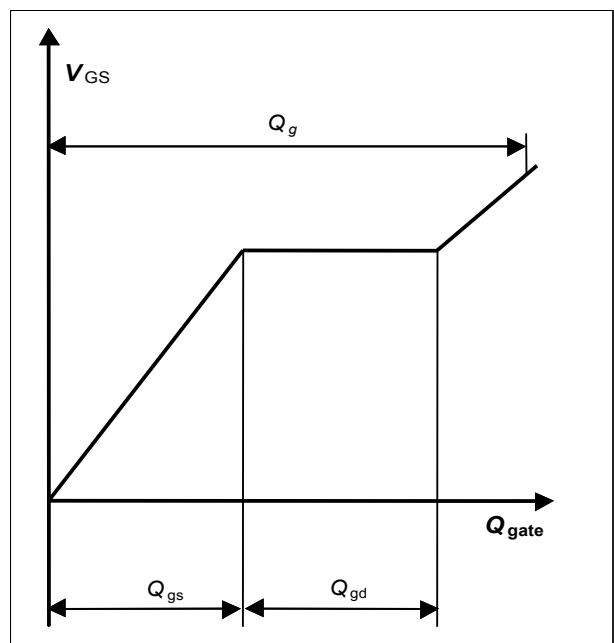

Package Outline

P-TO263-3-2: Outline

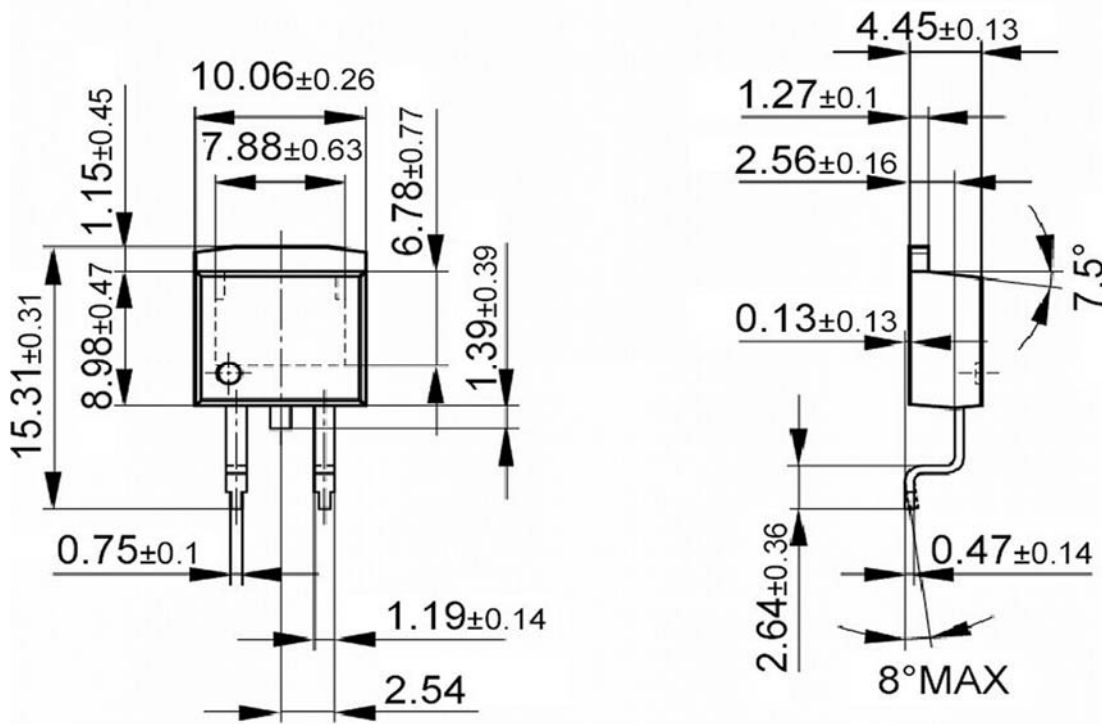

158

Footprint

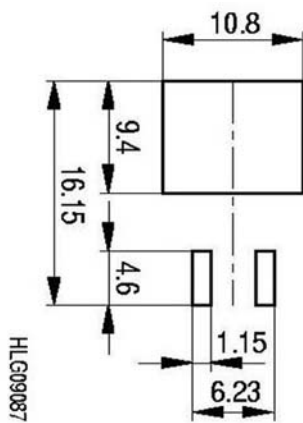

Packaging

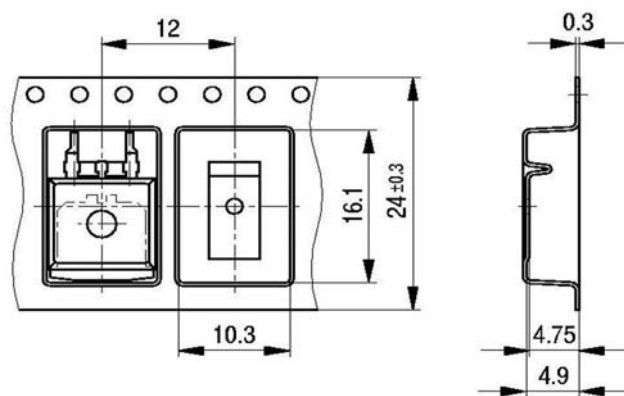

Dimensions in mm



**Published by**  
**Infineon Technologies AG**  
**St.-Martin-Straße 53**  
**D-81541 München**  
**© Infineon Technologies AG 2004**  
**All Rights Reserved.**

**Attention please!**

The information herein is given to describe certain components and shall not be considered as warranted characteristics.

Terms of delivery and rights to technical change reserved.

We hereby disclaim any and all warranties, including but not limited to warranties of non-infringement, regarding circuits, descriptions and charts stated herein.

Infineon Technologies is an approved CECC manufacturer.

**Information**

For further information on technology, delivery terms and conditions and prices, please contact your nearest Infineon Technologies office in Germany or our Infineon Technologies representatives worldwide (see address list).

**Warnings**

Due to technical requirements, components may contain dangerous substances.  
For information on the types in question, please contact your nearest Infineon Technologies office.

Infineon Technologies' components may only be used in life-support devices or systems with the expressed written approval of Infineon Technologies if a failure of such components can reasonably be expected to cause the failure of that life-support device or system, or to affect the safety or effectiveness of that device or system. Life support devices or systems are intended to be implanted in the human body, or to support and/or maintain and sustain and/or protect human life. If they fail, it is reasonable to assume that the health of the user or other persons may be endangered.