



SPECIFICATION

PART NO. 101111FHAVPM406ZA

DESCRIPTION. RJ45 1X1 TAB UP W/LED & TRANSFORMER

CUSTOMER. _____

REV. : P0

REV. DATE : 2006 / Aug / 24

	APPROVED	CHECKED	PREPARED
NAME	Kenny Chen	Bryant Tu	Nicole Lee

實盈股份有限公司

SUYIN CORPORATION

TAIWAN HEAD OFFICE :

NO. 377.Fu-The First Re., His-Chih,
Taipei Hsien, Taiwan, R.O.C.
TEL : (886) 2-2694-7697 (Rep)
FAX : (886) 2-2694-8407 2694-8047
E-mail : Lesley@suyin.com.tw

SUYIN ELECTRONICS (DONGGUAN) CO., LTD.

Suyin Road, San Zhong,
Qing Xi Town, Dongguan City,
TEL : (886) 2-2694-7697 (Rep)
FAX : (886) 2-2694-8407 2694-8047
E-mail : kevin@suyin.com.tw

HONG KONG BRANCH OFFICE :

TEL : (852) 2-559-6017
FAX : (852) 2-5596461
E-mail : suyin@netvigtor.com

KOREA BRANCH OFFICE :

TEL : (82) 2-559-6017
FAX : (82) 2-5596461
E-mail : yang@sdint.co.kr

GERMANY BRANCH OFFICE :

TEL : (+49) 0-8561/238-8880
FAX : (+49) 0-8561/238/8888
E-mail : mail@suyin.de

JAPAN BRANCH OFFICE :

TEL : (81) 45-266-2488
FAX : (81) 45-266-2489
E-mail : kanashiro@suyinjapan.com

SINGAPOER BRANCH OFFICE :

90 Lorong 23 Geylang #02-01/02/03 Yong
DA Industrial Building Singapore 388393
TEL : (65) 6256-6481
FAX : (65) 6256-6483
E-mail : alice@suyin.com.sg

U.S.A BRANCH OFFICE :

TEL : (1) 714-750-0378
FAX : (1) 714-750-0379
E-mail : steven@suyinusa.com

ISRAEL BRANCH OFFICE :

TEL : (1) 714-750-0378
FAX : (1) 714-750-0379
E-mail : sales@suyin.co.il

SUYIN CORPORATION

SPECIFICATION

DOCUMENT NO.: 101111FHAVPM406ZA SUYIN P/N. : 101111FHAVPM406ZA CUSTOMER P/N. :	DESC. : RJ45 1X1 TAB UP W/LED & TRANSFORMER
--	--

1 P/N SPECIFICATION

SUYIN P/N: **101 111 F** **H** **AV** **P** **M4** **06** **ZA**
A B C D E

A. Transformer Speed: **10/100/1000 Base-T**
 LED Polarity: **Normal**

B. Schematic: Refers to section 5.1

C. LED Color Code:

w/o LED: 0		RIGHT LED					
		YELLOW	GREEN	ORANGE	G/O	G/Y	O/G
LEFT LED	YELLOW	1	7	D	K	N	R
	GREEN	2	8	E	L	P	S
	ORANGE	3	9	F	M	Q	T
	G/O	4	A	G	/	/	/
	G/Y	5	B	H	/	/	/
	O/G	6	C	J	/	/	/

D. RJ Contact Plating:

- M2: Gold Flash selected Gold plating over 50 u" min. Nickel
- M3: 10u" selected Gold plating over 50 u" min. Nickel
- M4: 15u" selected Gold plating over 50 u" min. Nickel
- M5: 30u" selected Gold plating over 50 u" min. Nickel
- M6: 50u" selected Gold plating over 50 u" min. Nickel.

E. Mechanical Series: Refers to section 2.1~2.2

SUYIN CORPORATION

SPECIFICATION

DOCUMENT NO.: 101110FHAVPM406ZA SUYIN P/N. : 101110FHAVPM406ZA CUSTOMER P/N.:	DESC. : RJ45 1X1 TAB UP W/LED & TRANSFORMER
---	--

2 MECHANICAL DIMENSIONS

2-1 Dimensions

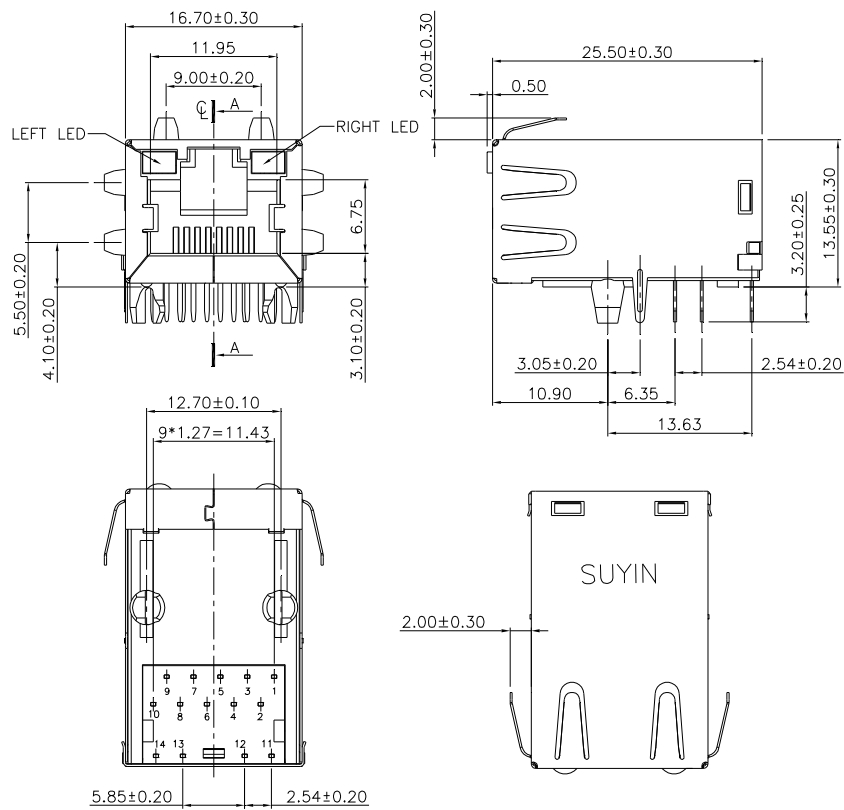

General Tolerance : 0~10mm: ±0.10
 10~30mm: ±0.20
 30~ mm: ±0.30

SUYIN CORPORATION

SPECIFICATION

DOCUMENT NO.: 101111FHAVPM406ZA SUYIN P/N. : 101111FHAVPM406ZA CUSTOMER P/N. :	DESC. : RJ45 1X1 TAB UP W/LED & TRANSFORMER
--	--

2-2 PCB Layout

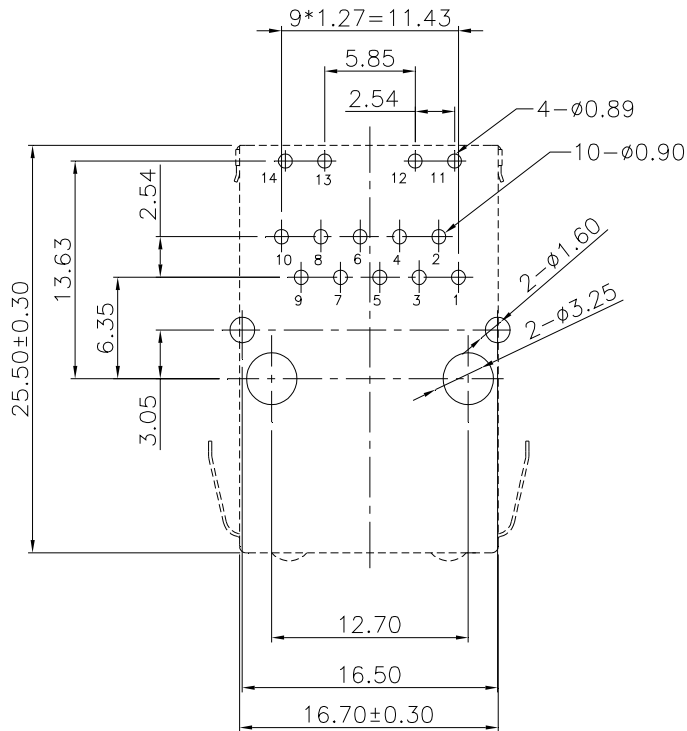

RECOMMENDED PCB LAYOUT
COMPONENT SIDE
ALL DIMENSION TOLERANCE ARE ± 0.05 mm

SUYIN CORPORATION

SPECIFICATION

DOCUMENT NO.: 101111FHAVPM406ZA SUYIN P/N. : 101111FHAVPM406ZA CUSTOMER P/N. :	DESC. : RJ45 1X1 TAB UP W/LED & TRANSFORMER
--	--

3 RECOMMEND RJ PLUG SPECIFICATION

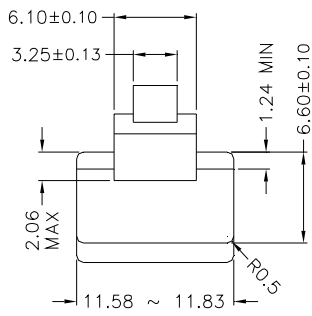

- * There must be no damage to housing or locking latch. There must be no nicks or cuts in cable.
- * Durability : 750 cycles generally

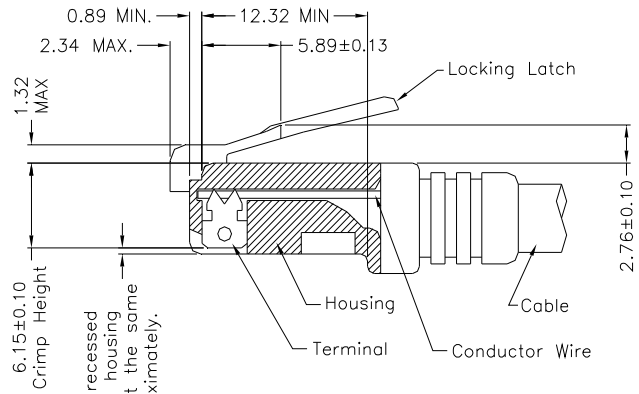

All contacts recessed below top of housing and must be at the same height approximately.

FOLLOW SPECIFICATION : FCC, PART 68, SUBPART F FIGURE 68.500 (C)(2)(i) AND IEC 603-7 FIGURE 23 & 24

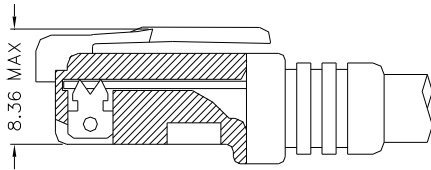

FOLLOW SPECIFICATION : FCC, PART 68, SUBPART F FIGURE 68.500 (C)(2)(ii)

SUYIN CORPORATION

SPECIFICATION

DOCUMENT NO.: 101111FHAVPM406ZA
SUYIN P/N. : 101111FHAVPM406ZA
CUSTOMER P/N.:

DESC. : RJ45 1X1 TAB UP W/LED &
TRANSFORMER

4 MATERIAL SPECIFICATION

4-1 RoHS Compliance per EU Directive 2002/95/EC

4-2 Plastic Housings:

- A. Main Housings: Nylon 9T , UL 94V-0, Black
- B. Transformer Housing: Nylon 9T, UL94V-0, Black
- C. Spacer: PBT, UL94V-0, Black

4-3 Terminals:

- A. RJ Contacts: Phosphor Bronze
- B. RJ Solder Pins: Brass
- C. LED Solder Pins: Brass
- D. Transformer Housing Solder Pins: Brass

4-4 Shields:

- A. Shield: Stainless Steel

4-5 Plating:

- A. RJ Contacts: As P/N specified
- B. RJ Solder Pins: 100u" min. Matte Tin over 50u" Nickel under-plating
- C. LED Solder Pins: 100u" min. Tin over 50u" Nickel under-plating
- D. Transformer Housing Solder Pins: 100u" min. Matte Tin over 50u" Nickel under-plating
- E. Shield Grounding Legs: Pre-soldering, Sn/ Ag/ Cu (96.5/ 3/ 0.5)

4-6 PCB: FR-4, Two Layer PCB

4-7 Internal Solder Joints: Sn/ Ag/ Cu (96.5/ 3/ 0.5)

SUYIN CORPORATION

SPECIFICATION

DOCUMENT NO.: 101111FHAVPM406ZA SUYIN P/N. : 101111FHAVPM406ZA CUSTOMER P/N. :	DESC. : RJ45 1X1 TAB UP W/LED & TRANSFORMER
--	--

5 ELECTRICAL CHARACTERISTICS

5-1 Schematic

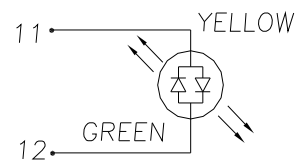
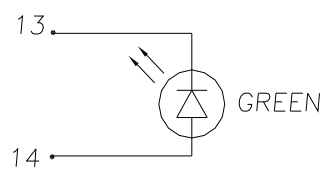
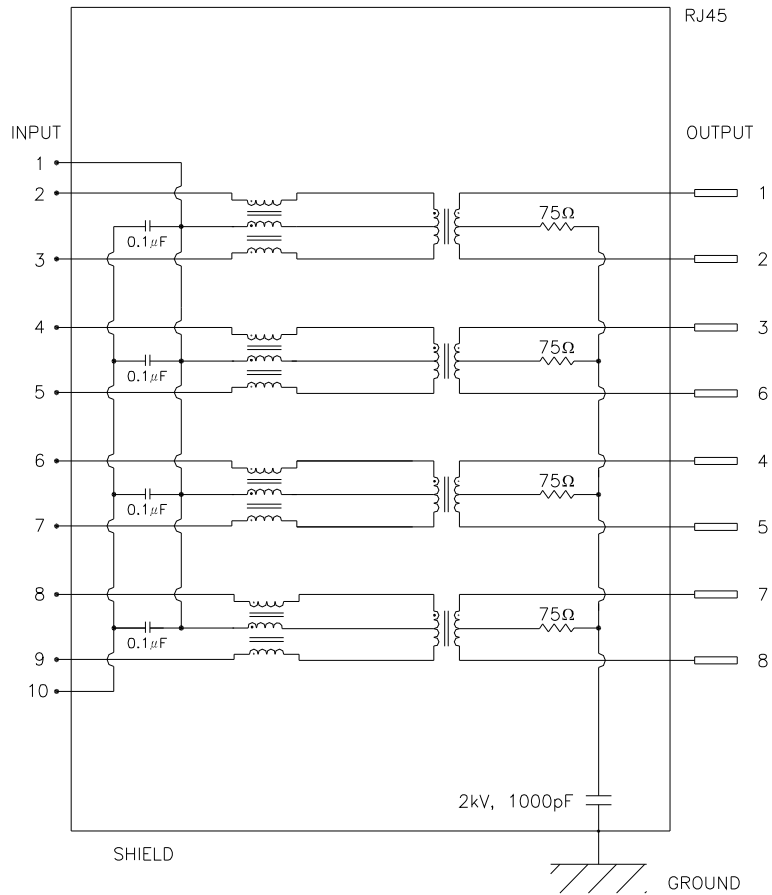

SUYIN CORPORATION

SPECIFICATION

DOCUMENT NO.: 101111FHAVPM406ZA SUYIN P/N. : 101111FHAVPM406ZA CUSTOMER P/N. :	DESC. : RJ45 1X1 TAB UP W/LED & TRANSFORMER
--	--

5-2 Transmitter & Receiver Filter:

Insertion Loss (dB MAX)	Return Loss at 100Ω (dB MIN)			
1~125MHz	1~30MHz	30~60MHz	60~80MHz	80~100MHz
-1.2	-18	-16	-12	-10

5-3 Common Mode Rejection @ 1~100 MHz: -30dB MIN

5-4 Cross Talk @ 1~100 MHz: -25dB MIN

5-5 Inductance @ 100KHz/ 0.1V, 8mA DC BIAS: 350μH MIN

5-6 HiPot Test: 1500Vrms, 60sec

5-7 LED:

Forward Voltage (V) @ 20mA	
Typical	MAX
2.2	2.6

6 OPERATING & TEST REQUIRMENTS

Product is designed to meet electrical, mechanical and environmental performance requirements specified below. All tests are performed at ambient environmental conditions per MIL-STD-1344A and EIA-364 unless otherwise specified

6-1 Operating Temperature Range: 0°C TO +70°C

6-2 Storage Temperature: -40°C to 85°C

6-3 Ratings:

1. Insulation Resistance: 500M Ohm (MIN)
2. Dielectric Withstanding Voltage: 1000 VAC

SUYIN CORPORATION

SPECIFICATION

DOCUMENT NO.: 101111FHAVPM406ZA SUYIN P/N. : 101111FHAVPM406ZA CUSTOMER P/N. :	DESC. : RJ45 1X1 TAB UP W/LED & TRANSFORMER
--	--

7 STORAGE REQUIRMENTS

All products shall be packaged against any physical damage and corrosion during shipment or in storage.

8 RECOMMEND WAVE SOLDERING PROFILE

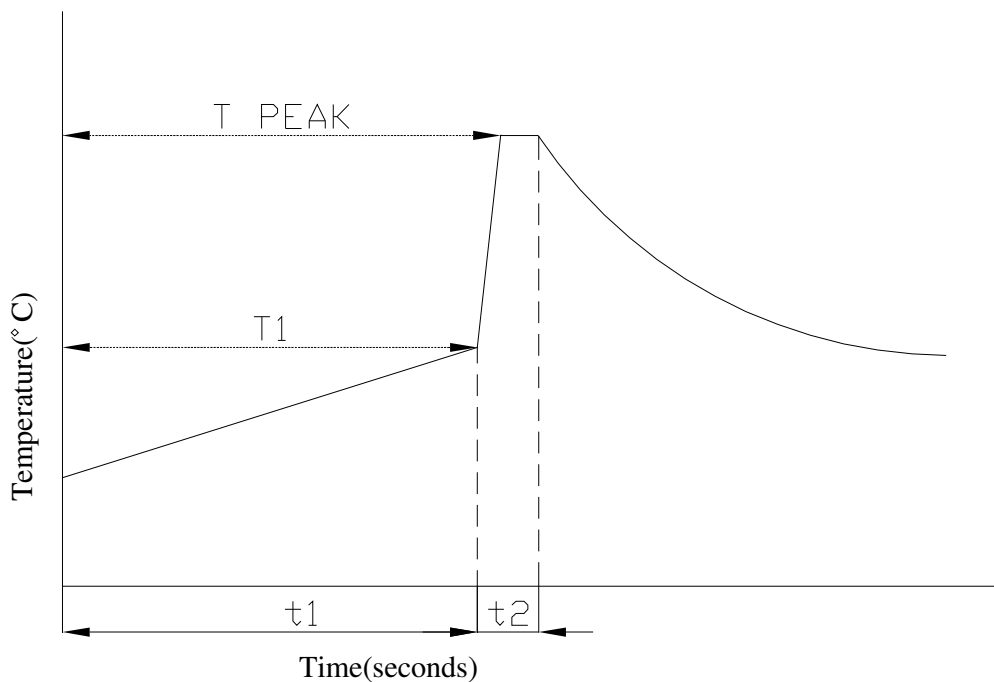

PARAMETER	REFERENCE	LEAD FREE SPECIFICATION
PREHEAT TEMPERATURE GRADIENT		+1~4°C/sec
PREHEAT TIME	t_1	2~3 MIN
PREHEAT TEMPERATURE	T_1	>100°C
SOLDER POT TEMPERATURE	T PEAK	260°C ±5°C
DWELL TIME	t_2	3.5 SEC
PEAK BOARD TOP TEMPERATURE		190°C
COOLING TEMPERATURE GRADIENT		-6°C/SEC MAX.