

SMD Power Inductor CDH36D07



■ Features

- ◎ High operating frequency: up to 5MHz
- ◎ Super low profile inductor: Height:0.85mm Max.
- ◎ Operating temperature range: -40°C~+85°C.
- ◎ RoHS and Halogen-Free Compliance.



■ Applications

Low profile, surface mount inductor for MP3/MP4, Mobile phone and LED driver.

■ Shapes and Dimensions/Recommended Land Patterns(mm)

◆ Dimensions

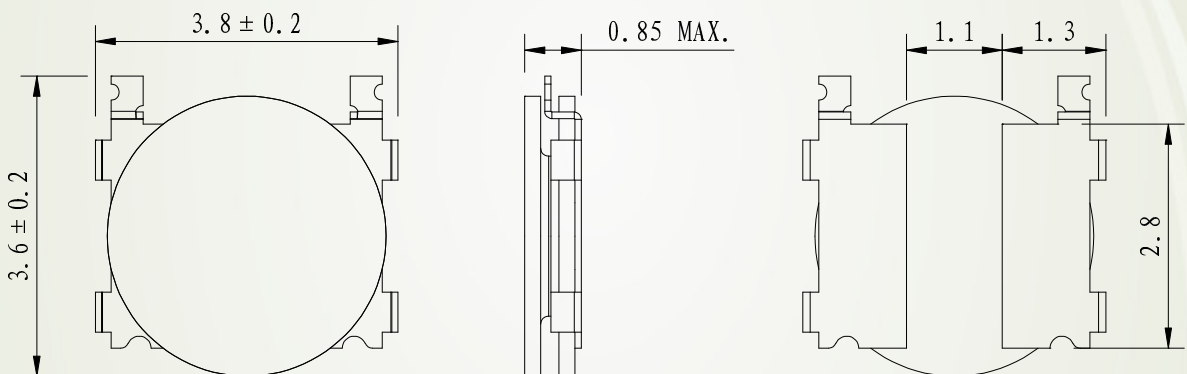

◆ Land pattern (mm)

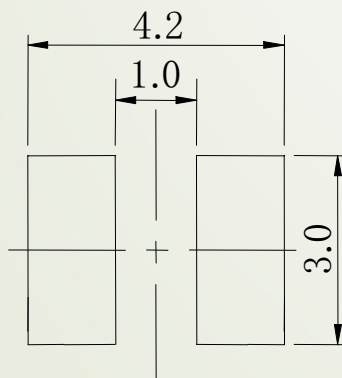

◆ Schematics (Bottom)

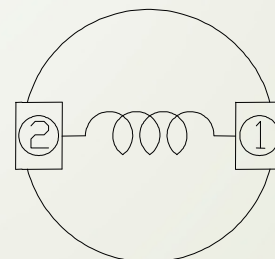

SMD Power Inductor CDH36D07



Electrical Characteristics specification.

Part Name	Stamp	Inductance (μH) 100KHz	D.C.R.(Ω) Max.(Typ.) (at 20°C)	Saturation Current (A) ※1	Temperature Rise Current (A) ※2
CDH36D07NP-1R0NC	1R0	1.0 \pm 30%	0.14 (0.11)	1.79	1.21
CDH36D07NP-1R5NC	1R5	1.5 \pm 30%	0.18 (0.14)	1.52	1.08
CDH36D07NP-2R2MC	2R2	2.2 \pm 20%	0.23 (0.18)	1.24	0.93
CDH36D07NP-2R7MC	2R7	2.7 \pm 20%	0.26 (0.21)	1.12	0.89
CDH36D07NP-3R3MC	3R3	3.3 \pm 20%	0.30 (0.24)	0.98	0.82
CDH36D07NP-4R7MC	4R7	4.7 \pm 20%	0.39 (0.31)	0.90	0.70
CDH36D07NP-6R8MC	6R8	6.8 \pm 20%	0.55 (0.44)	0.70	0.63
CDH36D07NP-8R2MC	8R2	8.2 \pm 20%	0.83 (0.66)	0.65	0.49
CDH36D07NP-100MC	100	10.0 \pm 20%	0.96 (0.77)	0.58	0.36

※1. Saturation Current: The DC current at which the inductance decreases to 70% of its nominal value.

※2. Temperature rise current: The DC current at which the temperature rise is $\Delta t=40^\circ\text{C}$. ($T_a=20^\circ\text{C}$)

Saturation & Temperature Rise Current Characteristics Curve.

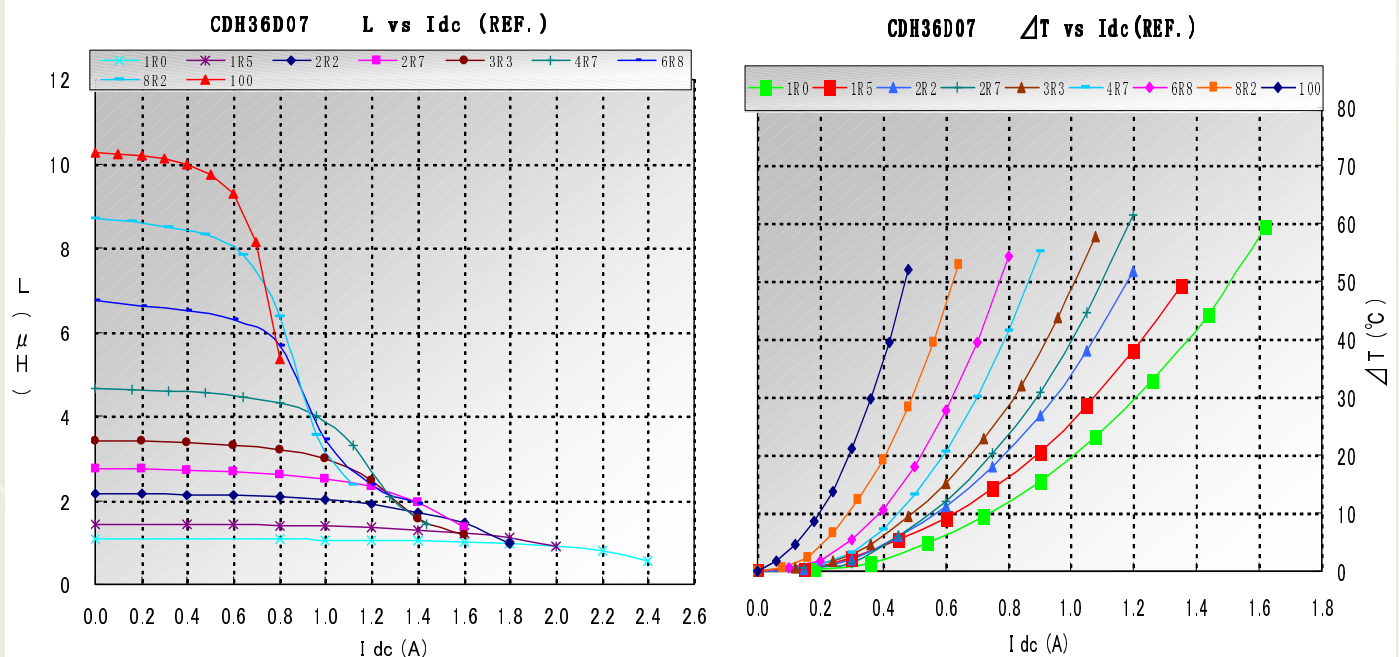

SMD Power Inductor CDH36D07



Recommended Reflow Condition.

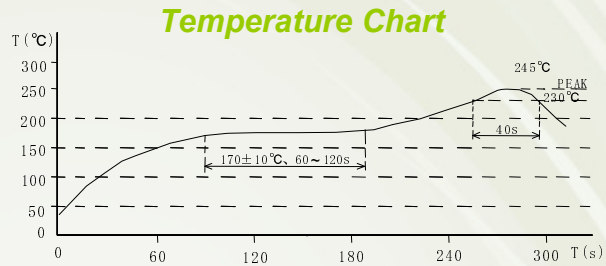
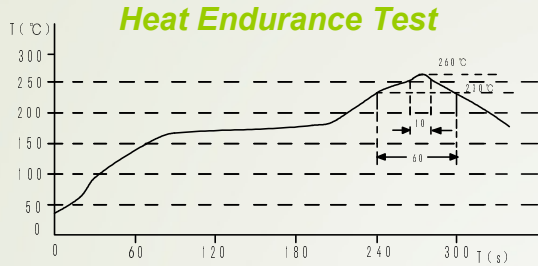

Packaging with Embossed tape and reel.

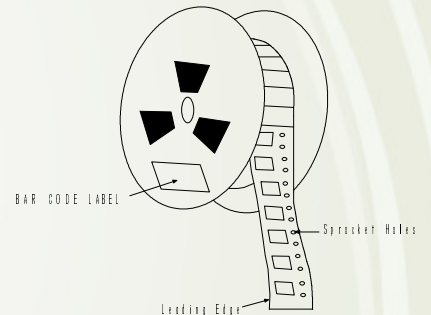
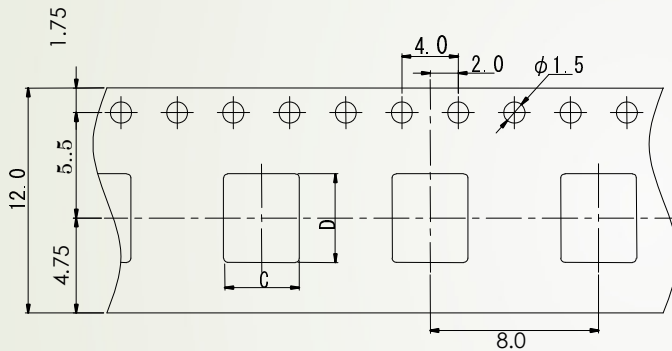

※ Packaging spec. refer to S-074-5282

For More Information

Hong Kong

Tel.+852-2880-6688
FAX.+852-2565-9600

Tokyo

Tel.+81-3-5202-7112
FAX.+81-3-5202-7105

Chicago

Tel.+1-847-545-6700
FAX. +1-847-545-6720

Shanghai

Tel.+86-021-58363299
FAX.+86-021-58363266

Seoul

Tel.+82-2-6237-0777
FAX.+82-2-6237-0778

California

Tel.+1-408-321-9660
FAX. +1-408-321-9308

Shenzhen

Tel.+86-755-82910228
FAX.+86-755-82910338

Singapore

Tel.+65-6296-3388
FAX.+65-6296-3390

Taipei

Tel.+886-2-27065228
FAX.+886-2-27065229

Malaysia

Tel.+60-3-8733-0900
FAX.+60-3-8737-7384