

FEATURES

- 4-Channel Simultaneous Sampling ADC
- 71dB SNR
- 90dB SFDR
- Low Power: 306mW/198mW/160mW Total, 77mW/50mW/40mW per Channel
- Single 1.8V Supply
- Serial LVDS Outputs: One or Two Bits per Channel
- Selectable Input Ranges: 1V_{P-P} to 2V_{P-P}
- 800MHz Full Power Bandwidth Sample-and-Hold
- Shutdown and Nap Modes
- Serial SPI Port for Configuration
- Pin-Compatible 14-Bit and 12-Bit Versions
- 52-Pin (7mm × 8mm) QFN Package

APPLICATIONS

- Communications
- Cellular Base Stations
- Software Defined Radios
- Portable Medical Imaging
- Multichannel Data Acquisition
- Nondestructive Testing

LT, LT, LTC, LTM, Linear Technology and the Linear logo are registered trademarks of Linear Technology Corporation. All other trademarks are the property of their respective owners.

DESCRIPTION

The LTC[®]2172-12/LTC2171-12/LTC2170-12 are 4-channel, simultaneous sampling 12-bit A/D converters designed for digitizing high frequency, wide dynamic range signals. They are perfect for demanding communications applications with AC performance that includes 71dB SNR and 90dB spurious free dynamic range (SFDR). An ultralow jitter of 0.15ps_{RMS} allows undersampling of IF frequencies with excellent noise performance.

DC specifications include ±0.3LSB INL (typ), ±0.1LSB DNL (typ) and no missing codes over temperature. The transition noise is a low 0.3LSB_{RMS}.

The digital outputs are serial LVDS to minimize the number of data lines. Each channel outputs two bits at a time (2-lane mode) or one bit at a time (1-lane mode). The LVDS drivers have optional internal termination and adjustable output levels to ensure clean signal integrity.

The ENC⁺ and ENC⁻ inputs may be driven differentially or single-ended with a sine wave, PECL, LVDS, TTL or CMOS inputs. An internal clock duty cycle stabilizer allows high performance at full speed for a wide range of clock duty cycles.

TYPICAL APPLICATION

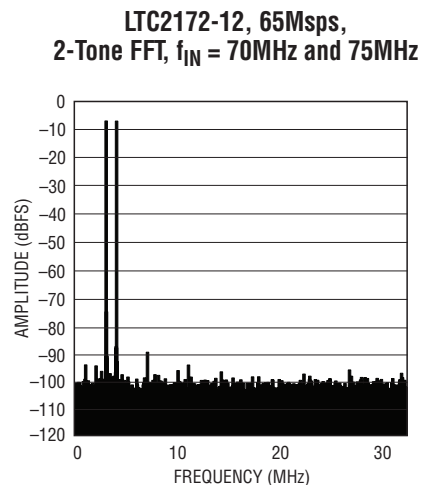
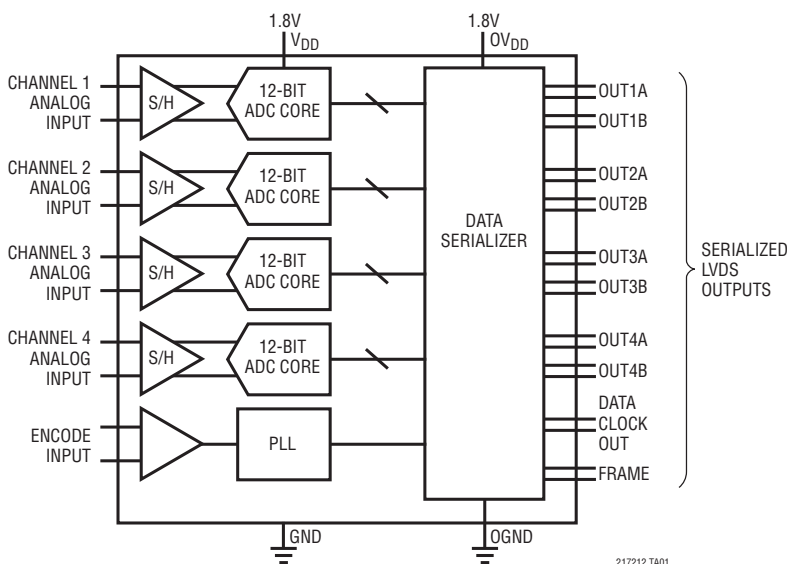

LTC2172-12/ LTC2171-12/LTC2170-12

ABSOLUTE MAXIMUM RATINGS

(Notes 1 and 2)

Supply Voltages

V_{DD} , OV_{DD} -0.3V to 2V

Analog Input Voltage (A_{IN}^+ , A_{IN}^- ,
PAR/SER, SENSE) (Note 3)..... -0.3V to ($V_{DD} + 0.2V$)

Digital Input Voltage (ENC^+ , ENC^- , \overline{CS} ,
SDI, SCK) (Note 4)..... -0.3V to 3.9V

SDO (Note 4) -0.3V to 3.9V

Digital Output Voltage -0.3V to ($OV_{DD} + 0.3V$)

Operating Temperature Range

LTC2172C, LTC2171C, LTC2170C..... 0°C to 70°C

LTC2172I, LTC2171I, LTC2170I..... -40°C to 85°C

Storage Temperature Range..... -65°C to 150°C

PIN CONFIGURATION

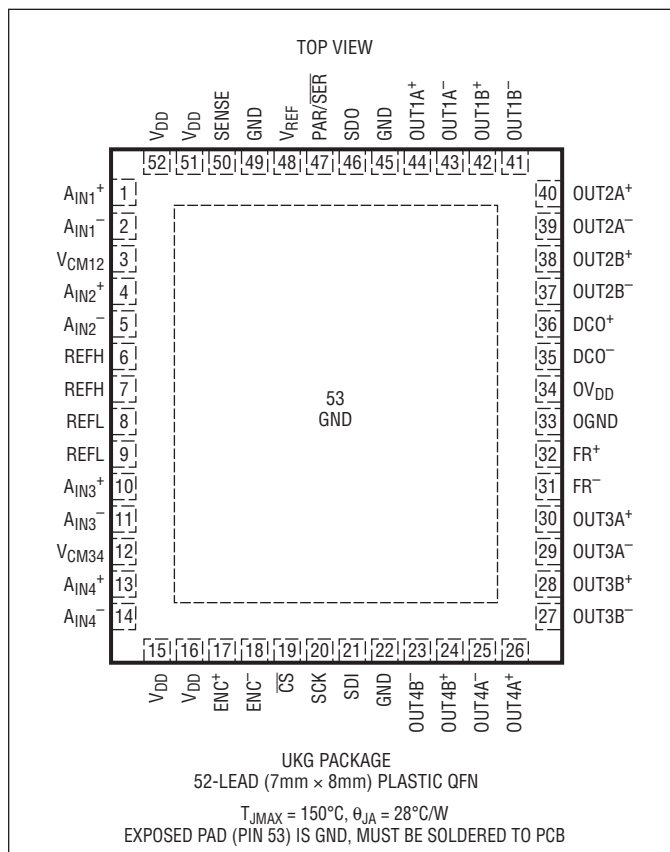

ORDER INFORMATION

LEAD FREE FINISH	TAPE AND REEL	PART MARKING*	PACKAGE DESCRIPTION	TEMPERATURE RANGE
LTC2172CUKG-12#PBF	LTC2172CUKG-12#TRPBF	LTC2172UKG-12	52-Lead (7mm × 8mm) Plastic QFN	0°C to 70°C
LTC2172IUKG-12#PBF	LTC2172IUKG-12#TRPBF	LTC2172UKG-12	52-Lead (7mm × 8mm) Plastic QFN	-40°C to 85°C
LTC2171CUKG-12#PBF	LTC2171CUKG-12#TRPBF	LTC2171UKG-12	52-Lead (7mm × 8mm) Plastic QFN	0°C to 70°C
LTC2171IUKG-12#PBF	LTC2171IUKG-12#TRPBF	LTC2171UKG-12	52-Lead (7mm × 8mm) Plastic QFN	-40°C to 85°C
LTC2170CUKG-12#PBF	LTC2170CUKG-12#TRPBF	LTC2170UKG-12	52-Lead (7mm × 8mm) Plastic QFN	0°C to 70°C
LTC2170IUKG-12#PBF	LTC2170IUKG-12#TRPBF	LTC2170UKG-12	52-Lead (7mm × 8mm) Plastic QFN	-40°C to 85°C

Consult LTC Marketing for parts specified with wider operating temperature ranges. *The temperature grade is identified by a label on the shipping container.

For more information on lead free part marking, go to: <http://www.linear.com/leadfree/>

For more information on tape and reel specifications, go to: <http://www.linear.com/tapeandreel/>

CONVERTER CHARACTERISTICS The ● denotes the specifications which apply over the full operating temperature range, otherwise specifications are at $T_A = 25^\circ\text{C}$. (Note 5)

PARAMETER	CONDITIONS	LTC2172-12			LTC2171-12			LTC2170-12			UNITS	
		MIN	TYP	MAX	MIN	TYP	MAX	MIN	TYP	MAX		
Resolution (No Missing Codes)		●	12		12		12		12		Bits	
Integral Linearity Error	Differential Analog Input (Note 6)	●	-1	±0.3	1	-1	±0.3	1	-1	±0.3	1	LSB
Differential Linearity Error	Differential Analog Input	●	-0.5	±0.1	0.5	-0.4	±0.1	0.4	-0.4	±0.1	0.4	LSB
Offset Error	(Note 7)	●	-12	±3	12	-12	±3	12	-12	±3	12	mV
Gain Error	Internal Reference External Reference	●	-2.5	-1	0.5	-2.5	-1	0.5	-2.5	-1	0.5	%FS %FS
Offset Drift			±20		±20		±20		±20		μV/°C	
Full-Scale Drift	Internal Reference External Reference		±35 ±25		±35 ±25		±35 ±25		±35 ±25		ppm/°C ppm/°C	
Gain Matching	External Reference		±0.2		±0.2		±0.2		±0.2		%FS	
Offset Matching			±3		±3		±3		±3		mV	
Transition Noise	External Reference		0.32		0.32		0.32		0.32		LSB _{RMS}	

ANALOG INPUT The ● denotes the specifications which apply over the full operating temperature range, otherwise specifications are at $T_A = 25^\circ\text{C}$. (Note 5)

SYMBOL	PARAMETER	CONDITIONS	MIN	TYP	MAX	UNITS
V_{IN}	Analog Input Range ($A_{IN}^+ - A_{IN}^-$)	$1.7V < V_{DD} < 1.9V$	●	1 to 2		V_{P-P}
$V_{IN(CM)}$	Analog Input Common Mode ($(A_{IN}^+ + A_{IN}^-)/2$)	Differential Analog Input (Note 8)	●	$V_{CM} - 100\text{mV}$	V_{CM} $V_{CM} + 100\text{mV}$	V
V_{SENSE}	External Voltage Reference Applied to SENSE	External Reference Mode	●	0.625	1.250 1.300	V
$I_{IN(CM)}$	Analog Input Common Mode Current	Per Pin, 65Msps Per Pin, 40Msps Per Pin, 25Msps		81 50 31		μA μA μA
I_{IN1}	Analog Input Leakage Current (No Encode)	$0 < A_{IN}^+, A_{IN}^- < V_{DD}$	●	-1	1	μA
I_{IN2}	PAR/SER Input Leakage Current	$0 < \text{PAR/SER} < V_{DD}$	●	-3	3	μA
I_{IN3}	SENSE Input Leakage Current	$0.625 < \text{SENSE} < 1.3V$	●	-6	6	μA
t_{AP}	Sample-and-Hold Acquisition Delay Time			0		ns
t_{JITTER}	Sample-and-Hold Acquisition Delay Jitter			0.15		ps _{RMS}
CMRR	Analog Input Common Mode Rejection Ratio			80		dB
BW-3B	Full-Power Bandwidth	Figure 6 Test Circuit		800		MHz

LTC2172-12/ LTC2171-12/LTC2170-12

DYNAMIC ACCURACY The ● denotes the specifications which apply over the full operating temperature range, otherwise specifications are at $T_A = 25^\circ\text{C}$. $A_{IN} = -1\text{dBFS}$. (Note 5)

SYMBOL	PARAMETER	CONDITIONS	LTC2172-12			LTC2171-12			LTC2170-12			UNITS
			MIN	TYP	MAX	MIN	TYP	MAX	MIN	TYP	MAX	
SNR	Signal-to-Noise Ratio	5MHz Input	● 69.7	71	69.5	70.9	69.3	70.5	dBFS			
		30MHz Input		71		70.8		70.5				
		70MHz Input		70.9		70.8		70.5				
		140MHz Input		70.6		70.5		70.2				
SFDR	Spurious Free Dynamic Range 2nd or 3rd Harmonic	5MHz Input	● 77	90	79	90	79	90	dBFS			
		30MHz Input		90		90		90				
		70MHz Input		89		89		89				
	Spurious Free Dynamic Range 4th Harmonic or Higher	5MHz Input	● 85	90	85	90	85	90	dBFS			
		30MHz Input		90		90		90				
		70MHz Input		90		90		90				
S/(N+D)	Signal-to-Noise Plus Distortion Ratio	5MHz Input	● 69.1	70.9	69.4	70.8	69.2	70.5	dBFS			
		30MHz Input		70.9		70.7		70.4				
		70MHz Input		70.7		70.6		70.3				
		140MHz Input		70.3		70.2		69.9				
	Crosstalk, Near Channel	10MHz Input (Note 12)		-90		-90		-90	dBc			
	Crosstalk, Far Channel	10MHz Input (Note 12)		-105		-105		-105	dBc			

INTERNAL REFERENCE CHARACTERISTICS The ● denotes the specifications which apply over the full operating temperature range, otherwise specifications are at $T_A = 25^\circ\text{C}$. $A_{IN} = -1\text{dBFS}$. (Note 5)

PARAMETER	CONDITIONS	MIN	TYP	MAX	UNITS
V_{CM} Output Voltage	$I_{OUT} = 0$	$0.5 \cdot V_{DD} - 25\text{mV}$	$0.5 \cdot V_{DD}$	$0.5 \cdot V_{DD} + 25\text{mV}$	V
V_{CM} Output Temperature Drift			± 25		ppm/ $^\circ\text{C}$
V_{CM} Output Resistance	$-600\mu\text{A} < I_{OUT} < 1\text{mA}$		4		Ω
V_{REF} Output Voltage	$I_{OUT} = 0$	1.225	1.250	1.275	V
V_{REF} Output Temperature Drift			± 25		ppm/ $^\circ\text{C}$
V_{REF} Output Resistance	$-400\mu\text{A} < I_{OUT} < 1\text{mA}$		7		Ω
V_{REF} Line Regulation	$1.7\text{V} < V_{DD} < 1.9\text{V}$		0.6		mV/V

DIGITAL INPUTS AND OUTPUTS The ● denotes the specifications which apply over the full operating temperature range, otherwise specifications are at $T_A = 25^\circ\text{C}$. (Note 5)

SYMBOL	PARAMETER	CONDITIONS		MIN	TYP	MAX	UNITS
ENCODE INPUTS (ENC⁺, ENC⁻)							
Differential Encode Mode (ENC⁻ Not Tied to GND)							
V _{ID}	Differential Input Voltage	(Note 8)	●	0.2			V
V _{ICM}	Common Mode Input Voltage	Internally Set Externally Set (Note 8)	●	1.1	1.2	1.6	V V
V _{IN}	Input Voltage Range	ENC ⁺ , ENC ⁻ to GND	●	0.2		3.6	V
R _{IN}	Input Resistance	(See Figure 10)			10		kΩ
C _{IN}	Input Capacitance				3.5		pF
Single-Ended Encode Mode (ENC⁻ Tied to GND)							
V _{IH}	High Level Input Voltage	V _{DD} = 1.8V	●	1.2			V
V _{IL}	Low Level Input Voltage	V _{DD} = 1.8V	●			0.6	V
V _{IN}	Input Voltage Range	ENC ⁺ to GND	●	0		3.6	V
R _{IN}	Input Resistance	(See Figure 11)			30		kΩ
C _{IN}	Input Capacitance				3.5		pF
DIGITAL INPUTS (CS, SDI, SCK in Serial or Parallel Programming Mode. SDO in Parallel Programming Mode)							
V _{IH}	High Level Input Voltage	V _{DD} = 1.8V	●	1.3			V
V _{IL}	Low Level Input Voltage	V _{DD} = 1.8V	●			0.6	V
I _{IN}	Input Current	V _{IN} = 0V to 3.6V	●	-10		10	μA
C _{IN}	Input Capacitance				3		pF
SDO OUTPUT (Serial Programming Mode. Open-Drain Output. Requires 2k Pull-Up Resistor if SDO Is Used)							
R _{OL}	Logic Low Output Resistance to GND	V _{DD} = 1.8V, SDO = 0V			200		Ω
I _{OH}	Logic High Output Leakage Current	SDO = 0V to 3.6V	●	-10		10	μA
C _{OUT}	Output Capacitance				3		pF
DIGITAL DATA OUTPUTS							
V _{OD}	Differential Output Voltage	100Ω Differential Load, 3.5mA Mode 100Ω Differential Load, 1.75mA Mode	● ●	247 125	350 175	454 250	mV mV
V _{OS}	Common Mode Output Voltage	100Ω Differential Load, 3.5mA Mode 100Ω Differential Load, 1.75mA Mode	● ●	1.125 1.125	1.250 1.250	1.375 1.375	V V
R _{TERM}	On-Chip Termination Resistance	Termination Enabled, 0V _{DD} = 1.8V			100		Ω

LTC2172-12/ LTC2171-12/LTC2170-12

POWER REQUIREMENTS

The ● denotes the specifications which apply over the full operating temperature range, otherwise specifications are at $T_A = 25^\circ\text{C}$. (Note 9)

SYMBOL	PARAMETER	CONDITIONS		LTC2172-12			LTC2171-12			LTC2170-12			UNITS
				MIN	TYP	MAX	MIN	TYP	MAX	MIN	TYP	MAX	
V_{DD}	Analog Supply Voltage	(Note 10)	●	1.7	1.8	1.9	1.7	1.8	1.9	1.7	1.8	1.9	V
OV_{DD}	Output Supply Voltage	(Note 10)	●	1.7	1.8	1.9	1.7	1.8	1.9	1.7	1.8	1.9	V
I_{VDD}	Analog Supply Current	Sine Wave Input	●		154	177		94	111		74	83	mA
I_{OVDD}	Digital Supply Current	1-Lane Mode, 1.75mA Mode			16			16			15		mA
		1-Lane Mode, 3.5mA Mode			30			29			28		mA
		2-Lane Mode, 1.75mA Mode	●		25	28		24	27		24	26	mA
		2-Lane Mode, 3.5mA Mode	●		47	50		46	50		45	49	mA
P_{DISS}	Power Dissipation	1-Lane Mode, 1.75mA Mode			306			198			160		mW
		1-Lane Mode, 3.5mA Mode			331			221			184		mW
		2-Lane Mode, 1.75mA Mode	●		322	369		212	248		176	196	mW
		2-Lane Mode, 3.5mA Mode	●		362	409		252	290		214	238	mW
P_{SLEEP}	Sleep Mode Power			1			1			1		mW	
P_{NAP}	Nap Mode Power			75			75			75		mW	
$P_{DIFFCLK}$	Power Increase with Differential Encode Mode Enabled (No Increase for Sleep Mode)			20			20			20		mW	

TIMING CHARACTERISTICS

The ● denotes the specifications which apply over the full operating temperature range, otherwise specifications are at $T_A = 25^\circ\text{C}$. (Note 5)

SYMBOL	PARAMETER	CONDITIONS		LTC2172-12			LTC2171-12			LTC2170-12			UNITS
				MIN	TYP	MAX	MIN	TYP	MAX	MIN	TYP	MAX	
f_S	Sampling Frequency	(Notes 10, 11)	●	5		65	5		40	5		25	MHz
t_{ENCL}	ENC Low Time (Note 8)	Duty Cycle Stabilizer Off	●	7.3	7.69	100	11.88	12.5	100	19	20	100	ns
		Duty Cycle Stabilizer On	●	2	7.69	100	2	12.5	100	2	20	100	ns
t_{ENCH}	ENC High Time (Note 8)	Duty Cycle Stabilizer Off	●	7.3	7.69	100	11.88	12.5	100	19	20	100	ns
		Duty Cycle Stabilizer On	●	2	7.69	100	2	12.5	100	2	20	100	ns
t_{AP}	Sample-and-Hold Acquisition Delay Time			0			0			0		ns	

TIMING CHARACTERISTICS The ● denotes the specifications which apply over the full operating temperature range, otherwise specifications are at $T_A = 25^\circ\text{C}$. (Note 5)

SYMBOL	PARAMETER	CONDITIONS	MIN	TYP	MAX	UNITS
Digital Data Outputs ($R_{\text{TERM}} = 100\Omega$ Differential, $C_L = 2\text{pF}$ to GND on Each Output)						
t_{SER}	Serial Data Bit Period	2-Lanes, 16-Bit Serialization 2-Lanes, 14-Bit Serialization 2-Lanes, 12-Bit Serialization 1-Lane, 16-Bit Serialization 1-Lane, 14-Bit Serialization 1-Lane, 12-Bit Serialization		$1 / (8 \cdot f_S)$ $1 / (7 \cdot f_S)$ $1 / (6 \cdot f_S)$ $1 / (16 \cdot f_S)$ $1 / (14 \cdot f_S)$ $1 / (12 \cdot f_S)$		s s s s s s
t_{FRAME}	FR to DCO Delay	(Note 8)	●	$0.35 \cdot t_{\text{SER}}$	$0.5 \cdot t_{\text{SER}}$	$0.65 \cdot t_{\text{SER}}$ s
t_{DATA}	DATA to DCO Delay	(Note 8)	●	$0.35 \cdot t_{\text{SER}}$	$0.5 \cdot t_{\text{SER}}$	$0.65 \cdot t_{\text{SER}}$ s
t_{PD}	Propagation Delay	(Note 8)	●	$0.7\text{n} + 2 \cdot t_{\text{SER}}$	$1.1\text{n} + 2 \cdot t_{\text{SER}}$	$1.5\text{n} + 2 \cdot t_{\text{SER}}$ s
t_{R}	Output Rise Time	Data, DCO, FR, 20% to 80%		0.17		ns
t_{F}	Output Fall Time	Data, DCO, FR, 20% to 80%		0.17		ns
	DCO Cycle-to-Cycle Jitter	$t_{\text{SER}} = 1\text{ns}$		60		pSP-P
	Pipeline Latency			6		Cycles
SPI Port Timing (Note 8)						
t_{SCK}	SCK Period	Write Mode Readback Mode, $C_{\text{SDO}} = 20\text{pF}$, $R_{\text{PULLUP}} = 2\text{k}$	● ●	40 250		ns ns
t_{S}	$\overline{\text{CS}}$ to SCK Set-Up Time		●	5		ns
t_{H}	SCK to $\overline{\text{CS}}$ Set-Up Time		●	5		ns
t_{DS}	SDI Set-Up Time		●	5		ns
t_{DH}	SDI Hold Time		●	5		ns
t_{DO}	SCK Falling to SDO Valid	Readback Mode $C_{\text{SDO}} = 20\text{pF}$, $R_{\text{PULLUP}} = 2\text{k}$	●		125	ns

Note 1: Stresses beyond those listed under Absolute Maximum Ratings may cause permanent damage to the device. Exposure to any Absolute Maximum Rating condition for extended periods may affect device reliability and lifetime.

Note 2: All voltage values are with respect to GND with GND and OGND shorted (unless otherwise noted).

Note 3: When these pin voltages are taken below GND or above V_{DD} , they will be clamped by internal diodes. This product can handle input currents of greater than 100mA below GND or above V_{DD} without latchup.

Note 4: When these pin voltages are taken below GND they will be clamped by internal diodes. When these pin voltages are taken above V_{DD} they will not be clamped by internal diodes. This product can handle input currents of greater than 100mA below GND without latchup.

Note 5: $V_{\text{DD}} = \text{OV}_{\text{DD}} = 1.8\text{V}$, $f_{\text{SAMPLE}} = 65\text{MHz}$ (LTC2172), 40MHz (LTC2171), or 25MHz (LTC2170), 2-lane output mode, differential $\text{ENC}^+/\text{ENC}^- = 2V_{\text{P-P}}$ sine wave, input range = $2V_{\text{P-P}}$ with differential drive, unless otherwise noted.

Note 6: Integral nonlinearity is defined as the deviation of a code from a best fit straight line to the transfer curve. The deviation is measured from the center of the quantization band.

Note 7: Offset error is the offset voltage measured from -0.5 LSB when the output code flickers between 0000 0000 0000 and 1111 1111 1111 in 2's complement output mode.

Note 8: Guaranteed by design, not subject to test.

Note 9: $V_{\text{DD}} = \text{OV}_{\text{DD}} = 1.8\text{V}$, $f_{\text{SAMPLE}} = 65\text{MHz}$ (LTC2172), 40MHz (LTC2171), or 25MHz (LTC2170), 2-lane output mode, $\text{ENC}^+ =$ single-ended 1.8V square wave, $\text{ENC}^- = 0\text{V}$, input range = $2V_{\text{P-P}}$ with differential drive, unless otherwise noted. The supply current and power dissipation specifications are totals for the entire chip, not per channel.

Note 10: Recommended operating conditions.

Note 11: The maximum sampling frequency depends on the speed grade of the part and also which serialization mode is used. The maximum serial data rate is 1000Mbps, so t_{SER} must be greater than or equal to 1ns.

Note 12: Near-channel crosstalk refers to Ch. 1 to Ch.2, and Ch.3 to Ch.4. Far-channel crosstalk refers to Ch.1 to Ch.3, Ch.1 to Ch.4, Ch.2 to Ch.3, and Ch.2 to Ch.4.

TIMING DIAGRAMS

2-Lane Output Mode, 16-Bit Serialization

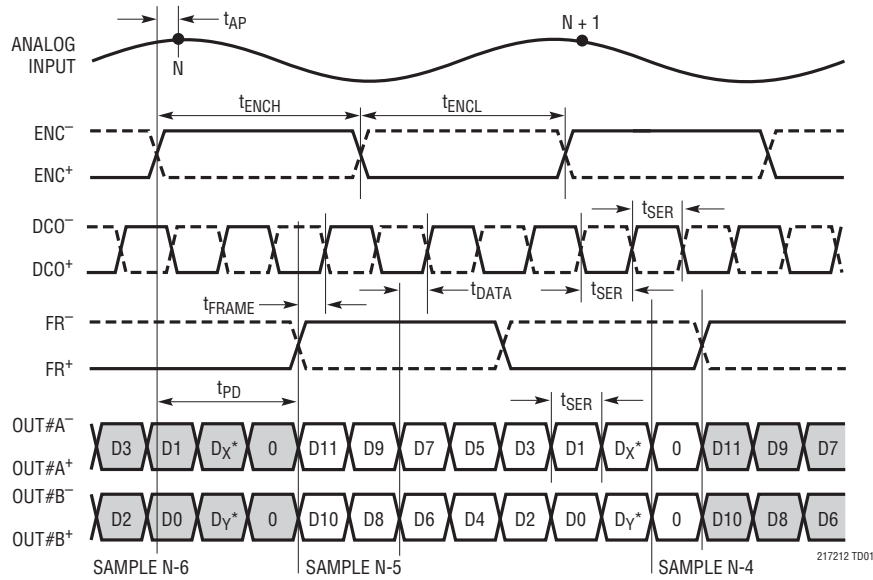

*D_X AND D_Y ARE EXTRA NON-DATA BITS FOR COMPLETE SOFTWARE COMPATIBILITY WITH THE 14-BIT VERSIONS OF THESE A/Ds. DURING NORMAL NON-OVERRANGED OPERATION D_X AND D_Y ARE SET TO LOGIC 0. SEE THE DATA FORMAT SECTION FOR MORE DETAILS.

2-Lane Output Mode, 14-Bit Serialization

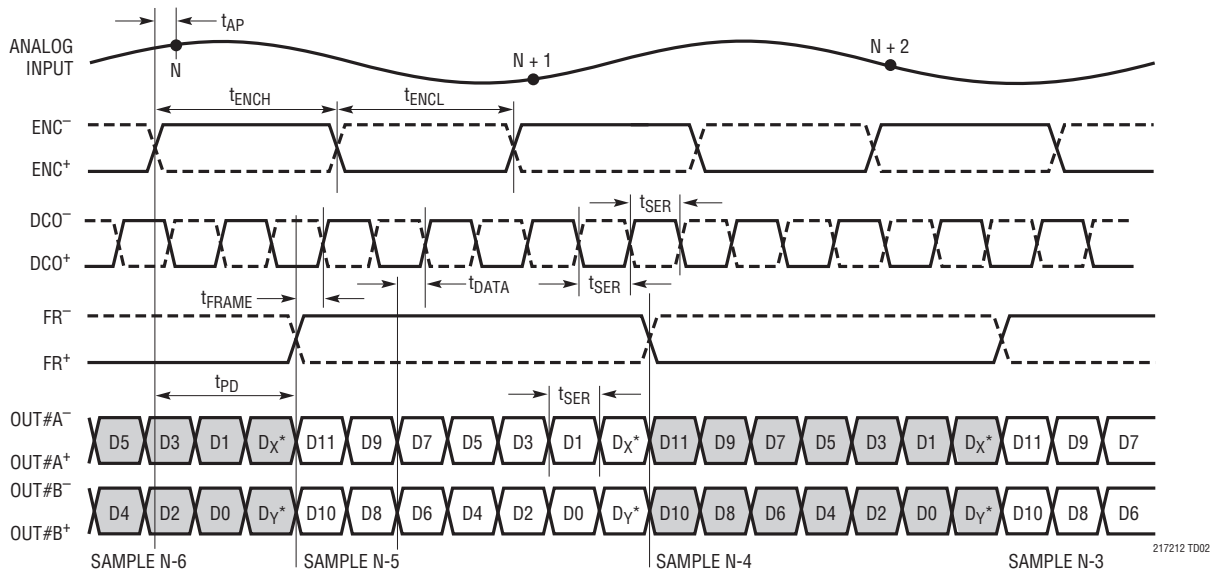

NOTE THAT IN THIS MODE, FR⁺/FR⁻ HAS TWO TIMES THE PERIOD OF ENC⁺/ENC⁻

*D_X AND D_Y ARE EXTRA NON-DATA BITS FOR COMPLETE SOFTWARE COMPATIBILITY WITH THE 14-BIT VERSIONS OF THESE A/Ds. DURING NORMAL NON-OVERRANGED OPERATION D_X AND D_Y ARE SET TO LOGIC 0. SEE THE DATA FORMAT SECTION FOR MORE DETAILS.

TIMING DIAGRAMS

2-Lane Output Mode, 12-Bit Serialization

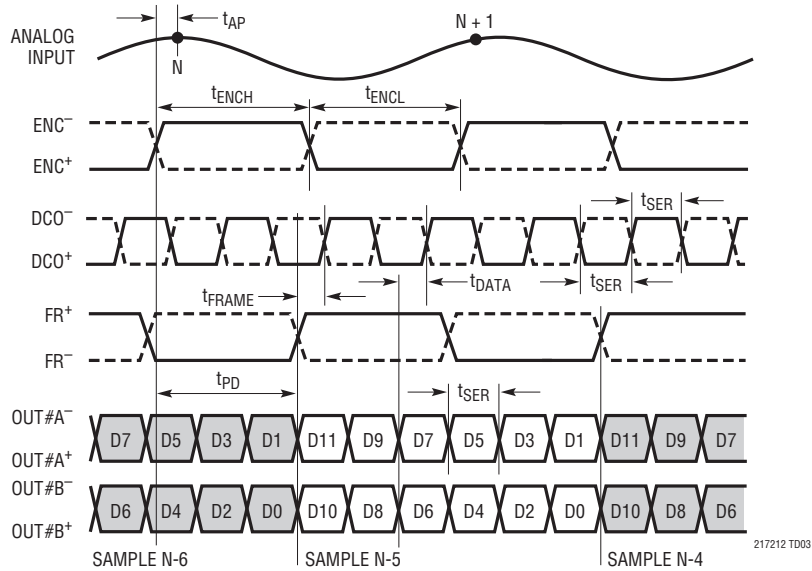

1-Lane Output Mode, 16-Bit Serialization

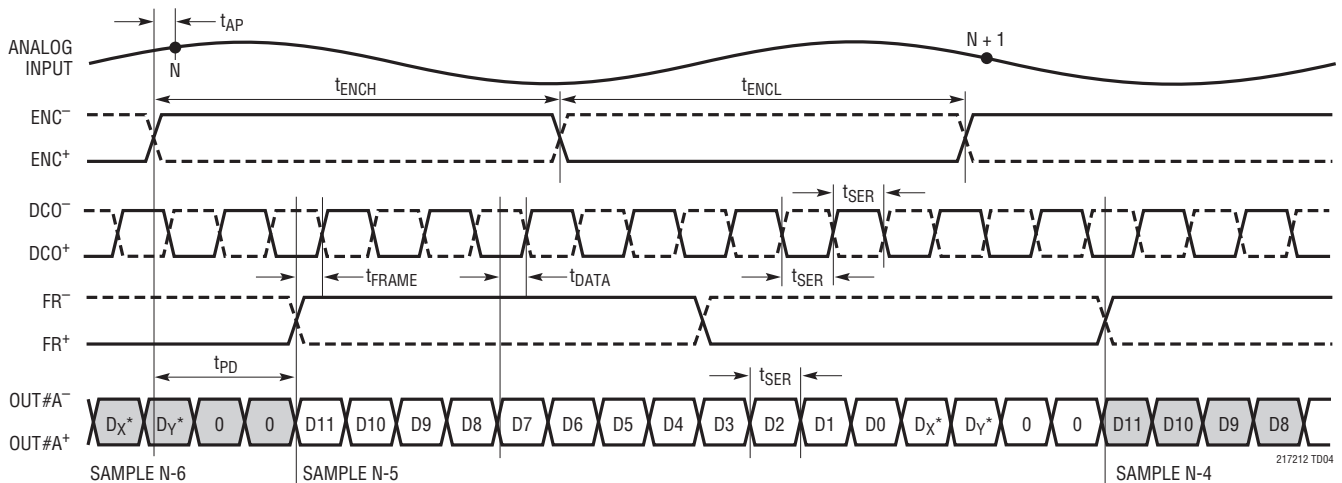

OUT#B⁺, OUT#B⁻ ARE DISABLED

* D_X AND D_Y ARE EXTRA NON-DATA BITS FOR COMPLETE SOFTWARE COMPATIBILITY WITH THE 14-BIT VERSIONS OF THESE A/Ds. DURING NORMAL NON-OVERRANGED OPERATION D_X AND D_Y ARE SET TO LOGIC 0. SEE THE DATA FORMAT SECTION FOR MORE DETAILS.

TIMING DIAGRAMS

1-Lane Output Mode, 14-Bit Serialization

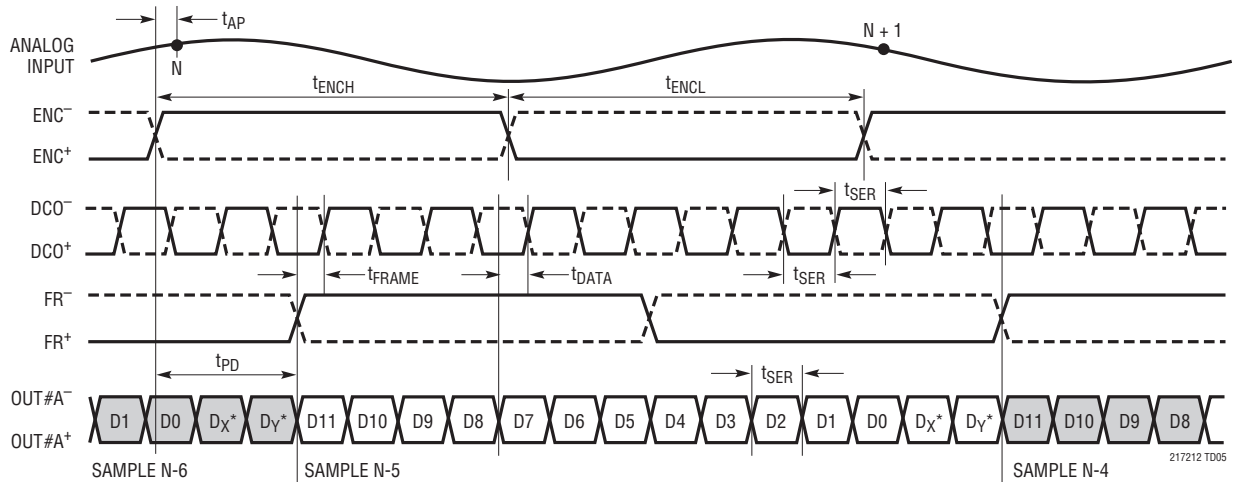

OUT#B⁺, OUT#B⁻ ARE DISABLED

*D_x AND D_y ARE EXTRA NON-DATA BITS FOR COMPLETE SOFTWARE COMPATIBILITY WITH THE 14-BIT VERSIONS OF THESE A/Ds. DURING NORMAL NON-OVERRANGED OPERATION D_x AND D_y ARE SET TO LOGIC 0. SEE THE DATA FORMAT SECTION FOR MORE DETAILS.

1-Lane Output Mode, 12-Bit Serialization

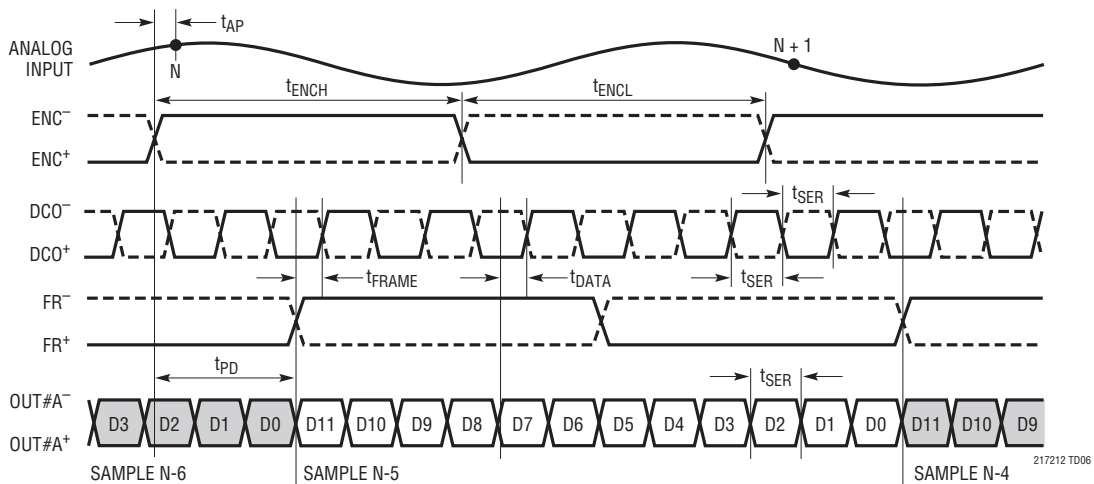

OUT#B⁺, OUT#B⁻ ARE DISABLED

TIMING DIAGRAMS

SPI Port Timing (Readback Mode)

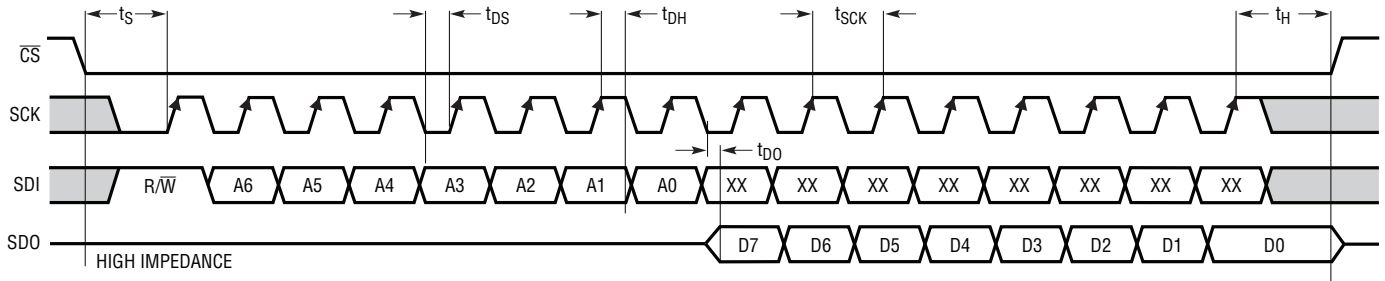

SPI Port Timing (Write Mode)

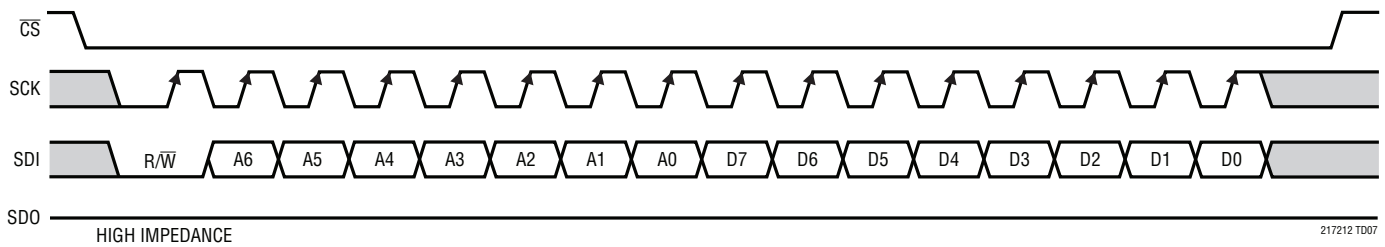

TYPICAL PERFORMANCE CHARACTERISTICS

LTC2172-12: Integral Nonlinearity (INL)

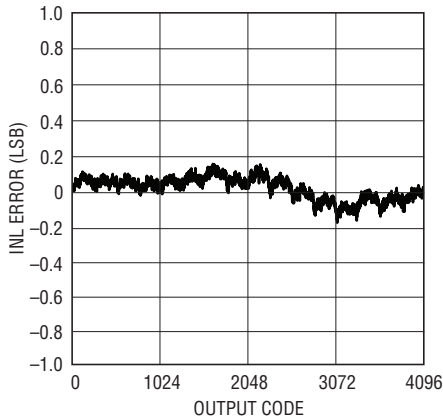

217212 G01

LTC2172-12: Differential Nonlinearity (DNL)

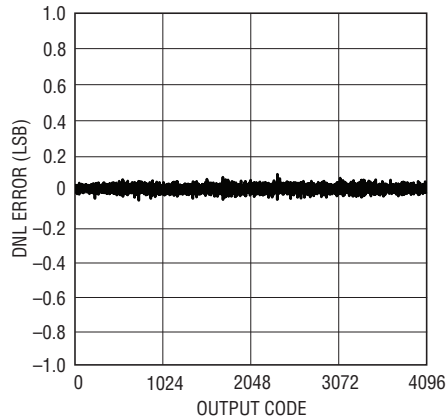

217212 G02

LTC2172-12: 8k Point FFT, $f_{IN} = 5\text{MHz}$, -1dBFS , 65Mpsps

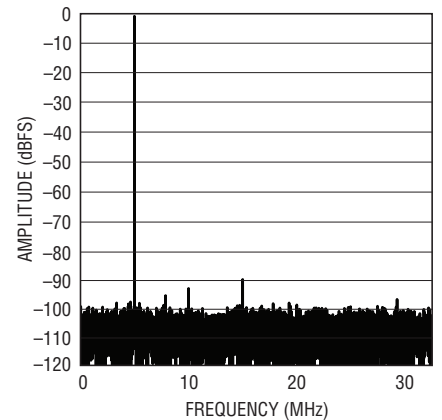

217212 G03

LTC2172-12: 8k Point FFT, $f_{IN} = 30\text{MHz}$, -1dBFS , 65Mpsps

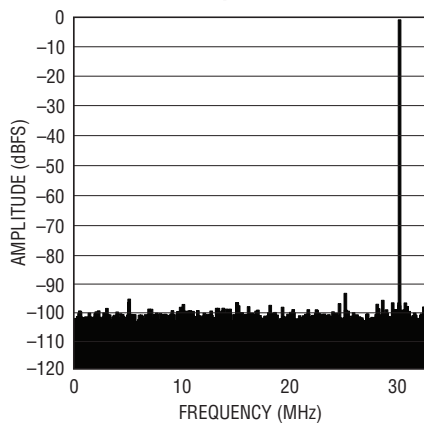

217212 G04

LTC2172-12: 8k Point FFT, $f_{IN} = 70\text{MHz}$, -1dBFS , 65Mpsps

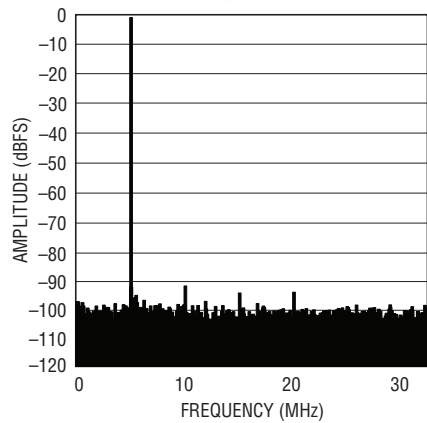

217212 G05

LTC2172-12: 8k Point FFT, $f_{IN} = 140\text{MHz}$, -1dBFS , 65Mpsps

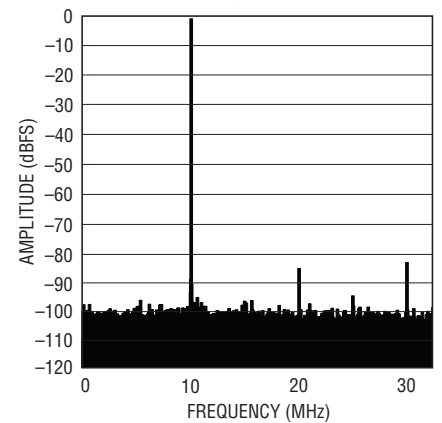

217212 G06

LTC2172-12: 8k Point 2-Tone FFT, $f_{IN} = 68\text{MHz}$, 69MHz , -1dBFS , 65Mpsps

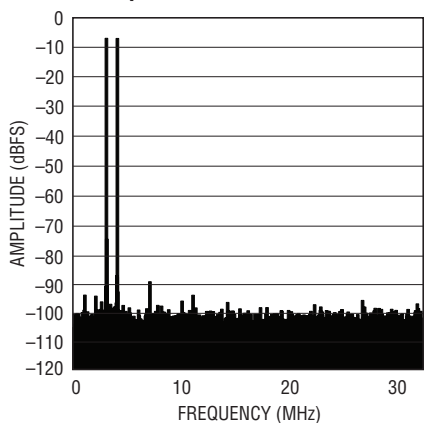

217212 G07

LTC2172-12: Shorted Input Histogram

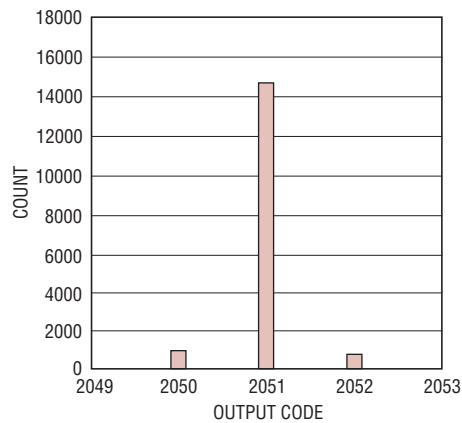

217212 G08

LTC2172-12: SNR vs Input Frequency, -1dBFS , 2V Range, 65Mpsps

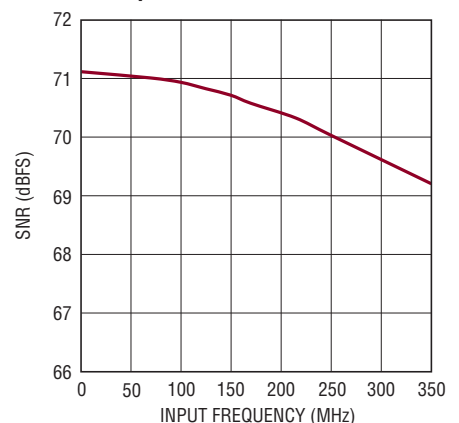

217212 G09

21721012fa

TYPICAL PERFORMANCE CHARACTERISTICS

LTC2172-12: SFDR vs Input Frequency, -1dBFS, 2V Range, 65Msps

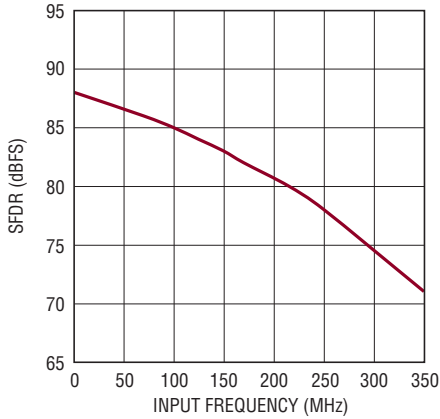

217212 G10

LTC2172-12: SFDR vs Input Level, $f_{IN} = 70\text{MHz}$, 2V Range, 65Msps

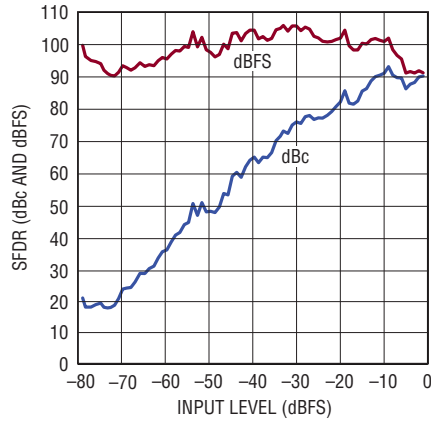

217212 G12

LTC2172-12: SNR vs Input Level, $f_{IN} = 70\text{MHz}$, 2V Range, 65Msps

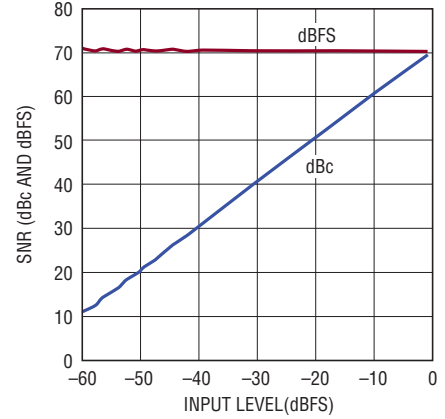

217212 G50

LTC2172-12: I_{VDD} vs Sample Rate, 5MHz Sine Wave Input, -1dBFS

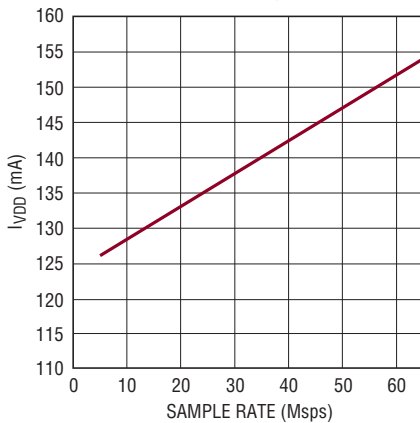

217212 G53

I_{O_VDD} vs Sample Rate, 5MHz Sine Wave Input, -1dBFS

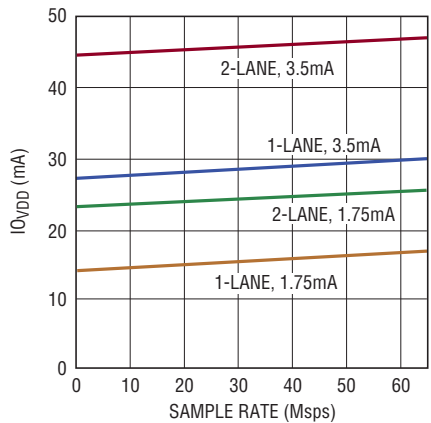

217212 G51

LTC2172-12: SNR vs SENSE, $f_{IN} = 5\text{MHz}$, -1dBFS

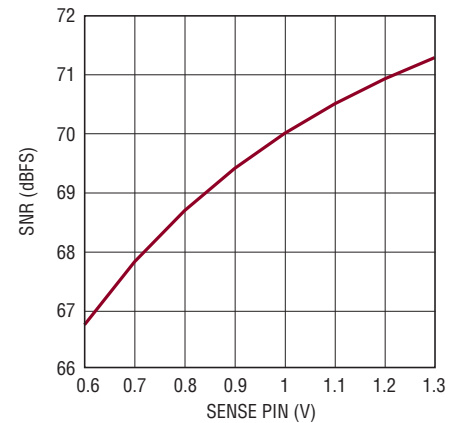

217212 G15

LTC2171-12: Integral Nonlinearity (INL)

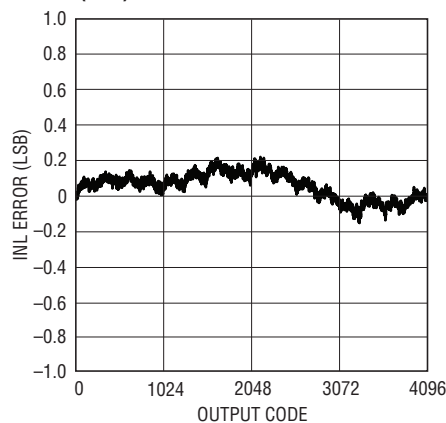

217212 G21

LTC2171-12: Differential Nonlinearity (DNL)

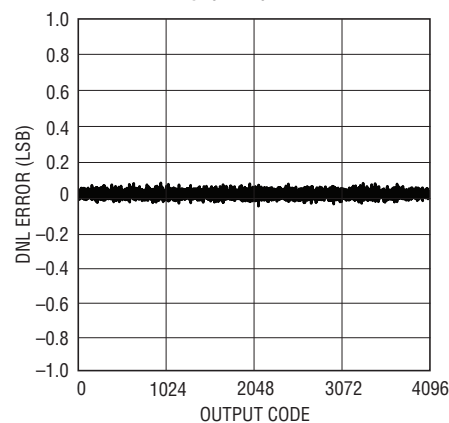

217212 G22

LTC2171-12: 8k Point FFT, $f_{IN} = 5\text{MHz}$, -1dBFS, 40Msps

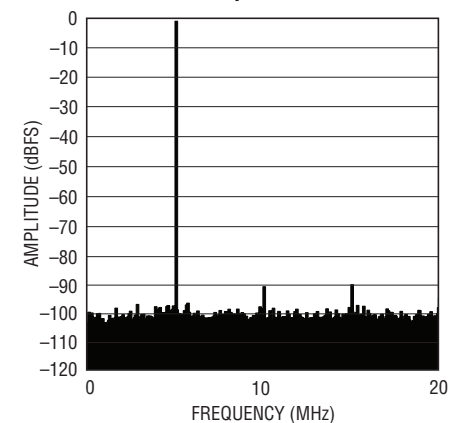

217212 G23

21721012fa

TYPICAL PERFORMANCE CHARACTERISTICS

LTC2171-12: 8k Point FFT, $f_{IN} = 29\text{MHz}$
-1dBFS, 40Msps

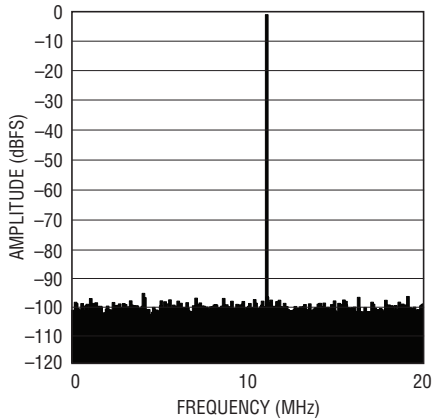

217212 G24

LTC2171-12: 8k Point FFT, $f_{IN} = 69\text{MHz}$
-1dBFS, 40Msps

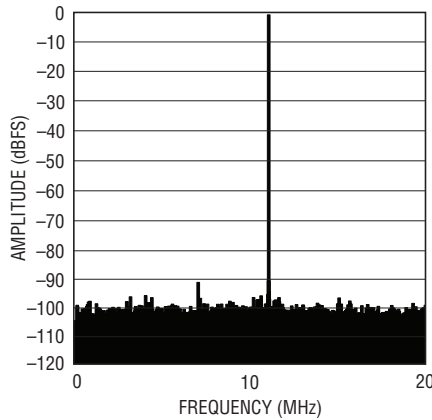

217212 G25

LTC2171-12: 8k Point FFT, $f_{IN} = 139\text{MHz}$
-1dBFS, 40Msps

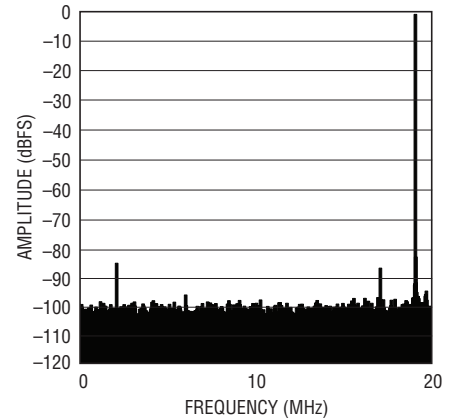

217212 G26

LTC2171-12: 8k Point 2-Tone FFT,
 $f_{IN} = 68\text{MHz}, 69\text{MHz}$, -1dBFS,
40Msps

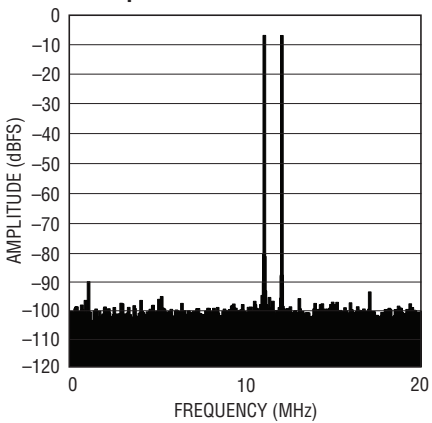

217212 G27

LTC2171-12: Shorted Input
Histogram

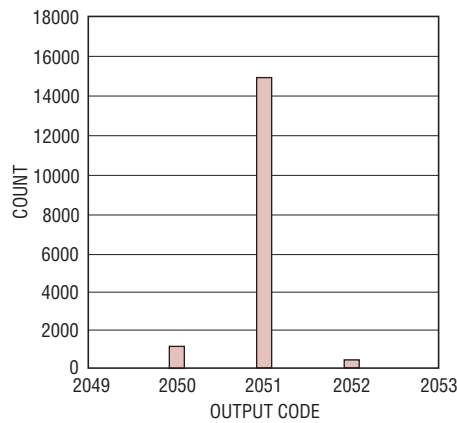

217212 G28

LTC2171-12: SNR vs Input
Frequency, -1dBFS, 2V Range,
40Msps

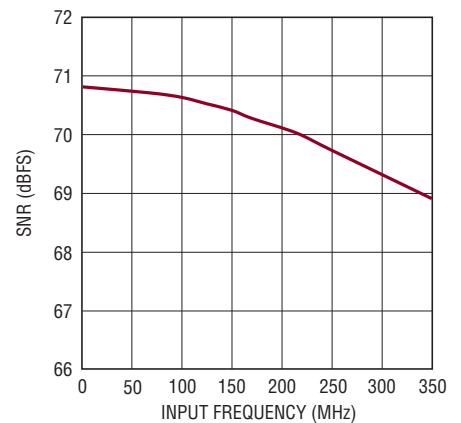

217212 G29

LTC2171-12: SFDR vs Input
Frequency, -1dBFS, 2V Range,
40Msps

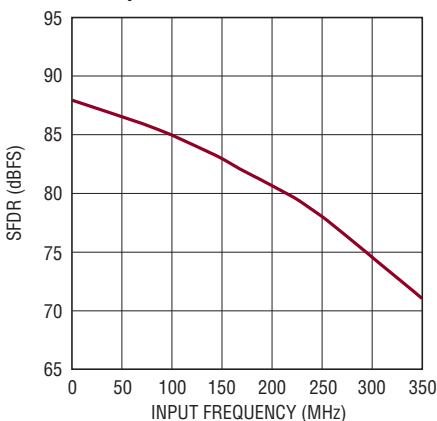

217212 G24a

LTC2171-12: SFDR vs Input Level,
 $f_{IN} = 70\text{MHz}$, 2V Range, 40Msps

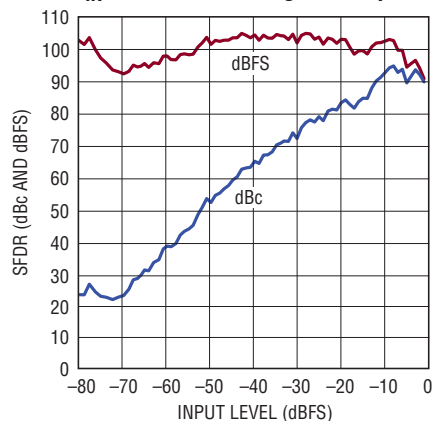

217212 G32

LTC2171-12: I_{VDD} vs Sample Rate,
5MHz Sine Wave Input, -1dBFS

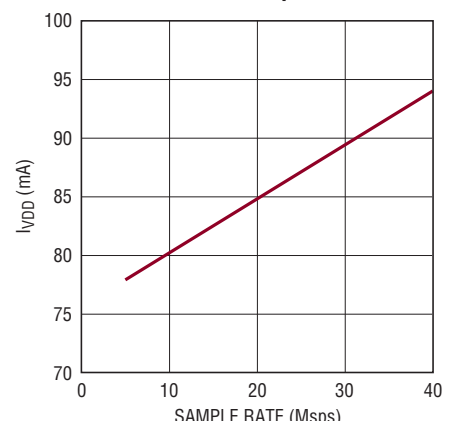

217212 G54

21721012fa

TYPICAL PERFORMANCE CHARACTERISTICS

LTC2171-12: SNR vs SENSE,
 $f_{IN} = 5\text{MHz}$, -1dBFS

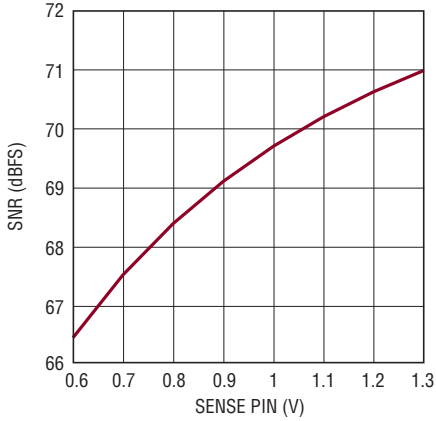

217212 G35

LTC2170-12: Integral Nonlinearity (INL)

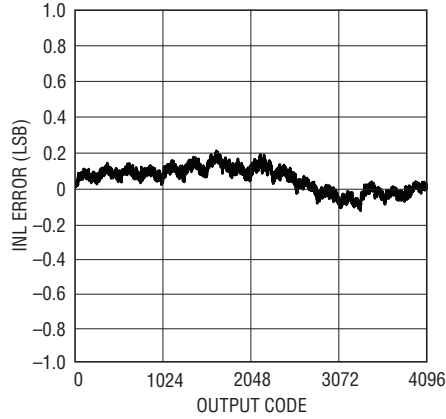

217212 G41

LTC2170-12: Differential Nonlinearity (DNL)

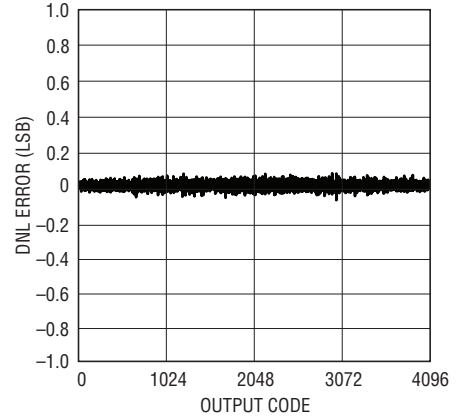

217212 G42

LTC2170-12: 8k Point FFT, $f_{IN} = 5\text{MHz}$
 -1dBFS , 25Mps

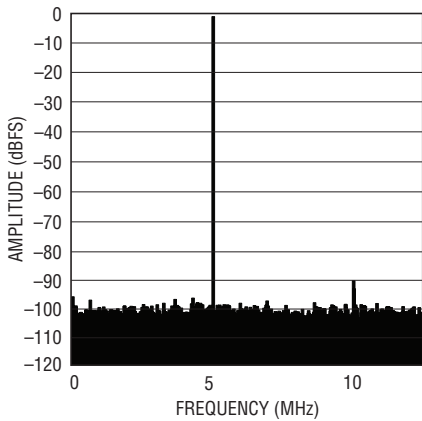

217212 G43

LTC2170-12: 8k Point FFT, $f_{IN} = 30\text{MHz}$
 -1dBFS , 25Mps

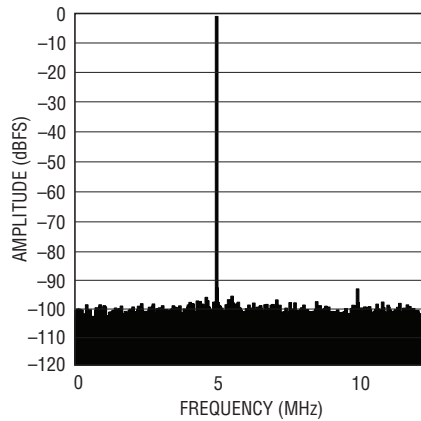

217212 G44

LTC2170-12: 8k Point FFT, $f_{IN} = 70\text{MHz}$
 -1dBFS , 25Mps

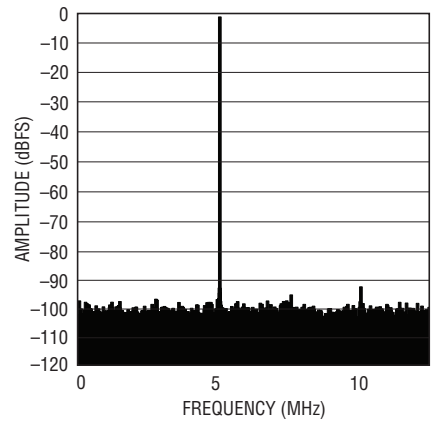

217212 G45

LTC2170-12: 8k Point FFT,
 $f_{IN} = 140\text{MHz}$ -1dBFS , 25Mps

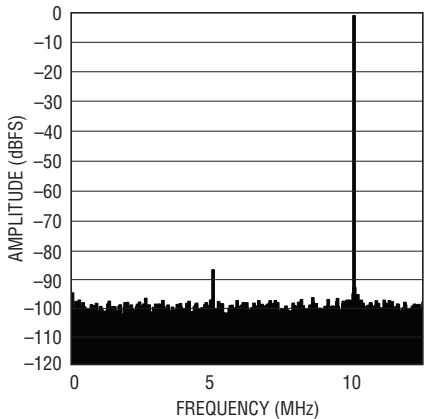

217212 G46

LTC2170-12: 8k Point 2-Tone FFT,
 $f_{IN} = 68\text{MHz}$, 69MHz , -1dBFS ,
25Mps

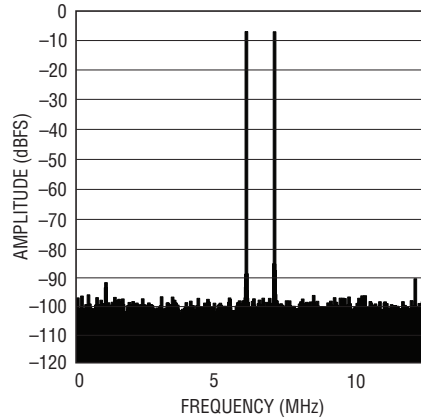

217212 G47

LTC2170-12: Shorted Input Histogram

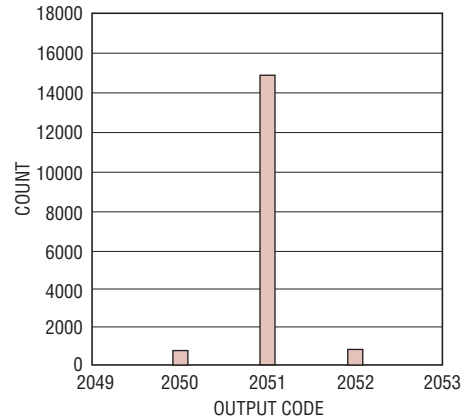

217212 G48

21721012fa

TYPICAL PERFORMANCE CHARACTERISTICS

LTC2170-12: SNR vs Input Frequency, -1dBFS, 2V Range, 25Msps

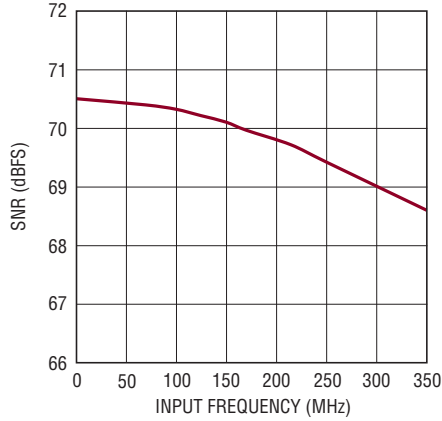

217212 G49

LTC2170-12: SFDR vs Input Frequency, -1dBFS, 2V Range, 25Msps

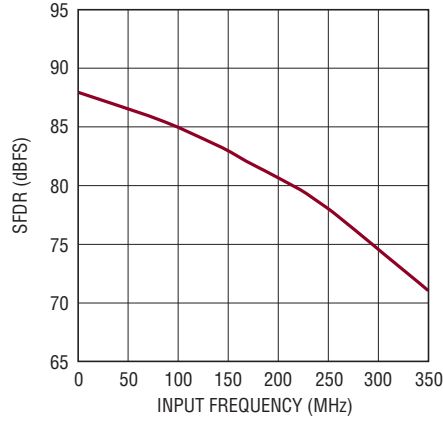

217212 G37

LTC2170-12: SFDR vs Input Level, $f_{IN} = 70\text{MHz}$, 2V Range, 25Msps

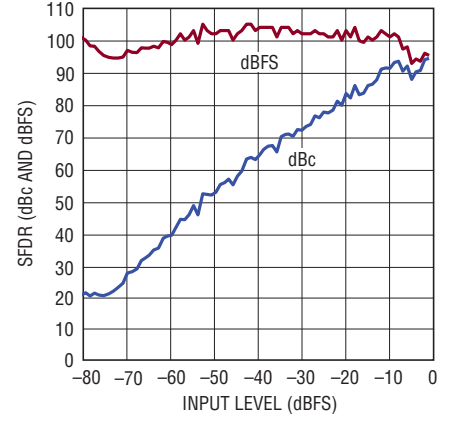

217212 G52

LTC2170-12: I_{VDD} vs Sample Rate, 5MHz Sine Wave Input, -1dBFS

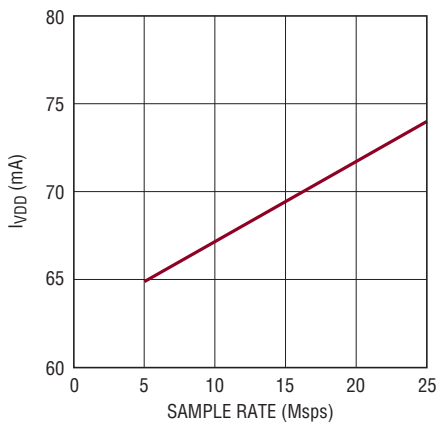

217212 G55

LTC2170-12: SNR vs SENSE, $f_{IN} = 5\text{MHz}$, -1dBFS

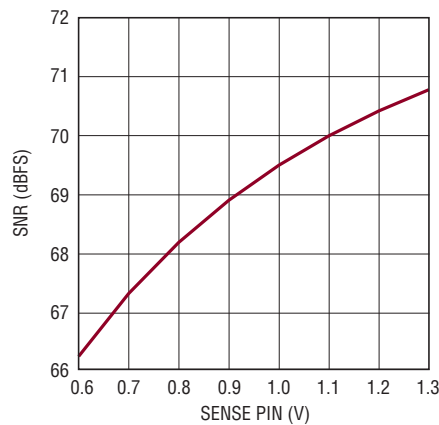

217212 G55a

DCO Cycle-Cycle Jitter vs Serial Data Rate

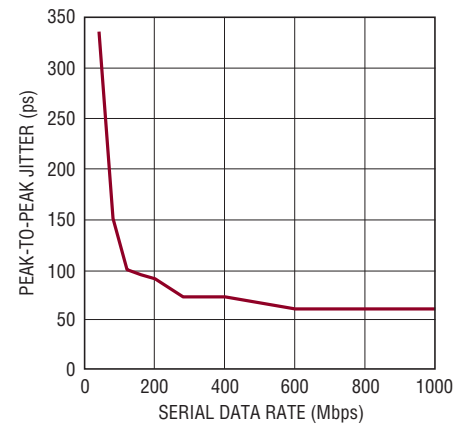

217212 G52

PIN FUNCTIONS

A_{IN1}⁺ (Pin 1): Channel 1 Positive Differential Analog Input.

A_{IN1}⁻ (Pin 2): Channel 1 Negative Differential Analog Input.

V_{CM12} (Pin 3): Common Mode Bias Output, Nominally Equal to V_{DD}/2. V_{CM} should be used to bias the common mode of the analog inputs of channels 1 and 2. Bypass to ground with a 0.1μF ceramic capacitor.

A_{IN2}⁺ (Pin 4): Channel 2 Positive Differential Analog Input.

A_{IN2}⁻ (Pin 5): Channel 2 Negative Differential Analog Input.

REFH (Pins 6, 7): ADC High Reference. Bypass to Pin 8 and Pin 9 with a 2.2μF ceramic capacitor, and to ground with a 0.1μF ceramic capacitor.

REFL (Pins 8, 9): ADC Low Reference. Bypass to Pin 6 and Pin 7 with a 2.2μF ceramic capacitor, and to ground with a 0.1μF ceramic capacitor.

A_{IN3}⁺ (Pin 10): Channel 3 Positive Differential Analog Input.

A_{IN3}⁻ (Pin 11): Channel 3 Negative Differential Analog Input.

V_{CM34} (Pin 12): Common Mode Bias Output, Nominally Equal to V_{DD}/2. V_{CM} should be used to bias the common mode of the analog inputs of channels 3 and 4. Bypass to ground with a 0.1μF ceramic capacitor.

A_{IN4}⁺ (Pin 13): Channel 4 Positive Differential Analog Input.

A_{IN4}⁻ (Pin 14): Channel 4 Negative Differential Analog Input.

V_{DD} (Pins 15, 16, 51, 52): Analog Power Supply, 1.7V to 1.9V. Bypass to ground with 0.1μF ceramic capacitors. Adjacent pins can share a bypass capacitor.

ENC⁺ (Pin 17): Encode Input. Conversion starts on the rising edge.

ENC⁻ (Pin 18): Encode Complement Input. Conversion starts on the falling edge.

CS (Pin 19): In serial programming mode (PAR/SER = 0V), CS is the serial interface chip select input. When CS is low, SCK is enabled for shifting data on SDI into the mode control registers. In parallel programming mode (PAR/SER = V_{DD}), CS selects two-lane or one-lane output mode. CS can be driven with 1.8V to 3.3V logic.

SCK (Pin 20): In serial programming mode (PAR/SER = 0V), SCK is the serial interface clock input. In parallel programming mode (PAR/SER = V_{DD}), SCK selects 3.5mA or 1.75mA LVDS output currents. SCK can be driven with 1.8V to 3.3V logic.

SDI (Pin 21): In serial programming mode (PAR/SER = 0V), SDI is the serial interface data input. Data on SDI is clocked into the mode control registers on the rising edge of SCK. In parallel programming mode (PAR/SER = V_{DD}), SDI can be used to power down the part. SDI can be driven with 1.8V to 3.3V logic.

GND (Pins 22, 45, 49, Exposed Pad Pin 53): ADC Power Ground. The exposed pad must be soldered to the PCB ground.

OGND (Pin 33): Output Driver Ground. Must be shorted to the ground plane by a very low inductance path. Use multiple vias close to the pin.

OV_{DD} (Pin 34): Output Driver Supply, 1.7V to 1.9V. Bypass to ground with a 0.1μF ceramic capacitor.

SDO (Pin 46): In serial programming mode (PAR/SER = 0V), SDO is the optional serial interface data output. Data on SDO is read back from the mode control registers and can be latched on the falling edge of SCK. SDO is an open-drain N-channel MOSFET output that requires an external 2k pull-up resistor of 1.8V to 3.3V. If readback from the mode control registers is not needed, the pull-up resistor is not necessary and SDO can be left unconnected. In parallel programming mode (PAR/SER = V_{DD}), SDO is an input that enables internal 100Ω termination resistors on the digital outputs. When used as an input, SDO can be driven with 1.8V to 3.3V logic through a 1k series resistor.

PIN FUNCTIONS

PAR/SER (Pin 47): Programming Mode Selection Pin. Connect to ground to enable serial programming mode. \overline{CS} , SCK, SDI and SDO become a serial interface that controls the A/D operating modes. Connect to V_{DD} to enable parallel programming mode where \overline{CS} , SCK, SDI and SDO become parallel logic inputs that control a reduced set of the A/D operating modes. PAR/SER should be connected directly to ground or the V_{DD} of the part and not be driven by a logic signal.

V_{REF} (Pin 48): Reference Voltage Output. Bypass to ground with a 1 μ F ceramic capacitor, nominally 1.25V.

SENSE (Pin 50): Reference Programming Pin. Connecting SENSE to V_{DD} selects the internal reference and a $\pm 1V$ input range. Connecting SENSE to ground selects the internal reference and a $\pm 0.5V$ input range. An external reference between 0.625V and 1.3V applied to SENSE selects an input range of $\pm 0.8 \cdot V_{SENSE}$.

LVDS OUTPUTS

The following pins are differential LVDS outputs. The output current level is programmable. There is an optional internal 100 Ω termination resistor between the pins of each LVDS output pair.

OUT4B⁻/OUT4B⁺, OUT4A⁻/OUT4A⁺ (Pins 23/24, Pins 25/26): Serial Data Outputs for Channel 4. In 1-lane output mode, only OUT4A⁻/OUT4A⁺ are used.

OUT3B⁻/OUT3B⁺, OUT3A⁻/OUT3A⁺ (Pins 27/28, Pins 29/30): Serial Data Outputs for Channel 3. In 1-lane output mode, only OUT3A⁻/OUT3A⁺ are used.

FR⁻/FR⁺ (Pin 31/Pin 32): Frame Start Output.

DCO⁻/DCO⁺ (Pin 35/Pin 36): Data Clock Output.

OUT2B⁻/OUT2B⁺, OUT2A⁻/OUT2A⁺ (Pins 37/38, Pins 39/40): Serial Data Outputs for Channel 2. In 1-lane output mode, only OUT2A⁻/OUT2A⁺ are used.

OUT1B⁻/OUT1B⁺, OUT1A⁻/OUT1A⁺ (Pins 41/42, Pins 43/44): Serial Data Outputs for Channel 1. In 1-lane output mode, only OUT1A⁻/OUT1A⁺ are used.

FUNCTIONAL BLOCK DIAGRAM

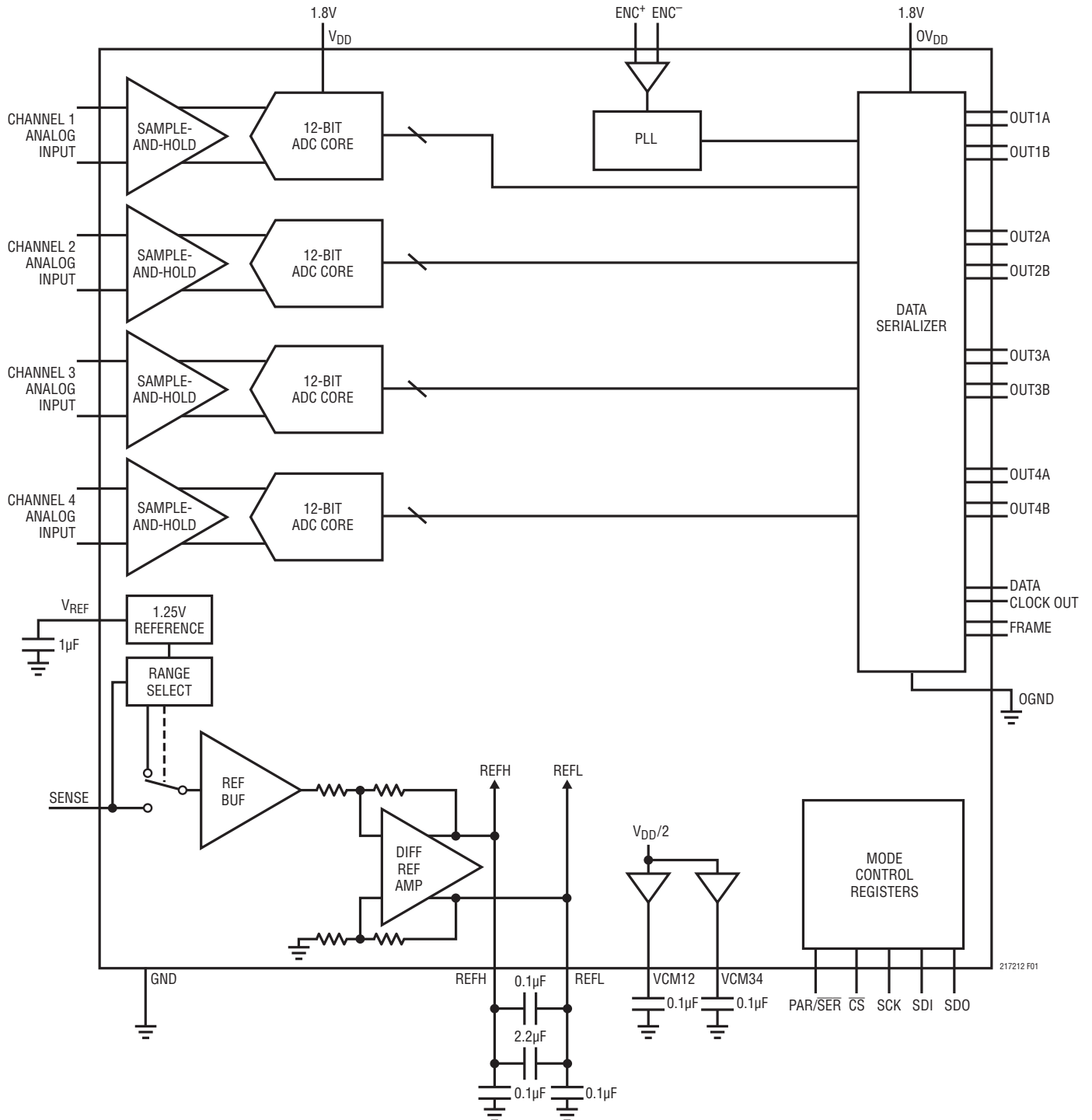

Figure 1. Functional Block Diagram

APPLICATIONS INFORMATION

CONVERTER OPERATION

The LTC2172-12/LTC2171-12/LTC2170-12 are low power, 4-channel, 12-bit, 65MSPS/40MSPS/25MSPS A/D converters that are powered by a single 1.8V supply. The analog inputs should be driven differentially. The encode input can be driven differentially for optimal jitter performance, or single-ended for lower power consumption. The digital outputs are serial LVDS to minimize the number of data lines. Each channel outputs two bits at a time (2-lane mode) or one bit at a time (1-lane mode). Many additional features can be chosen by programming the mode control registers through a serial SPI port.

ANALOG INPUT

The analog inputs are differential CMOS sample-and-hold circuits (Figure 2). The inputs should be driven differentially around a common mode voltage set by the V_{CM12}

or V_{CM34} output pins, which are nominally $V_{DD}/2$. For the 2V input range, the inputs should swing from $V_{CM} - 0.5V$ to $V_{CM} + 0.5V$. There should be a 180° phase difference between the inputs.

The four channels are simultaneously sampled by a shared encode circuit (Figure 2).

INPUT DRIVE CIRCUITS

Input Filtering

If possible, there should be an RC lowpass filter right at the analog inputs. This lowpass filter isolates the drive circuitry from the A/D sample-and-hold switching and limits wideband noise from the drive circuitry. Figure 3 shows an example of an input RC filter. The RC component values should be chosen based on the application's input frequency.

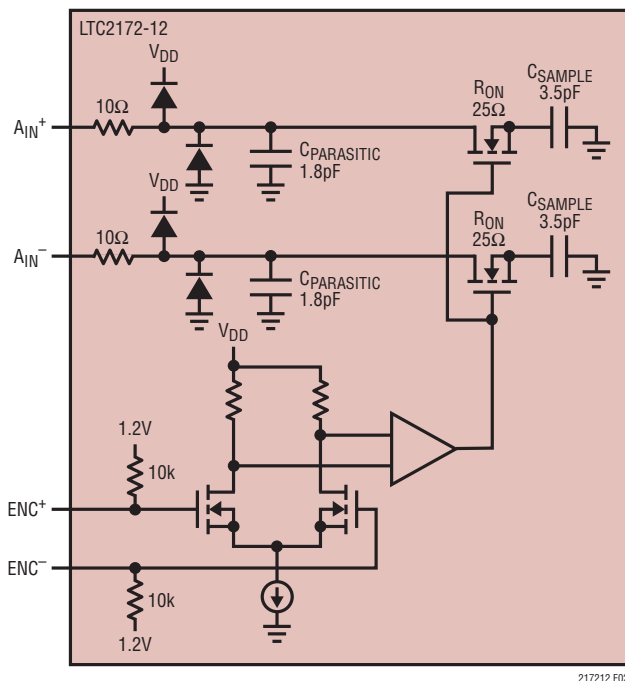

Figure 2. Equivalent Input Circuit. Only One of the Four Analog Channels Is Shown.

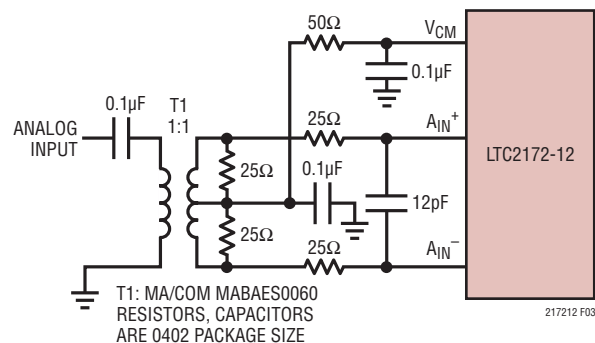
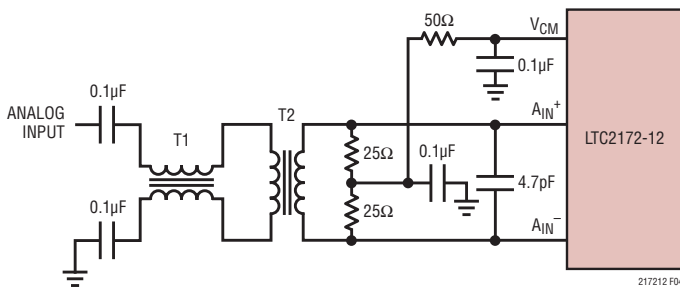

Figure 3. Analog Input Circuit Using a Transformer. Recommended for Input Frequencies from 5MHz to 70MHz

APPLICATIONS INFORMATION

Transformer Coupled Circuits

Figure 3 shows the analog input being driven by an RF transformer with a center-tapped secondary. The center tap is biased with V_{CM} , setting the A/D input at its optimal DC level. At higher input frequencies a transmission line balun transformer (Figures 4 to 6) has better balance, resulting in lower A/D distortion.



T1: MA/COM MABA-007159-000000
T2: MA/COM MABAES0060
RESISTORS, CAPACITORS ARE 0402 PACKAGE SIZE

Figure 4. Recommended Front-End Circuit for Input Frequencies from 70MHz to 170MHz

Amplifier Circuits

Figure 7 shows the analog input being driven by a high speed differential amplifier. The output of the amplifier is AC-coupled to the A/D so the amplifier's output common mode voltage can be optimally set to minimize distortion.

At very high frequencies an RF gain block will often have lower distortion than a differential amplifier. If the gain block is single-ended, then a transformer circuit (Figures 4 to 6) should convert the signal to differential before driving the A/D.

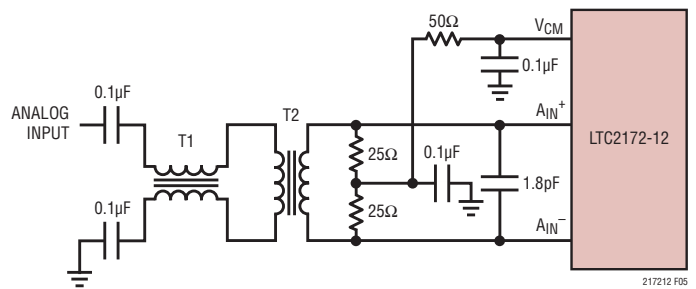

T1: MA/COM MABA-007159-000000
T2: COILCRAFT WBC1-1LB
RESISTORS, CAPACITORS ARE 0402 PACKAGE SIZE

Figure 5. Recommended Front-End Circuit for Input Frequencies from 170MHz to 300MHz

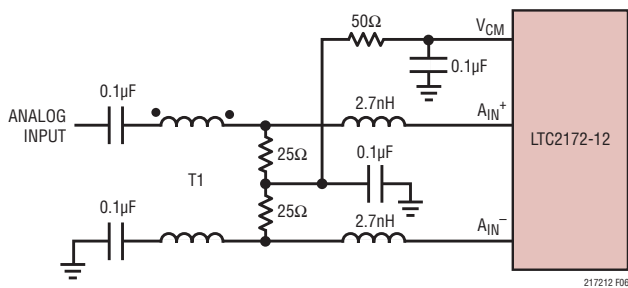

T1: MA/COM ETC1-1-13
RESISTORS, CAPACITORS
ARE 0402 PACKAGE SIZE

Figure 6. Recommended Front-End Circuit for Input Frequencies Above 300MHz

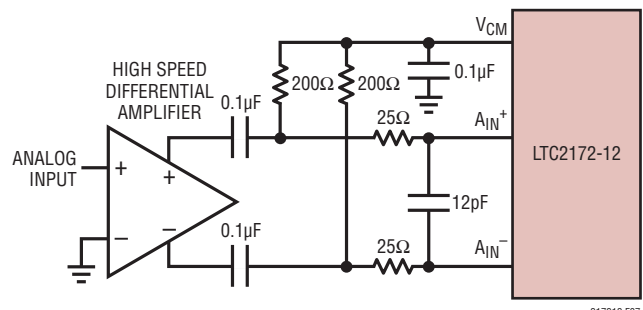

Figure 7. Front-End Circuit Using a High Speed Differential Amplifier

APPLICATIONS INFORMATION

Reference

The LTC2172-12/LTC2171-12/LTC2170-12 has an internal 1.25V voltage reference. For a 2V input range using the internal reference, connect SENSE to V_{DD} . For a 1V input range using the internal reference, connect SENSE to ground. For a 2V input range with an external reference, apply a 1.25V reference voltage to SENSE (Figure 9).

The input range can be adjusted by applying a voltage to SENSE that is between 0.625V and 1.30V. The input range will then be $1.6 \cdot V_{SENSE}$.

The reference is shared by all four ADC channels, so it is not possible to independently adjust the input range of individual channels.

The V_{REF} , REFH and REFL pins should be bypassed, as shown in Figure 8. The 0.1 μ F capacitor between REFH and REFL should be as close to the pins as possible (not on the backside of the circuit board).

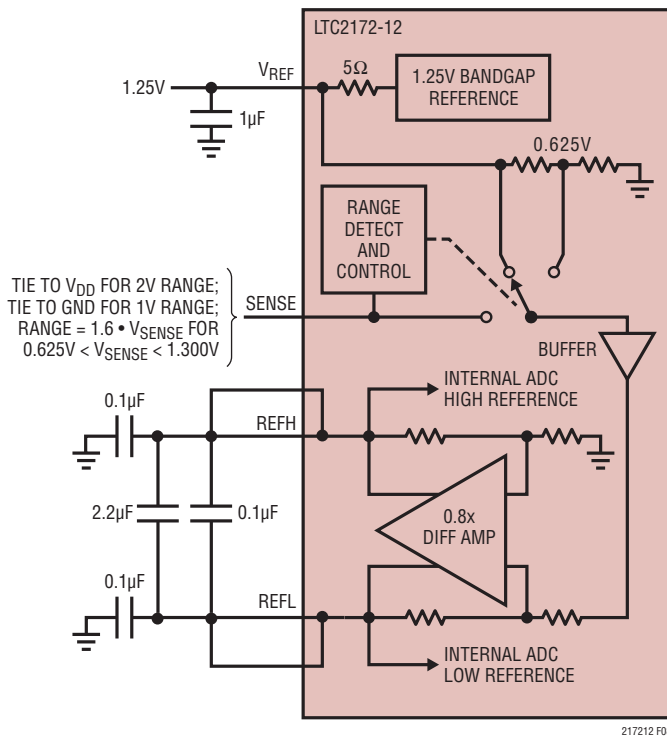

Figure 8. Reference Circuit

Encode Input

The signal quality of the encode inputs strongly affects the A/D noise performance. The encode inputs should be treated as analog signals—do not route them next to digital traces on the circuit board. There are two modes of operation for the encode inputs: the differential encode mode (Figure 10), and the single-ended encode mode (Figure 11).

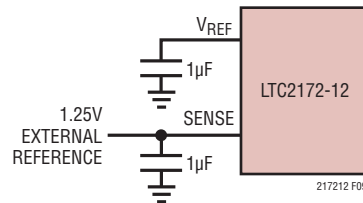

Figure 9. Using an External 1.25V Reference

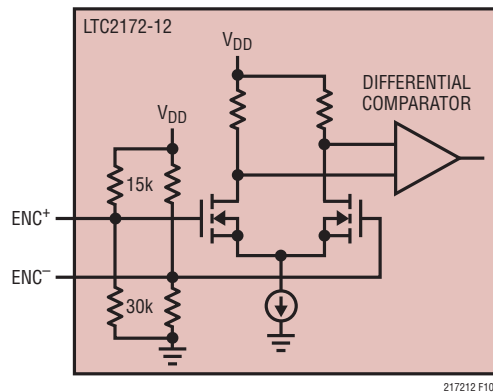

Figure 10. Equivalent Encode Input Circuit for Differential Encode Mode

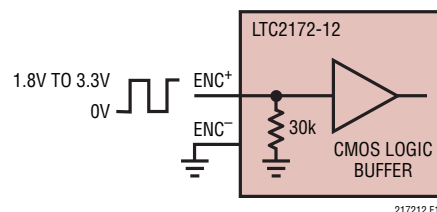

Figure 11. Equivalent Encode Input Circuit for Single-Ended Encode Mode

APPLICATIONS INFORMATION

The differential encode mode is recommended for sinusoidal, PECL, or LVDS encode inputs (Figures 12 and 13). The encode inputs are internally biased to 1.2V through 10k equivalent resistance. The encode inputs can be taken above V_{DD} (up to 3.6V), and the common mode range is from 1.1V to 1.6V. In the differential encode mode, ENC^- should stay at least 200mV above ground to avoid falsely triggering the single-ended encode mode. For good jitter performance ENC^+ should have fast rise and fall times.

The single-ended encode mode should be used with CMOS encode inputs. To select this mode, ENC^- is connected to ground and ENC^+ is driven with a square wave encode input. ENC^+ can be taken above V_{DD} (up to 3.6V) so 1.8V to 3.3V CMOS logic levels can be used. The ENC^+ threshold is 0.9V. For good jitter performance ENC^+ should have fast rise and fall times.

Clock PLL and Duty Cycle Stabilizer

The encode clock is multiplied by an internal phase-locked loop (PLL) to generate the serial digital output data. If the encode signal changes frequency or is turned off, the PLL requires 25 μ s to lock onto the input clock.

A clock duty cycle stabilizer circuit allows the duty cycle of the applied encode signal to vary from 30% to 70%.

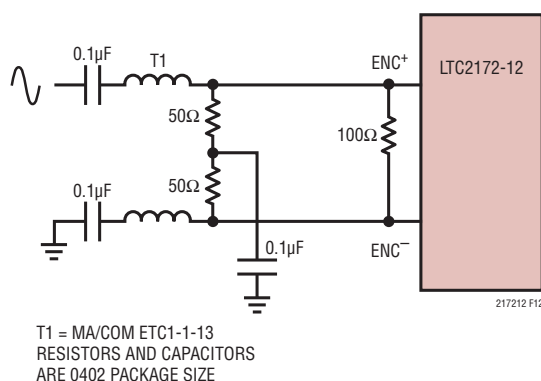

Figure 12. Sinusoidal Encode Drive

In the serial programming mode it is possible to disable the duty cycle stabilizer, but this is not recommended. In the parallel programming mode the duty cycle stabilizer is always enabled.

DIGITAL OUTPUTS

The digital outputs of the LTC2172-12/LTC2171-12/LTC2170-12 are serialized LVDS signals. Each channel outputs two bits at a time (2-lane mode) or one bit at a time (1-lane mode). The data can be serialized with 16-, 14-, or 12-bit serialization (see the Timing Diagrams section for details).

The output data should be latched on the rising and falling edges of the data clockout (DCO). A data frame output (FR) can be used to determine when the data from a new conversion result begins. In the 2-lane, 14-bit serialization mode, the frequency of the FR output is halved.

The maximum serial data rate for the data outputs is 1Gbps, so the maximum sample rate of the ADC will depend on the serialization mode as well as the speed grade of the ADC (see Table 1). The minimum sample rate for all serialization modes is 5Mps.

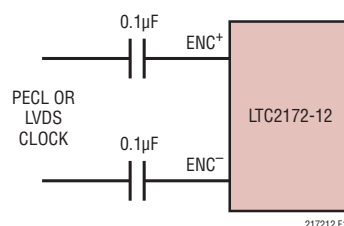

Figure 13. PECL or LVDS Encode Drive

APPLICATIONS INFORMATION

Table 1. Maximum Sampling Frequency for All Serialization Modes. Note That These Limits Are for the LTC2172-12. The Sampling Frequency for the Slower Speed Grades Cannot Exceed 40MHz (LTC2171-12) or 25MHz (LTC2170-12).

SERIALIZATION MODE		MAXIMUM SAMPLING FREQUENCY, f_S (MHz)	DCO FREQUENCY	FR FREQUENCY	SERIAL DATA RATE
2-Lane	16-Bit Serialization	65	$4 \cdot f_S$	f_S	$8 \cdot f_S$
2-Lane	14-Bit Serialization	65	$3.5 \cdot f_S$	$0.5 \cdot f_S$	$7 \cdot f_S$
2-Lane	12-Bit Serialization	65	$3 \cdot f_S$	f_S	$6 \cdot f_S$
1-Lane	16-Bit Serialization	62.5	$8 \cdot f_S$	f_S	$16 \cdot f_S$
1-Lane	14-Bit Serialization	65	$7 \cdot f_S$	f_S	$14 \cdot f_S$
1-Lane	12-Bit Serialization	65	$6 \cdot f_S$	f_S	$12 \cdot f_S$

By default the outputs are standard LVDS levels: a 3.5mA output current and a 1.25V output common mode voltage. An external 100Ω differential termination resistor is required for each LVDS output pair. The termination resistors should be located as close as possible to the LVDS receiver.

The outputs are powered by OV_{DD} and $OGND$ which are isolated from the A/D core power and ground.

Programmable LVDS Output Current

The default output driver current is 3.5mA. This current can be adjusted by control register A2 in serial programming mode. Available current levels are 1.75mA, 2.1mA, 2.5mA, 3mA, 3.5mA, 4mA and 4.5mA. In parallel programming mode the SCK pin can select either 3.5mA or 1.75mA.

Optional LVDS Driver Internal Termination

In most cases, using just an external 100Ω termination resistor will give excellent LVDS signal integrity. In addition, an optional internal 100Ω termination resistor can be enabled by serially programming mode control register A2. The internal termination helps absorb any reflections caused by imperfect termination at the receiver. When the internal termination is enabled, the output driver current is doubled to maintain the same output voltage swing. In parallel programming mode the SDO pin enables internal termination. Internal termination should only be used with 1.75mA, 2.1mA or 2.5mA LVDS output current modes.

DATA FORMAT

Table 2 shows the relationship between the analog input voltage and the digital data output bits. By default the output data format is offset binary. The 2's complement format can be selected by serially programming mode control register A1.

In addition to the 12 data bits (D11 - D0), two additional bits (D_X and D_Y) are sent out in the 14-bit and 16-bit serialization modes. These extra bits are to ensure complete software compatibility with the 14-bit versions of these A/Ds. During normal operation when the analog inputs are not overranged, D_X and D_Y are always logic 0. When the analog inputs are overranged positive, D_X and D_Y become logic 1. When the analog inputs are overranged negative, D_X and D_Y become logic 0. D_X and D_Y can also be controlled by the digital output test pattern. See the Timing Diagrams section for more information.

Table 2. Output Codes vs Input Voltage

$A_{IN}^+ - A_{IN}^-$ (2V RANGE)	D11-D0 (OFFSET BINARY)	D11-D0 (2's COMPLEMENT)	D_X, D_Y
>+1.000000V	1111 1111 1111	0111 1111 1111	11
+0.999512V	1111 1111 1111	0111 1111 1111	00
+0.999024V	1111 1111 1110	0111 1111 1110	00
+0.000488V	1000 0000 0001	0000 0000 0001	00
0.000000V	1000 0000 0000	0000 0000 0000	00
-0.000488V	0111 1111 1111	1111 1111 1111	00
-0.000976V	0111 1111 1110	1111 1111 1110	00
-0.999512V	0000 0000 0001	1000 0000 0001	00
-1.000000V	0000 0000 0000	1000 0000 0000	00
≤-1.000000V	0000 0000 0000	1000 0000 0000	00

APPLICATIONS INFORMATION

Digital Output Randomizer

Interference from the A/D digital outputs is sometimes unavoidable. Digital interference may be from capacitive or inductive coupling or coupling through the ground plane. Even a tiny coupling factor can cause unwanted tones in the ADC output spectrum. These unwanted tones can be randomized by randomizing the digital output before it is transmitted off chip, which reduces the unwanted tone amplitude.

The digital output is *randomized* by applying an exclusive-OR logic operation between the LSB and all other data output bits. To decode, the reverse operation is applied—an exclusive-OR operation is applied between the LSB and all other bits. The FR and DCO outputs are not affected. The output randomizer is enabled by serially programming mode control register A1.

Digital Output Test Pattern

To allow in-circuit testing of the digital interface to the A/D, there is a test mode that forces the A/D data outputs (D11-D0, D_X, D_Y) of all channels to known values. The digital output test patterns are enabled by serially programming mode control registers A3 and A4. When enabled, the test patterns override all other formatting modes: 2's complement and randomizer.

Output Disable

The digital outputs may be disabled by serially programming mode control register A2. The current drive for all digital outputs, including DCO and FR, are disabled to save power or enable in-circuit testing. When disabled, the common mode of each output pair becomes high impedance, but the differential impedance may remain low.

Sleep and Nap Modes

The A/D may be placed in sleep or nap modes to conserve power. In sleep mode the entire chip is powered down, resulting in 1mW power consumption. Sleep mode is enabled by mode control register A1 (serial programming mode), or by SDI (parallel programming mode). The amount of time required to recover from sleep mode depends on the size of the bypass capacitors on V_{REF}, REFH and REFL. For the suggested values in Figure 8, the A/D will stabilize after 2ms.

In nap mode any combination of A/D channels can be powered down while the internal reference circuits and the PLL stay active, allowing a faster wake-up than from sleep mode. Recovering from nap mode requires at least 100 clock cycles. If the application demands very accurate DC settling, then an additional 50μs should be allowed so the on-chip references can settle from the slight temperature shift caused by the change in supply current as the A/D leaves nap mode. Nap mode is enabled by the mode control register A1 in the serial programming mode.

DEVICE PROGRAMMING MODES

The operating modes of the LTC2172-12/LTC2171-12/LTC2170-12 can be programmed by either a parallel interface or a simple serial interface. The serial interface has more flexibility and can program all available modes. The parallel interface is more limited and can only program some of the more commonly used modes.

Parallel Programming Mode

To use the parallel programming mode, PAR/ $\overline{\text{SER}}$ should be tied to V_{DD}. The $\overline{\text{CS}}$, SCK, SDI and SDO pins are binary logic inputs that set certain operating modes. These pins can be tied to V_{DD} or ground, or driven by 1.8V, 2.5V or 3.3V CMOS logic. When used as an input, SDO should be driven through a 1k series resistor. Table 3 shows the modes set by $\overline{\text{CS}}$, SCK, SDI and SDO.

Table 3. Parallel Programming Mode Control Bits (PAR/ $\overline{\text{SER}}$ = V_{DD})

PIN	DESCRIPTION
$\overline{\text{CS}}$	2-Lane/1-Lane Selection Bit 0 = 2-Lane, 16-Bit Serialization Output Mode 1 = 1-Lane, 14-Bit Serialization Output Mode
SCK	LVDS Current Selection Bit 0 = 3.5mA LVDS Current Mode 1 = 1.75mA LVDS Current Mode
SDI	Power Down Control Bit 0 = Normal Operation 1 = Sleep Mode
SDO	Internal 100Ω Termination Selection Bit 0 = Internal Termination Disabled 1 = Internal Termination Enabled

APPLICATIONS INFORMATION

Serial Programming Mode

To use the serial programming mode, $\overline{\text{PAR/SER}}$ should be tied to ground. The $\overline{\text{CS}}$, SCK, SDI and SDO pins become a serial interface that program the A/D mode control registers. Data is written to a register with a 16-bit serial word. Data can also be read back from a register to verify its contents.

Serial data transfer starts when $\overline{\text{CS}}$ is taken low. The data on the SDI pin is latched at the first 16 rising edges of SCK. Any SCK rising edges after the first 16 are ignored. The data transfer ends when $\overline{\text{CS}}$ is taken high again.

The first bit of the 16-bit input word is the $\overline{\text{R/W}}$ bit. The next seven bits are the address of the register (A6:A0). The final eight bits are the register data (D7:D0).

If the $\overline{\text{R/W}}$ bit is low, the serial data (D7:D0) will be written to the register set by the address bits (A6:A0). If the $\overline{\text{R/W}}$ bit is high, data in the register set by the address bits (A6:

A0) will be read back on the SDO pin (see the Timing Diagrams section). During a readback command the register is not updated and data on SDI is ignored.

The SDO pin is an open-drain output that pulls to ground with a 200 Ω impedance. If register data is read back through SDO, an external 2k pull-up resistor is required. If serial data is only written and readback is not needed, then SDO can be left floating and no pull-up resistor is needed. Table 4 shows a map of the mode control registers.

Software Reset

If serial programming is used, the mode control registers should be programmed as soon as possible after the power supplies turn on and are stable. The first serial command must be a software reset which will reset all register data bits to logic 0. To perform a software reset, bit D7 in the reset register is written with a logic 1. After the reset is complete, bit D7 is automatically set back to zero.

Table 4. Serial Programming Mode Register Map ($\overline{\text{PAR/SER}} = \text{GND}$)

REGISTER A0: RESET REGISTER (ADDRESS 00h)

D7	D6	D5	D4	D3	D2	D1	D0
RESET	X	X	X	X	X	X	X

Bit 7 **RESET** Software Reset Bit
 0 = Not Used
 1 = Software Reset. All Mode Control Registers Are Reset to 00h. The ADC is momentarily placed in SLEEP mode. This Bit Is Automatically Set Back to Zero After the Reset Is Complete

Bits 6-0 Unused, Don't Care Bits.

REGISTER A1: POWER-DOWN REGISTER (ADDRESS 01h)

D7	D6	D5	D4	D3	D2	D1	D0
DCSOFF	RAND	TWOSCOMP	SLEEP	NAP_4	NAP_3	NAP_2	NAP_1

Bit 7 **DCSOFF** Clock Duty Cycle Stabilizer Bit
 0 = Clock Duty Cycle Stabilizer On
 1 = Clock Duty Cycle Stabilizer Off. This is Not Recommended.

Bit 6 **RAND** Data Output Randomizer Mode Control Bit
 0 = Data Output Randomizer Mode Off
 1 = Data Output Randomizer Mode On

Bit 5 **TWOSCOMP** Two's Complement Mode Control Bit
 0 = Offset Binary Data Format
 1 = Two's Complement Data Format

Bits 4-0 **SLEEP:NAP_4:NAP_1** Sleep/Nap Mode Control Bits
 00000 = Normal Operation
 0XXX1 = Channel 1 in Nap Mode
 0XX1X = Channel 2 in Nap Mode
 0X1XX = Channel 3 in Nap Mode
 01XXX = Channel 4 in Nap Mode
 1XXXX = Sleep Mode. All Channels Are Disabled
 Note: Any Combination of Channels Can Be Placed in Nap Mode.

APPLICATIONS INFORMATION

REGISTER A2: OUTPUT MODE REGISTER (ADDRESS 02h)

D7	D6	D5	D4	D3	D2	D1	D0
ILVDS2	ILVDS1	ILVDS0	TERMON	OUTOFF	OUTMODE2	OUTMODE1	OUTMODE0
Bits 7-5	ILVDS2:ILVDS0 LVDS Output Current Bits 000 = 3.5mA LVDS Output Driver Current 001 = 4.0mA LVDS Output Driver Current 010 = 4.5mA LVDS Output Driver Current 011 = Not Used 100 = 3.0mA LVDS Output Driver Current 101 = 2.5mA LVDS Output Driver Current 110 = 2.1mA LVDS Output Driver Current 111 = 1.75mA LVDS Output Driver Current						
Bit 4	TERMON LVDS Internal Termination Bit 0 = Internal Termination Off 1 = Internal Termination On. LVDS Output Driver Current is 2x the Current Set by ILVDS2:ILVDS0. Internal termination should only be used with 1.75mA, 2.1mA or 2.5mA LVDS output current modes.						
Bit 3	OUTOFF Output Disable Bit 0 = Digital Outputs are enabled. 1 = Digital Outputs are disabled.						
Bits 2-0	OUTMODE2:OUTMODE0 Digital Output Mode Control Bits 000 = 2-Lanes, 16-Bit Serialization 001 = 2-Lanes, 14-Bit Serialization 010 = 2-Lanes, 12-Bit Serialization 011 = Not Used 100 = Not Used 101 = 1-Lane, 14-Bit Serialization 110 = 1-Lane, 12-Bit Serialization 111 = 1-Lane, 16-Bit Serialization						

REGISTER A3: TEST PATTERN MSB REGISTER (ADDRESS 03h)

D7	D6	D5	D4	D3	D2	D1	D0
OUTTEST	X	TP11	TP10	TP9	TP8	TP7	TP6
Bit 7	OUTTEST Digital Output Test Pattern Control Bit 0 = Digital Output Test Pattern Off 1 = Digital Output Test Pattern On						
Bit 6	Unused, Don't Care Bit.						
Bits 5-0	TP11:TP6 Test Pattern Data Bits (MSB) TP11:TP6 Set the Test Pattern for Data Bit 11 (MSB) Through Data Bit 6.						

REGISTER A4: TEST PATTERN LSB REGISTER (ADDRESS 04h)

D7	D6	D5	D4	D3	D2	D1	D0
TP5	TP4	TP3	TP2	TP1	TP0	TPX	TPY
Bits 7-2	TP5:TP0 Test Pattern Data Bits (LSB) TP5:TP0 Set the Test Pattern for Data Bit 5 Through Data Bit 0 (LSB).						
Bits 1-0	TPX:TPY Set the Test Pattern for Extra Bits D _X and D _Y . These Bits are for Compatibility with the 14-Bit Version of the A/D.						

APPLICATIONS INFORMATION

GROUNDING AND BYPASSING

The LTC2172-12/LTC2171-12/LTC2170-12 requires a printed circuit board with a clean unbroken ground plane. A multilayer board with an internal ground plane in the first layer beneath the ADC is recommended. Layout for the printed circuit board should ensure that digital and analog signal lines are separated as much as possible. In particular, care should be taken not to run any digital track alongside an analog signal track or underneath the ADC.

High quality ceramic bypass capacitors should be used at the V_{DD} , OV_{DD} , V_{CM} , V_{REF} , REFH and REFL pins. Bypass capacitors must be located as close to the pins as possible. Of particular importance is the 0.1 μ F capacitor between REFH and REFL. This capacitor should be on the same side of the circuit board as the A/D, and as close to the device as possible (1.5mm or less). Size 0402 ceramic capacitors are recommended. The larger 2.2 μ F capacitor

between REFH and REFL can be somewhat further away. The traces connecting the pins and bypass capacitors must be kept short and should be made as wide as possible.

The analog inputs, encode signals and digital outputs should not be routed next to each other. Ground fill and grounded vias should be used as barriers to isolate these signals from each other.

HEAT TRANSFER

Most of the heat generated by the LTC2172-12/LTC2171-12/LTC2170-12 is transferred from the die through the bottom-side exposed pad and package leads onto the printed circuit board. For good electrical and thermal performance, the exposed pad must be soldered to a large grounded pad on the PC board. This pad should be connected to the internal ground planes by an array of vias.

TYPICAL APPLICATIONS

Silkscreen Top

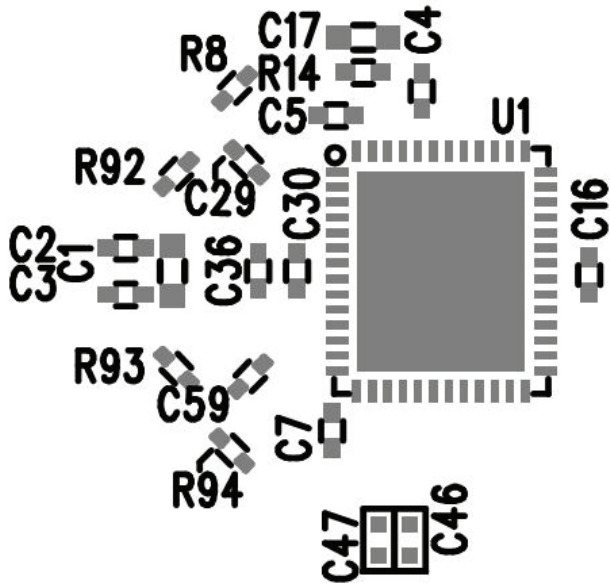

Top Side

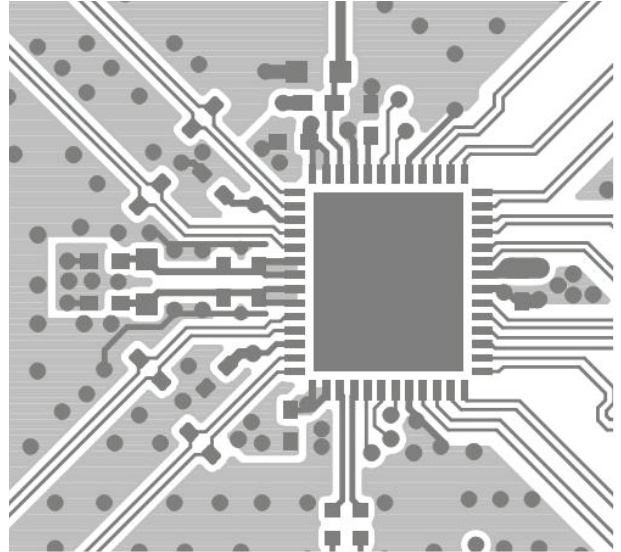

Inner Layer 2 GND

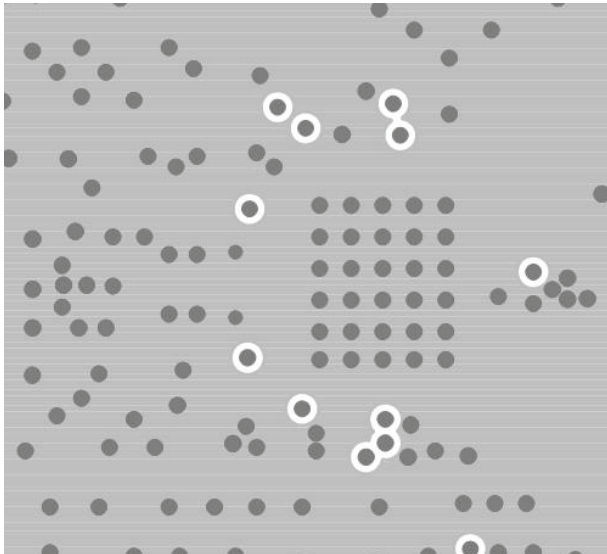

Inner Layer 3

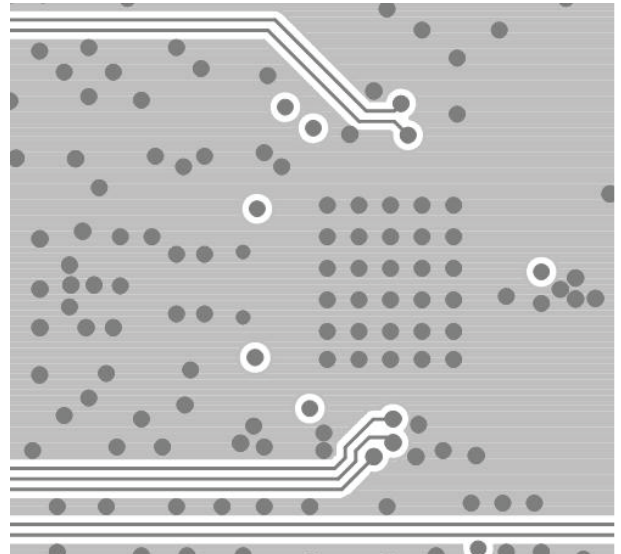

TYPICAL APPLICATIONS

Inner Layer 4

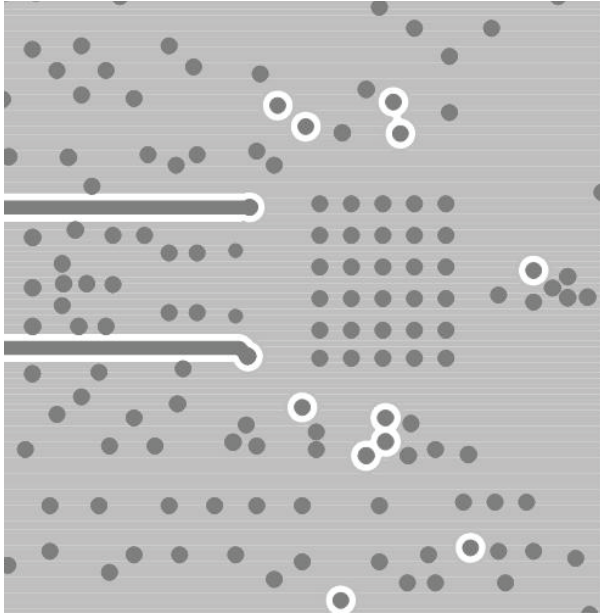

Inner Layer 5 Power

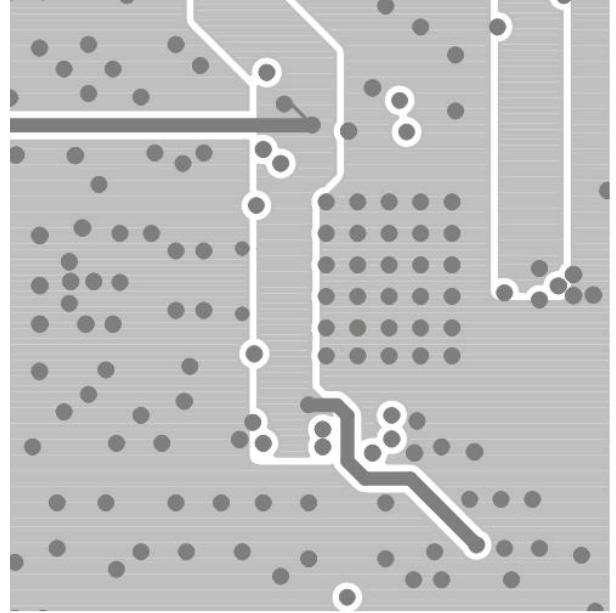

Bottom Side

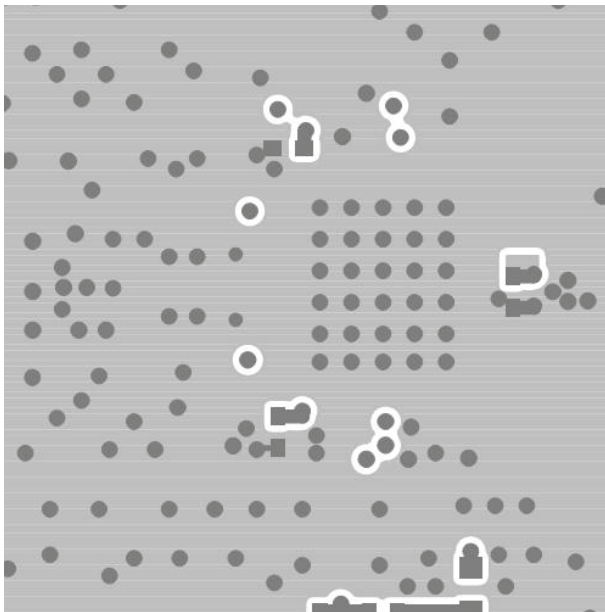

Silkscreen Bottom

C8 □

C9 □

C15 □

TYPICAL APPLICATIONS

LTC2172 Schematic

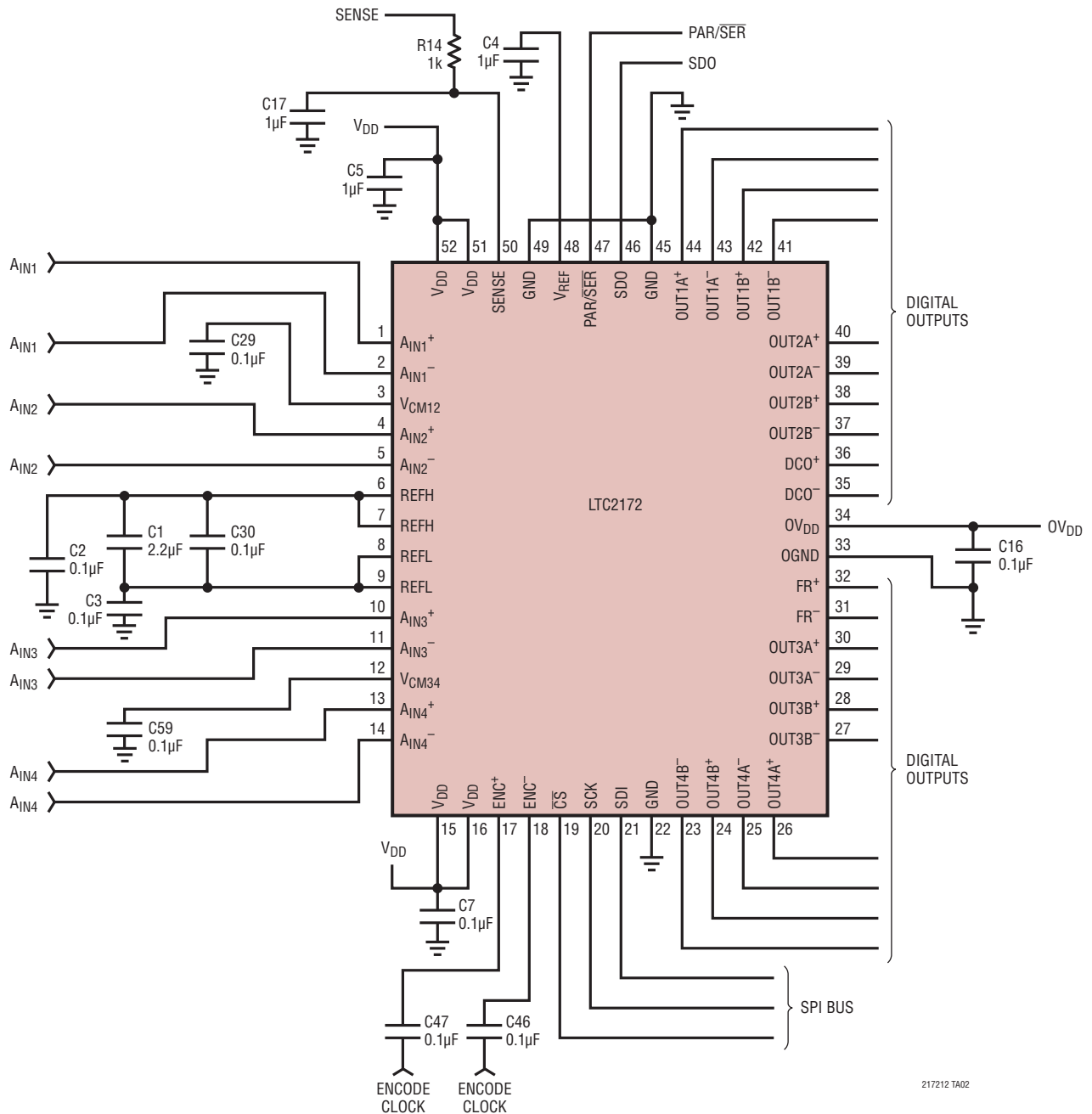

217212 TA02

PACKAGE DESCRIPTION

UKG Package
52-Lead Plastic QFN (7mm × 8mm)
(Reference LTC DWG # 05-08-1729 Rev 0)

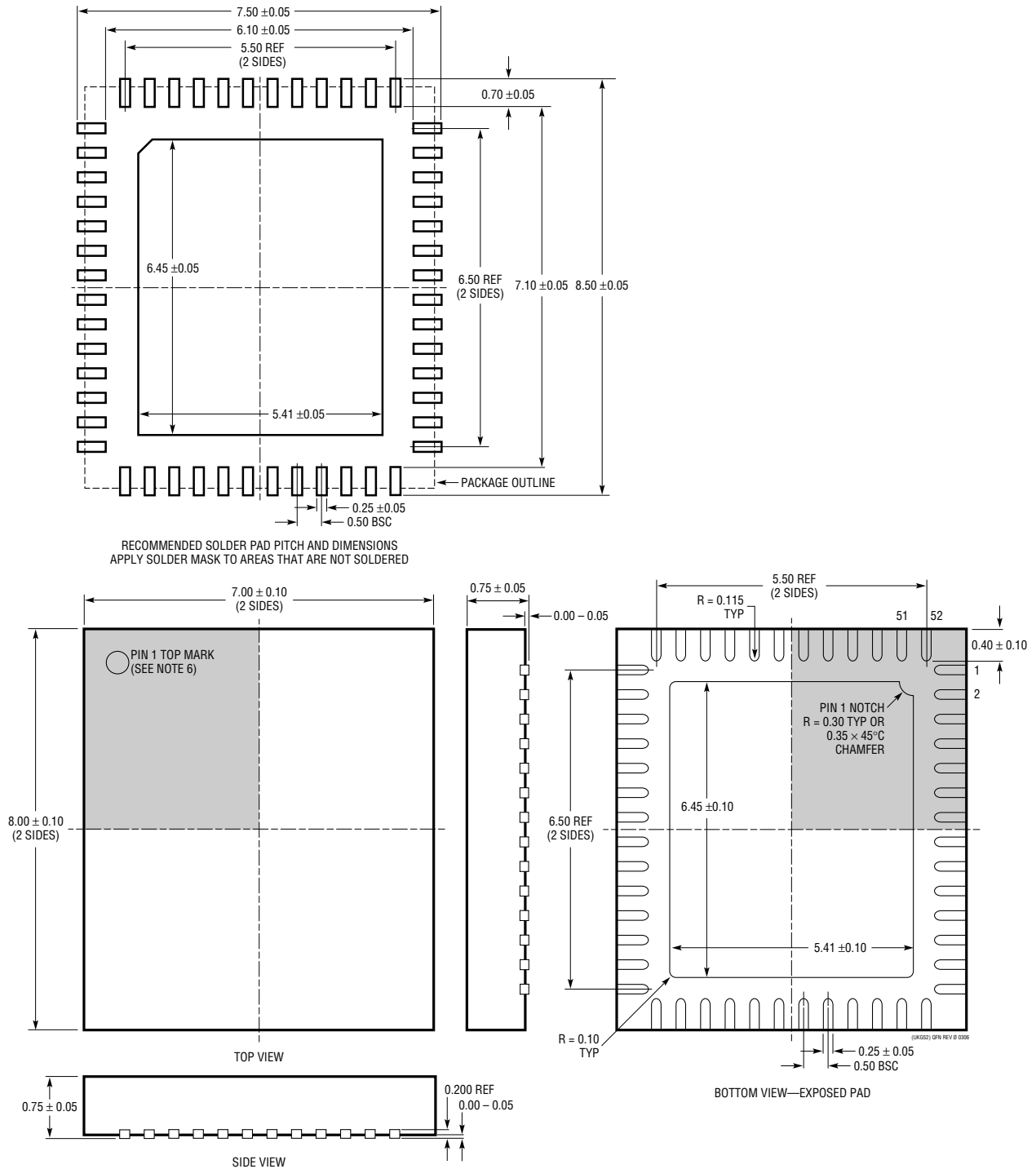

- NOTE:
- DRAWING IS NOT A JEDEC PACKAGE OUTLINE
 - DRAWING NOT TO SCALE
 - ALL DIMENSIONS ARE IN MILLIMETERS
 - DIMENSIONS OF EXPOSED PAD ON BOTTOM OF PACKAGE DO NOT INCLUDE MOLD FLASH. MOLD FLASH, IF PRESENT, SHALL NOT EXCEED 0.20mm ON ANY SIDE, IF PRESENT
 - EXPOSED PAD SHALL BE SOLDER PLATED
 - SHADED AREA IS ONLY A REFERENCE FOR PIN 1 LOCATION ON THE TOP AND BOTTOM OF PACKAGE

REVISION HISTORY

REV	DATE	DESCRIPTION	PAGE NUMBER
A	03/10	Changed Sampling Frequency Max for LTC2171-12 from 45MHz to 40MHz in the Timing Characteristics section	6
		Added full part numbers to Grounding and Bypassing and Heat Transfer sections in Applications Information	28
		Revised Descriptions and Comments in the Related Parts section	34

LTC2172-12/ LTC2171-12/LTC2170-12

RELATED PARTS

PART NUMBER	DESCRIPTION	COMMENTS
ADCs		
LTC2170-14/LTC2171-14/ LTC2172-14	14-Bit, 25Msps/40Msps/65Msps 1.8V Quad ADCs, Ultralow Power	162mW/202mW/311mW, 73.7dB SNR, 90dB SFDR, Serial LVDS Outputs, 7mm × 8mm QFN-52
LTC2173-14/LTC2174-14/ LTC2175-14	14-Bit, 80Msps/105Msps/125Msps 1.8V Quad ADCs, Ultralow Power	376mW/450mW/558mW, 73.4 dB SNR, 88dB SFDR, Serial LVDS Outputs, 7mm × 8mm QFN-52
LTC2173-12/LTC2174-12/ LTC2175-12	12-Bit, 80Msps/105Msps/125Msps 1.8V Quad ADCs, Ultralow Power	369mW/439mW/545mW, 70.6dB SNR, 88dB SFDR, Serial LVDS Outputs, 7mm × 8mm QFN-52
LTC2256-14/LTC2257-14/ LTC2258-14	14-Bit, 25Msps/40Msps/65Msps 1.8V ADCs, Ultralow Power	35mW/49mW/81mW, 74dB SNR, 88dB SFDR, DDR LVDS/DDR CMOS/CMOS Outputs, 6mm × 6mm QFN-40
LTC2259-14/LTC2260-14/ LTC2261-14	14-Bit, 80Msps/105Msps/125Msps 1.8V ADCs, Ultralow Power	89mW/106mW/127mW, 73.4dB SNR, 85dB SFDR, DDR LVDS/DDR CMOS/CMOS Outputs, 6mm × 6mm QFN-40
LTC2262-14	14-Bit, 150Msps 1.8V ADC, Ultralow Power	149mW, 72.8dB SNR, 88dB SFDR, DDR LVDS/DDR CMOS/CMOS Outputs, 6mm × 6mm QFN-40
LTC2263-14/LTC2264-14/ LTC2265-14	14-Bit, 25Msps/40Msps/65Msps 1.8V Dual ADCs, Ultralow Power	94mW/113mW/171mW, 73.7dB SNR, 90dB SFDR, Serial LVDS Outputs, 6mm × 6mm QFN-40
LTC2263-12/LTC2264-12/ LTC2265-12	12-Bit, 25Msps/40Msps/65Msps 1.8V Dual ADCs, Ultralow Power	94mW/112mW/167mW, 71dB SNR, 90dB SFDR, Serial LVDS Outputs, 6mm × 6mm QFN-40
LTC2266-14/LTC2267-14/ LTC2268-14	14-Bit, 80Msps/105Msps/125Msps 1.8V Dual ADCs, Ultralow Power	203mW/243mW/299mW, 73.1dB SNR, 88dB SFDR, Serial LVDS Outputs, 6mm × 6mm QFN-40
LTC2266-12/LTC2267-12/ LTC2268-12	12-Bit, 80Msps/105Msps/125Msps 1.8V Dual ADCs, Ultralow Power	200mW/238mW/292mW, 70.6dB SNR, 88dB SFDR, Serial LVDS Outputs, 6mm × 6mm QFN-40
RF Mixers/Demodulators		
LTC5517	400MHz to 900MHz Direct Conversion Quadrature Demodulator	High IIP3: 21dBm at 800MHz, Integrated LO Quadrature Generator
LTC5527	400MHz to 3.7GHz High Linearity Downconverting Mixer	24.5dBm IIP3 at 900MHz, 23.5dBm IIP3 at 1900MHz, NF = 12.5dB, 50Ω Single-Ended RF and LO Ports, 5V Supply
LTC5557	400MHz to 3.8GHz High Linearity Downconverting Mixer	24dBm IIP3 at 1950MHz, 23.7dBm IIP3 at 2.6GHz, NF = 13.2dB, 3.3V Supply Operation, Integrated Transformer
LTC5575	800MHz to 2.7GHz Direct Conversion Quadrature Demodulator	High IIP3: 28dBm at 900MHz, Integrated LO Quadrature Generator, Integrated RF and LO Transformer
Amplifiers/Filters		
LTC6412	800MHz, 31dB Range, Analog-Controlled Variable Gain Amplifier	Continuously Adjustable Gain Control, 35dBm OIP3 at 240MHz, 10dB Noise Figure, 4mm × 4mm QFN-24
LTC6420-20	Dual Low Noise, Low Distortion Differential ADC Drivers for 300MHz IF	Fixed Gain 10V/V, 2.2nV/√Hz Total Input Referred Noise, 80mA Supply Current per Amplifier, 46dBm OIP3 at 100MHz, 3mm × 4mm QFN-20
LTC6421-20	Dual Low Noise, Low Distortion Differential ADC Drivers for 140MHz IF	Fixed Gain 10V/V, 2.2nV/√Hz Total Input Referred Noise, 40mA Supply Current per Amplifier, 42dBm OIP3 at 100MHz, 3mm × 4mm QFN-20
LTC6605-7/ LTC6605-10/ LTC6605-14	Dual Matched 7MHz/10MHz/14MHz Filters with ADC Drivers	Dual Matched 2nd Order Lowpass Filters with Differential Drivers, Pin-Programmable Gain, 6mm × 3mm DFN-22
Signal Chain Receivers		
LTM9002	14-Bit Dual Channel IF/Baseband Receiver Subsystem	Integrated High Speed ADC, Passive Filters and Fixed Gain Differential Amplifiers

21721012fa