

PLEASE CHECK WWW.MOLEX.COM FOR LATEST PART INFORMATION

Part Number: [0901522140](#)
Status: **Active**
Overview: [cgrid_sl_products](#)
Description: 2.54mm (.100") Pitch C-Grid III™ PC Board Connector, Dual Row, Right Angle, Straight PCB Pins 1.0µm (40µ") Tin (Sn), 40 Circuits

Documents:

[3D Model](#) [RoHS Certificate of Compliance \(PDF\)](#)
[Drawing \(PDF\)](#)

General

Product Family	PCB Receptacles
Series	90152
Application	Board-to-Board
Overview	cgrid_sl_products
Product Name	C-Grid III™

Physical

Circuits (Loaded)	40
Color - Resin	Black
Glow-Wire Compliant	No
Guide to Mating Part	No
Keying to Mating Part	None
Lock to Mating Part	No
Material - Metal	Phosphor Bronze
Material - Plating Mating	Tin
Material - Plating Termination	Tin
Material - Resin	Polyester
Number of Rows	2
Orientation	Right Angle
PC Tail Length (in)	0.114 In
PC Tail Length (mm)	2.90 mm
PCB Locator	No
PCB Retention	None
PCB Thickness Recommended (in)	0.062 In
PCB Thickness Recommended (mm)	1.60 mm
Packaging Type	Tube
Pitch - Mating Interface (in)	0.100 In
Pitch - Mating Interface (mm)	2.54 mm
Plating min: Mating (µin)	40
Plating min: Mating (µm)	1.00
Plating min: Termination (µin)	40
Plating min: Termination (µm)	1.00
Polarized to PCB	No
Temperature Range - Operating	-55°C to +125°C
Termination Interface: Style	Through Hole

Electrical

Current - Maximum per Contact	3A
Grounding to PCB	No
Voltage - Maximum	350V

Solder Process Data

Lead-free Process Capability [Wave Capable \(TH only\)](#)

Material Info

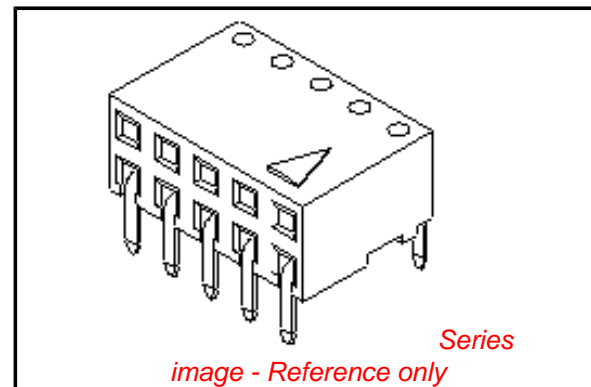

EU RoHS

**ELV and RoHS
Compliant**
**REACH SVHC
Contains SVHC: No**
**Halogen-Free
Status**

China RoHS



**Need more information on product
environmental compliance?**

Email productcompliance@molex.com
 For a multiple part number RoHS Certificate of Compliance, [click here](#)

Please visit the [Contact Us](#) section for any non-product compliance questions.

Search Parts in this Series

[90152Series](#)

Mates With

[90122](#) , [90131](#)

Reference - Drawing Numbers

Sales Drawing

SDA-90152

This document was generated on 05/24/2010

PLEASE CHECK WWW.MOLEX.COM FOR LATEST PART INFORMATION

TERMINAL RETENTION FEATURE



RECOMMENDED P.C. BOARD HOLE PATTERN

NOTES

- 1) CONTACT-PLATED PHOSPHOR BRONZE.
- 2) HOUSING-15% GLASS FILLED POLYESTER. COLOUR-BLACK.
- 3) COMPATABLE WITH PCB HOLE PATTERN.
- 4) THIS MARK INDICATES CIRCUIT NO.1.
- 5) FOR (0.635)/.025 SQ. MALE PINS THE LENGTH MUST BE (5.65)/.222 MIN & (7.00)/.276 MAX. TO ENSURE GOOD CONNECTION WITH CONTACT.
- 6) PRODUCT SPECIFICATION: PS-99020-0001
- 7) RECOMMENDED PCB THICKNESS 1.6MM



SEE DETAIL "A"

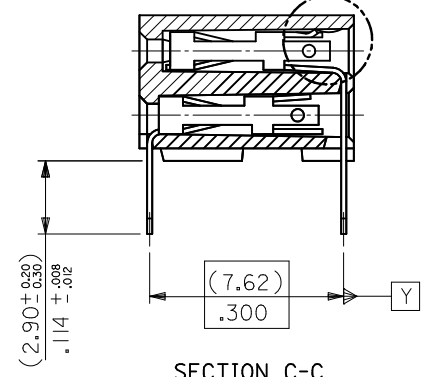

SECTION C-C

DETAIL "A"



TERMINAL RETENTION FEATURE

CHG PKG QTY FOR 4CKT EC NO: S2010-0556 DRWN:ATSEE 2010/01/12 CHKD:SKANG 2010/01/14 APPR:MLONG 2010/01/14	QUALITY SYMBOLS $F_{\Delta} = 0$ $F_{\square} = 0$ $F_{\nabla} = 0$	GENERAL TOLERANCES (UNLESS SPECIFIED)		DIMENSION STYLE MM ONLY		SCALE NTS	DESIGN UNITS METRIC	THIRD ANGLE PROJECTION	
		mm	INCH	DRAWN BY DB	DATE 1987/07/14	TITLE C-GRID PCB CONN DR HORZ			
B	REV	4 PLACES	± ---	± ---	CHECKED BY DB	DATE 1987/07/14	MOLEX INCORPORATED DOCUMENT NO. SDA-90152		
		3 PLACES	± ---	± ---	APPROVED BY MLONG	DATE 2010/01/14			
		2 PLACES	± 0.20	± .008	SHEET NO. 1 OF 5				
		1 PLACE	± ---	± ---					
		ANGULAR ± 2 °		MATERIAL NO. SEE TABLE		THIS DRAWING CONTAINS INFORMATION THAT IS PROPRIETARY TO MOLEX INCORPORATED AND SHOULD NOT BE USED WITHOUT WRITTEN PERMISSION			

	10	9	8	7	6	5	4	3	2	1	
	PART NO.	CKT	DIM. A		DIM. B ^(+0.00) _(-0.30) ^{+0.00} _{-0.12}		PCS/ TUBE				
F	90152-XX04	4	(2.54)	.100	(5.08)	.200	109	PLATING VERSION A			
	06	6	(5.08)	.200	(7.62)	.300	73	PRE-PLATED HOT DIP TIN 1.0 TO 2.5 microns (.00004" TO .00010").			
	08	8	(7.62)	.300	(10.16)	.400	55	PLATING VERSION E			
	10	10	(10.16)	.400	(12.70)	.500	44	1.27 TO 1.78 microns (.00005" TO .00007") NICKEL OVERALL, 0.38 TO 0.64 microns (.000015" TO .000025") GOLD ON CONTACT AREA (OVER NICKEL). 3 TO 5 microns (.00012" TO .00020") TIN ON SOLDER TAILS (OVER NICKEL).			
	12	12	(12.70)	.500	(15.24)	.600	36	PLATING VERSION F			
	14	14	(15.24)	.600	(17.78)	.700	31	1.27 TO 1.78 microns (.00005" TO .00007") NICKEL OVERALL, 0.76 TO 1.0 microns (.00003" TO .00004") GOLD ON CONTACT AREA (OVER NICKEL). 3 TO 5 microns (.00012" TO .00020") TIN ON SOLDER TAILS (OVER NICKEL).			
E	16	16	(17.78)	.700	(20.32)	.800	27	PLATING VERSION G			
	18	18	(20.32)	.800	(22.86)	.900	24	1.27 TO 1.78 microns (.00005" TO .00007") NICKEL OVERALL, 0.125 TO 0.20 microns (.000005" TO .0000079") GOLD ON CONTACT AREA (OVER NICKEL). 3 TO 5 microns (.00012" TO .00020") TIN ON SOLDER TAILS (OVER NICKEL).			
	20	20	(22.86)	.900	(25.40)	1.000	22	90152 - X X Y Y INDICATES NO. OF CIRCUITS			
	22	22					20	PLATING CODE. 21 = VERSION A 22 = VERSION E 23 = VERSION F 25 = VERSION G			
	24	24	(27.94)	1.100	(30.48)	1.200	18				
	26	26	(30.48)	1.200	(33.02)	1.300	16				
D	28	28					14				
	30	30	(35.56)	1.400	(38.10)	1.500	14				
	32	32					13				
	34	34	(40.64)	1.600	(43.18)	1.700	12				
	36	36	(43.18)	1.700	(45.72)	1.800	12				
	38	38	(45.72)	1.800	(48.26)	1.900	11				
	40	40	(48.26)	1.900	(50.80)	2.000	11				
	42	42					10				
	44	44	(53.34)	2.100	(55.88)	2.200	10				
	46	46					10				
C	48	48					9				
	50	50	(60.96)	2.400	(63.50)	2.500	8				
	52	52					8				
	54	54					8				
	56	56	(68.58)	2.700	(71.12)	2.800	7				
	58	58					7				
B	60	60	(73.66)	2.900	(76.20)	3.000	7				
	62	62					6				
	90152-XX64	64	(78.74)	3.100	(81.28)	3.200	5				

STANDARD PRODUCTS

CHG PKG QTY FOR 4CKT EC NO: S2010-0556 DRWN:ATSEE 2010/01/12 CHKD:SKANG 2010/01/14 APPR:MLONG 2010/01/14	QUALITY SYMBOLS	GENERAL TOLERANCES (UNLESS SPECIFIED)	DIMENSION STYLE	SCALE	DESIGN UNITS	THIRD ANGLE PROJECTION															
	$\nabla_A = 0$ $\nabla_C = 0$ $\nabla_P = 0$	<table border="1"> <tr> <th></th> <th>mm</th> <th>INCH</th> </tr> <tr> <td>4 PLACES</td> <td>± ---</td> <td>± ---</td> </tr> <tr> <td>3 PLACES</td> <td>± ---</td> <td>± ---</td> </tr> <tr> <td>2 PLACES</td> <td>± 0.20</td> <td>± .008</td> </tr> <tr> <td>1 PLACE</td> <td>± ---</td> <td>± ---</td> </tr> </table>		mm	INCH	4 PLACES	± ---	± ---	3 PLACES	± ---	± ---	2 PLACES	± 0.20	± .008	1 PLACE	± ---	± ---	MM ONLY	NTS	METRIC	
		mm	INCH																		
	4 PLACES	± ---	± ---																		
3 PLACES	± ---	± ---																			
2 PLACES	± 0.20	± .008																			
1 PLACE	± ---	± ---																			
DESCRIPTION	ANGULAR ± 2 °	DRAWN BY: DB DATE: 1987/07/14 CHECKED BY: DB DATE: 1987/07/14 APPROVED BY: MLONG DATE: 2010/01/14	TITLE	C-GRID PCB CONN DR HORZ																	
REV	DRAFT WHERE APPLICABLE MUST REMAIN WITHIN DIMENSIONS	SEE TABLE	MATERIAL NO.	DOCUMENT NO.	MOLEX INCORPORATED SDA-90152																
			SIZE: A3	THIS DRAWING CONTAINS INFORMATION THAT IS PROPRIETARY TO MOLEX INCORPORATED AND SHOULD NOT BE USED WITHOUT WRITTEN PERMISSION																	



10 9 8 7 6 5 4 3 2 1

TERMINAL RETENTION FEATURE

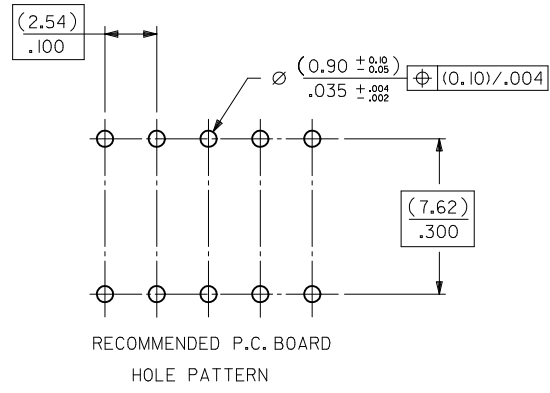
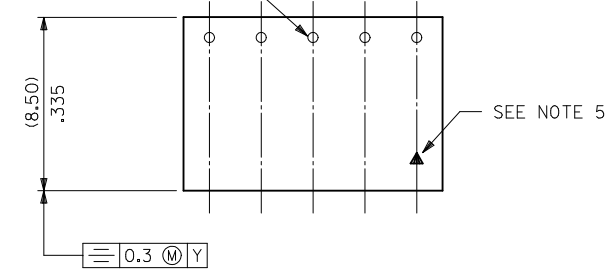

RECOMMENDED P.C. BOARD HOLE PATTERN

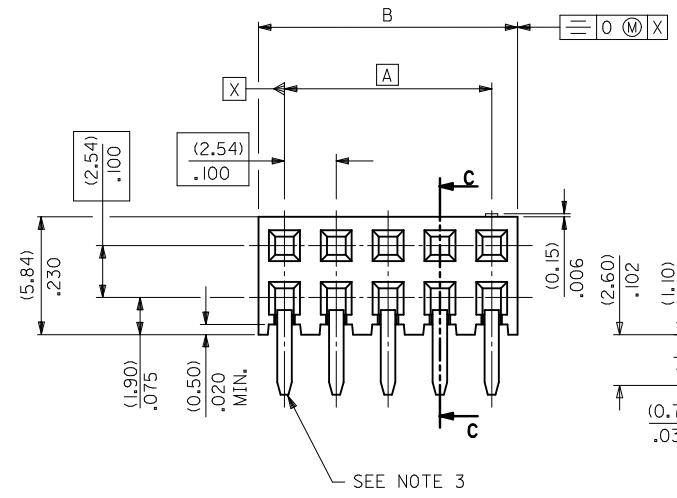

(0 M) X

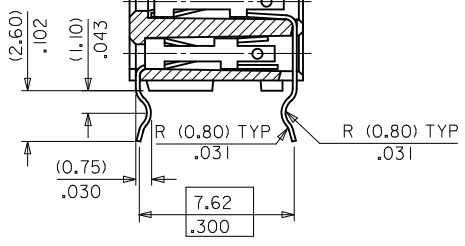

SECTION C-C

NOTES

- 1) CONTACT-PLATED PHOSPHOR BRONZE.
- 2) HOUSING-15% GLASS FILLED POLYESTER, COLOUR-BLACK.
- 3) COMPATIBLE WITH PCB HOLE PATTERN.
- 4) RECOMMENDED PC BOARD THICKNESS (1.4 ± .2) / .055 ± .008
- 5) THIS MARK INDICATES CIRCUIT NO.1.
- 6) FOR (0.635) / .025 SO. MALE PINS THE LENGTH MUST BE (5.65) / .222 MIN & (7.00) / .276 MAX. TO ENSURE GOOD CONNECTION WITH CONTACT.

DETAIL *A*

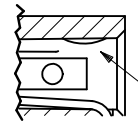

TERMINAL RETENTION FEATURE

CHG PKG QTY FOR 4CKT EC NO: S2010-0556 DRAWN/AT/SEE 2010/01/12 CHKD/SKANG 2010/01/14 APPR/MLONG 2010/01/14	QUALITY SYMBOLS	GENERAL TOLERANCES (UNLESS SPECIFIED)	DIMENSION STYLE	SCALE	DESIGN UNITS	THIRD ANGLE PROJECTION
	▽=0	mm INCH	MM ONLY	NTS	METRIC	⊙
	▽=0	4 PLACES ± --- ± ---	DRAWN BY DATE			
	▽=0	3 PLACES ± --- ± ---	DB 1987/07/14	TITLE		

2 PLACES ± 0.20 ± .008	CHECKED BY DATE		
1 PLACE ± --- ± ---	DB 1987/07/14		
ANGULAR ± 2 °	APPROVED BY DATE		
	MLONG 2010/01/14		

DRAFT WHERE APPLICABLE MUST REMAIN WITHIN DIMENSIONS	SIZE	SEE TABLE
	A 3	

C-GRID PCB CONN DR HORZ	
MOLEX INCORPORATED	
DOCUMENT NO.	SDA-90152
SHEET NO.	3 OF 5

9 8 7 6 5 4 3 2 1

	10	9	8	7	6	5	4	3	2	1
	PART NO.	CKT	DIM. A		DIM. B ^(+0.00) _(-0.30) ^{+0.00} _{-0.12}		PCS/ TUBE			
F	90152-XX04	4	(2.54)	.100	(5.08)	.200	109			
	06	6	(5.08)	.200	(7.62)	.300	73			
	08	8	(7.62)	.300	(10.16)	.400	55			
	10	10	(10.16)	.400	(12.70)	.500	44			
	12	12	(12.70)	.500	(15.24)	.600	36			
	14	14	(15.24)	.600	(17.78)	.700	31			
	16	16	(17.78)	.700	(20.32)	.800	27			
	18	18	(20.32)	.800	(22.86)	.900	24			
E	20	20	(22.86)	.900	(25.40)	1.000	22			
	22	22					20			
	24	24	(27.94)	1.100	(30.48)	1.200	18			
	26	26	(30.48)	1.200	(33.02)	1.300	16			
	28	28					14			
	30	30	(35.56)	1.400	(38.10)	1.500	14			
	32	32					13			
	34	34	(40.64)	1.600	(43.18)	1.700	12			
D	36	36	(43.18)	1.700	(45.72)	1.800	12			
	38	38	(45.72)	1.800	(48.26)	1.900	11			
	40	40	(48.26)	1.900	(50.80)	2.000	11			
	42	42					10			
	44	44	(53.34)	2.100	(55.88)	2.200	10			
	46	46					10			
	48	48					9			
	50	50	(60.96)	2.400	(63.50)	2.500	8			
C	52	52					8			
	54	54					8			
	56	56	(68.58)	2.700	(71.12)	2.800	7			
	58	58					7			
	60	60	(73.66)	2.900	(76.20)	3.000	7			
	62	62					6			
B	90152-XX64	64	(78.74)	3.100	(81.28)	3.200	5			

PLATING VERSION A

PRE-PLATED HOT DIP TIN
1.0 TO 2.5 microns (.00004" TO .00010").

PLATING VERSION E

1.27 TO 1.78 microns (.00005" TO .00007") NICKEL
OVERALL, 0.38 TO 0.64 microns (.000015" TO .000025")
GOLD ON CONTACT AREA (OVER NICKEL).
3 TO 5 microns (.00012" TO .00020") TIN
ON SOLDER TAILS (OVER NICKEL).

PLATING VERSION F.

1.27 TO 1.78 microns (.00005" TO .00007") NICKEL
OVERALL, 0.76 TO 1.0 microns (.00003" TO .00004")
GOLD ON CONTACT AREA (OVER NICKEL).
3 TO 5 microns (.00012" TO .00020") TIN
ON SOLDER TAILS (OVER NICKEL).

PLATING VERSION G.

1.27 TO 1.78 microns (.00005" TO .00007") NICKEL
OVERALL, 0.125 TO 0.20 microns (.000005" TO .0000079")
GOLD ON CONTACT AREA (OVER NICKEL).
3 TO 5 microns (.00012" TO .00020") TIN
ON SOLDER TAILS (OVER NICKEL).

90152-XXYY

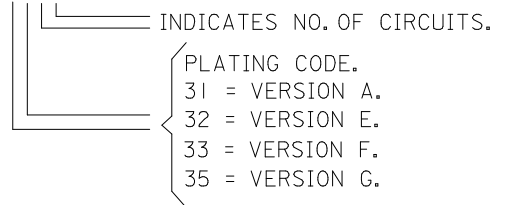

A	CHG PKG QTY FOR 4CKT EC NO: S2010-0556 DRWN:ATSEE 2010/01/12 CHKD:SKANG 2010/01/14 APPR:MLONG 2010/01/14	REV	DESCRIPTION	QUALITY SYMBOLS	GENERAL TOLERANCES (UNLESS SPECIFIED)	DIMENSION STYLE	SCALE	DESIGN UNITS	THIRD ANGLE PROJECTION
				$\nabla_A=0$	mm INCH	MM ONLY	NTS	METRIC	
				$\nabla_C=0$	4 PLACES ± --- ± ---	DRAWN BY DATE			C-GRID PCB CONN DR HORZ
				$\nabla_P=0$	3 PLACES ± --- ± ---	DB 1987/07/14			
	2 PLACES ± 0.20 ± .008	CHECKED BY DATE			MOLEX INCORPORATED				
	1 PLACE ± --- ± ---	DB 1987/07/14							
	ANGULAR ± 2 °	APPROVED BY DATE			SDA-90152				
		MLONG 2010/01/14							
	DRAFT WHERE APPLICABLE MUST REMAIN WITHIN DIMENSIONS	MATERIAL NO.			SHEET NO.				
		SEE TABLE			4 OF 5				
		SIZE A3							
		THIS DRAWING CONTAINS INFORMATION THAT IS PROPRIETARY TO MOLEX INCORPORATED AND SHOULD NOT BE USED WITHOUT WRITTEN PERMISSION							

PART NUMBER	CKT. SIZE	PIN VOID	KINKED PINS	NO. PER TUBE
90152-6234	2 X 17	21	NONE	12
90152-5242	2 X 21	5	NONE	10
90152-7130	2 X 15	NONE	1,2 & 29,30	14

TERMINAL RETENTION FEATURE

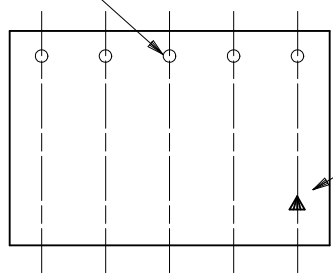

SEE NOTE 2.

NOTES

- 1) FOR DIMENSIONS SEE SHEET 1.
- 2) THIS MARK INDICATES CIRCUIT NO.1.
- 3) SOLDER TAIL OF TERMINAL IN VOIDED CAVITY MUST BE CROPPED AS SHOWN OR TERMINAL REMOVED.

90152-XXYY

INDICATES NO. OF CIRCUITS.
 PLATING CODE.
 1 = VERSION A.
 2 = VERSION E.
 3 = VERSION F.
 5 = VERSION G.

OPTIONS
 2 = REGULAR
 3 = KINKED
 5 = VOIDS
 6 = KINKS & VOIDS
 7 = SELECTIVE KINKS

SEE DETAIL "A"



SECTION C-C

DETAIL "A"



TERMINAL RETENTION FEATURE

CHG PKG QTY FOR 4CKT EC NO: S2010-0556 DRWN:ATSEE 2010/01/12 CHKD:SKANG 2010/01/14 APPR:MLONG 2010/01/14	DESCRIPTION REV	QUALITY SYMBOLS	GENERAL TOLERANCES (UNLESS SPECIFIED)	DIMENSION STYLE	SCALE	DESIGN UNITS	THIRD ANGLE PROJECTION
		$F_A=0$ $F_C=0$ $F_P=0$	mm INCH 4 PLACES ± --- ± --- 3 PLACES ± --- ± --- 2 PLACES ± 0.20 ± .008 1 PLACE ± --- ± --- ANGULAR ± 2 °	MM ONLY	NTS	METRIC	
				DRAWN BY: DB DATE: 1987/07/14	TITLE: C-GRID PCB CONN DR HORZ		
				CHECKED BY: DB DATE: 1987/07/14	MOLEX INCORPORATED		
				APPROVED BY: MLONG DATE: 2010/01/14	DOCUMENT NO. SDA-90152		
				MATERIAL NO. SEE TABLE	SHEET NO. 5 OF 5		
				SIZE: A3	THIS DRAWING CONTAINS INFORMATION THAT IS PROPRIETARY TO MOLEX INCORPORATED AND SHOULD NOT BE USED WITHOUT WRITTEN PERMISSION		

SEE CHART
PART NO. SDA-90152
DWG. NO.

PART NO.	NO. OF CKTS.	DIM. A		DIM. B $\begin{matrix} (+0.00 \\ 0.30 \\ +.000 \\ -.012 \end{matrix}$		NO. PER TUBE
90152-XX04	4	(2.54)	.100	(5.08)	.200	110
▲ ▲ 06	6	(5.08)	.200	(7.62)	.300	73
08	8	(7.62)	.300	(10.16)	.400	55
10	10	(10.16)	.400	(12.70)	.500	44
12	12	(12.70)	.500	(15.24)	.600	36
14	14	(15.24)	.600	(17.78)	.700	31
16	16	(17.78)	.700	(20.32)	.800	27
18	18	(20.32)	.800	(22.86)	.900	24
20	20	(22.86)	.900	(25.40)	1.000	22
22	22					20
24	24	(27.94)	1.100	(30.48)	1.200	18
26	26	(30.48)	1.200	(33.02)	1.300	16
28	28					14
30	30	(35.56)	1.400	(38.10)	1.500	14
32	32					13
34	34	(40.64)	1.600	(43.18)	1.700	12
36	36	(43.18)	1.700	(45.72)	1.800	12
38	38	(45.72)	1.800	(48.26)	1.900	11
40	40	(48.26)	1.900	(50.80)	2.000	11
42	42					10
44	44	(53.34)	2.100	(55.88)	2.200	10
46	46					10
48	48					9
50	50	(60.96)	2.400	(63.50)	2.500	8
52	52					8
54	54					8
56	56	(68.58)	2.700	(71.12)	2.800	7
58	58					7
60	60	(73.66)	2.900	(76.20)	3.000	7
▼ ▼ 62	62					6
90152-XX64	64	(78.74)	3.100	(81.28)	3.200	5

PLATING VERSION A

PRE-PLATED HOT DIP TIN
1.0 TO 2.5 microns (.00004" TO .00010").

PLATING VERSION E

1.27 TO 1.78 microns (.00005" TO .00007") NICKEL
OVERALL, 0.38 TO 0.64 microns (.000015" TO .000025")
GOLD ON CONTACT AREA (OVER NICKEL).
3 TO 5 microns (.00012" TO .00020") TIN
ON SOLDER TAILS (OVER NICKEL).

PLATING VERSION F.

1.27 TO 1.78 microns (.00005" TO .00007") NICKEL
OVERALL, 0.76 TO 1.0 microns (.00003" TO .00004")
GOLD ON CONTACT AREA (OVER NICKEL).
3 TO 5 microns (.00012" TO .00020") TIN
ON SOLDER TAILS (OVER NICKEL).

PLATING VERSION G.

1.27 TO 1.78 microns (.00005" TO .00007") NICKEL
OVERALL, 0.125 TO 0.20 microns (.000005" TO .0000079")
GOLD ON CONTACT AREA (OVER NICKEL).
3 TO 5 microns (.00012" TO .00020") TIN
ON SOLDER TAILS (OVER NICKEL).

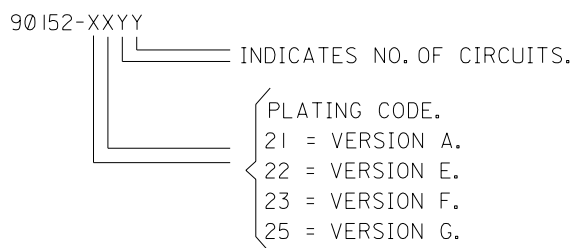

STANDARD PRODUCTS

FOR PREVIOUS DRAWING ISSUES SEE MRI.

LEAD FREE CONVERSION NEW BORDER ADDED EC NO. E2004-0610 DRWN: PSHEAHAN 08/01/2004 CHK: APPR:	QUALITY SYMBOLS MAJOR CRITICAL	GENERAL TOLERANCES: (UNLESS SPECIFIED)		SCALE 5:1	DESIGN UNITS <input checked="" type="checkbox"/> mm <input type="checkbox"/> INCH	THIRD ANGLE PROJECTION	DIMENSIONS: <input type="checkbox"/> mm <input type="checkbox"/> INCH <input type="checkbox"/> mm ONLY	SHT	REV
		4 PLACES ±0. ±.	3 PLACES ±0. ±.	2 PLACES ±0. ±.	1 PLACE ±0. ±.	ANGULAR: ± °	DRAWN BY & DATE DB 14/ 7/87		CHECKED BY & DATE
AD	REV	DESCRIPTION	DRAFT WHERE APPLICABLE MUST REMAIN WITHIN DIMENSIONS		APPROVED BY & DATE	TITLE: C-GRID III DUAL ROW HORIZONTAL P.C. BOARD CONNECTOR		MOLEX INCORPORATED	
			THIS DRAWING CONTAINS INFORMATION THAT IS PROPRIETARY TO MOLEX INCORPORATED AND SHOULD NOT BE USED WITHOUT WRITTEN PERMISSION.		CAD FILENAME 590152x2 DGN	MATERIAL NO. SEE CHART	DRAWING NO. SDA-90152	SHEET NO. 20F	SIZE B