

PLEASE CHECK WWW.MOLEX.COM FOR LATEST PART INFORMATION

Part Number: **0340620006**
Status: **Active**
Overview: mx150
Description: 5.00mm (.197") Pitch MX150™ Cable Sealed Female Connector, Single Row, 2 Circuits, Polarization B, with Connector Position Assurance, Gray

Documents:

[Application Specification \(PDF\)](#) [Product Specification PS-34062-000 \(PDF\)](#)
[Drawing \(PDF\)](#) [RoHS Certificate of Compliance \(PDF\)](#)

General

Product Family	Crimp Housings
Series	<u>34062</u>
Comments	With Connector Position Assurance (CPA)
MolexKits	Yes
More Detailed Tech Information	http://ewcap.uscarteams.org
Overview	<u>mx150</u>
Product Name	MX150™

Physical

Circuits (maximum)	2
Circuits Detail	2
Color - Resin	Gray
Gender	Female
Glow-Wire Compliant	No
Keying to Mating Part	Yes
Lock to Mating Part	Yes
Material - Resin	Nylon
Number of Rows	1
Packaging Type	Bag
Panel Mount	No
Pitch - Mating Interface (in)	0.197 In
Pitch - Mating Interface (mm)	5.00 mm
Pitch - Term. Interface (in)	0.197 In
Pitch - Term. Interface (mm)	5.00 mm
Polarized to Mating Part	Yes
Stackable	No
Temperature Range - Operating	-40°C to +125°C

Electrical

Current - Maximum per Contact	15A
-------------------------------	-----

Material Info

Reference - Drawing Numbers

Packaging Specification	PK-30907-879
Product Specification	PS-34062-000
Sales Drawing	SD-34062-001



EU RoHS

ELV and RoHS Compliant
REACH SVHC
 Not Reviewed
Halogen-Free Status
 Not Reviewed

China RoHS



Need more information on product environmental compliance?

Email productcompliance@molex.com
 For a multiple part number RoHS Certificate of Compliance, [click here](#)

Please visit the [Contact Us](#) section for any non-product compliance questions.

Search Parts in this Series

34062Series

Mates With

Direct Connect only

Use With

34083 Tin (Sn) Cable Seal Female Terminal,
34081 Gold (Au) Cable Seal Female Terminal

ASSEMBLY PART NUMBER	COLOR	KEYING OPTION	CPA	CLIPSLOT	TOOLED
34062-0001	BLACK	A	NO	NO	YES
34062-0002	GRAY	B	NO	NO	YES
34062-0003	BLACK	C	NO	NO	YES
34062-0004	BLACK	D	NO	NO	YES
34062-0005	BLACK	A	YES	NO	YES
34062-0006	GRAY	B	YES	NO	YES
34062-0007	BLACK	C	YES	NO	YES
34062-0008	BLACK	D	YES	NO	YES
34062-0009	GRAY	D	NO	NO	YES
34062-0010	GRAY	D	YES	NO	YES
34062-0011	BLACK	A	NO	YES	YES
34062-0012	GRAY	B	NO	YES	NO
34062-0013	BLACK	C	NO	YES	NO
34062-0014	BLACK	D	NO	YES	NO
34062-0015	BLACK	A	YES	YES	YES
34062-0016	GRAY	B	YES	YES	NO
34062-0017	BLACK	C	YES	YES	NO
34062-0018	BLACK	D	YES	YES	NO
34062-0019	GRAY	D	NO	YES	NO
34062-0020	GRAY	D	YES	YES	NO

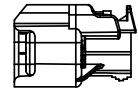
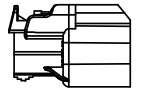
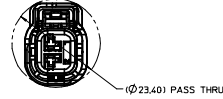
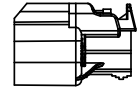
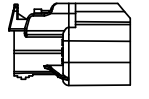
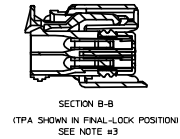
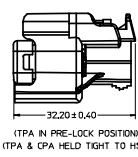
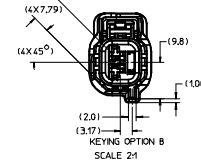
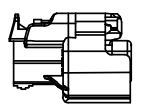
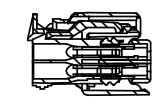
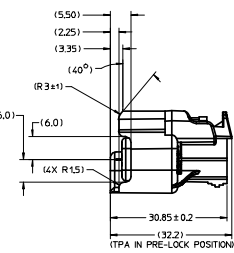
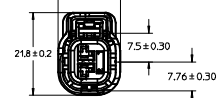
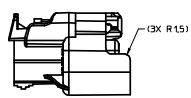
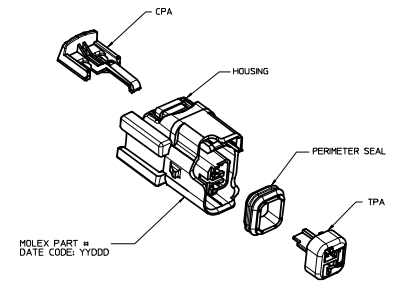
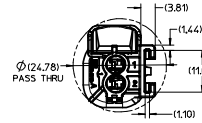
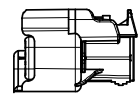
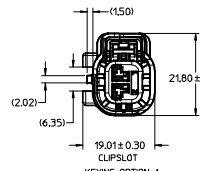
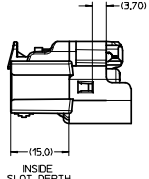
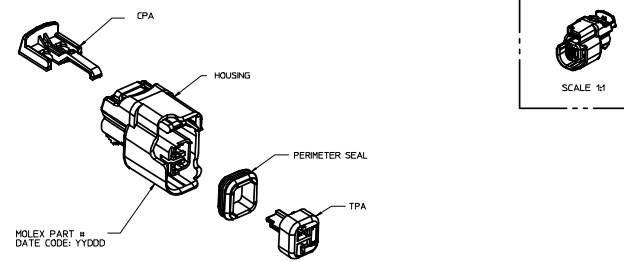
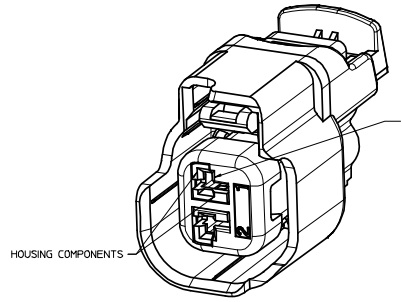
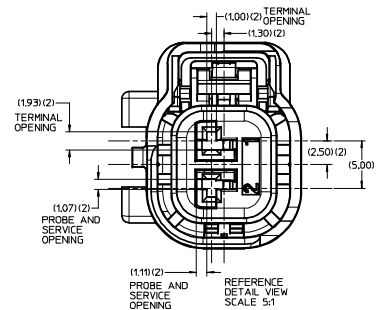

- NOTES: UNLESS OTHERWISE SPECIFIED
- ASSEMBLY CONFORMS TO:
SAE/USCAR-12, REV 2.
SAE/USCAR-2, REV 4.
EXCEPT TPA REMOVAL FROM FINAL LOCK - SECOND CYCLE.
SHALL NOT BE LESS THAN 12 NEWTONS
SAE/USCAR-20 DEC. 2001.
 - DESIGNED TO MATE WITH DEVICE CONNECTION AS SPECIFIED IN EWCAP DRAWING 550-5-002-1-201 REV A 19-18-2003.
 - ASSEMBLY SHIPPED WITH TPA IN PRE-LOCK POSITION (SEE SECTION B-B PRE-LOCK). UPON FULL TERMINAL ASSEMBLY, EACH TPA MUST BE SNAPPED INTO ITS FINAL-LOCK POSITION.
 - OPTIONAL CPA SHOWN IN ALL VIEWS. SEE TABLES FOR SPECIFIC ASSEMBLY OPTION AND NUMBER.
 - KEYING OPTION AND ASSEMBLY MACHINE IDENTIFIER.
 - RECYCLE CODE FOR PERIMETER SEAL: SILICON 50 DUROMETER
HOUSING: PPE/PA-GF30
TPA/CPA: PBT-GF30
 - SYSTEM TESTED USING ESB-HL123-A, 16/18, 20/22 AWG WIRE. MS-8288 AND MS9502 ARE ACCEPTABLE ALTERNATIVES.

22	0.50	34083-2003	34083-0003	RIGHT	TIN	22	7158-3030-50	120-170	RED	E-1644-01	119-165	PINK
22	0.50	34083-3003	34083-1003	LEFT	TIN	22	7158-3030-50	120-170	RED	E-1644-01	119-165	
22	0.50	34081-2005	34081-0005	RIGHT	GOLD	22	7158-3030-50	120-170	RED	E-1644-01	119-165	
22	0.50	34081-3005	34081-1005	LEFT	GOLD	22	7158-3030-50	120-170	RED	E-1644-01	119-165	
20	0.75	34083-2002	34083-0002	RIGHT	TIN	18/20	7158-3031-90	163-2.40	BLUE	E-1644-00	160-210	GREEN
20	0.75	34083-3002	34083-1002	LEFT	TIN	18/20	7158-3031-90	163-2.40	BLUE	E-1644-00	160-210	
20	0.75	34081-2004	34081-0004	RIGHT	GOLD	18/20	7158-3031-90	163-2.40	BLUE	E-1644-00	160-210	
20	0.75	34081-3004	34081-1004	LEFT	GOLD	18/20	7158-3031-90	163-2.40	BLUE	E-1644-00	160-210	
18	1.0	34083-2002	34083-0002	RIGHT	TIN	18/20	7158-3031-90	163-2.40	BLUE	E-1644-00	160-210	GREEN
18	1.0	34083-3002	34083-1002	LEFT	TIN	18/20	7158-3031-90	163-2.40	BLUE	E-1644-00	160-210	
18	1.0	34081-2004	34081-0004	RIGHT	GOLD	18/20	7158-3031-90	163-2.40	BLUE	E-1644-00	160-210	
18	1.0	34081-3004	34081-1004	LEFT	GOLD	18/20	7158-3031-90	163-2.40	BLUE	E-1644-00	160-210	
16	1.5	34083-2001	34083-0001	RIGHT	TIN	14/16	7158-3031-90	163-2.40	BLUE	E-1644-02	210-250	YELLOW
16	1.5	34083-3001	34083-1001	LEFT	TIN	14/16	7158-3031-90	163-2.40	BLUE	E-1644-02	210-250	
16	1.5	34081-2003	34081-0003	RIGHT	GOLD	16	7158-3031-90	163-2.40	BLUE	E-1644-02	210-250	
16	1.5	34081-3003	34081-1003	LEFT	GOLD	16	7158-3031-90	163-2.40	BLUE	E-1644-02	210-250	
AWG	METRIC						YAZAKI P/N	WIRE OD RANGE	COLOR	OSR P/N	WIRE OD RANGE	COLOR
WIRE SIZE	PREFERRED TERMINAL	OPTIONAL TERMINAL	PAYOFF DIRECTION	PLATING	GRP		YAZAKI			OSR		
			TERMINAL								CABLE SEAL	

ENTER DESCRIPTION EC NO. UAU2008-063Z DRAWING/REVISION/DATE/APP. 3/2003/06/08 APPROVED BY: 2003/04/08	QUALITY SYMBOLS 0 0	GENERAL TOLERANCES (UNLESS SPECIFIED) mm INCH		DIMENSION STYLE MM ONLY		SCALE	DESIGN UNITS	THIRD ANGLE PROJECTION
		4 PLACES ± --- ± --- 3 PLACES ± --- ± --- 2 PLACES ± 0.10 ± --- 1 PLACE ± 0.3 ± ---	ANGULAR ± 3°	DRAWN BY DATE L.P.LIM 2002/11/15	CHECKED BY DATE DKOEHLER 2002/11/25	TITLE CONNECTOR ASSEMBLY 2-WAY FUEL 15MM FEMALE FUEL INJECTOR CONNECTOR	MATERIAL NO. SEE TABLE	DOCUMENT NO. SD-34062-001
DRAFT WHERE APPLICABLE MUST REMAIN WITHIN DIMENSIONS		THIS DRAWING CONTAINS INFORMATION THAT IS PROPRIETARY TO MOLEX INCORPORATED AND SHOULD NOT BE USED WITHOUT WRITTEN PERMISSION						