



CHENMKO ENTERPRISE CO.,LTD

Lead free devices

**SURFACE MOUNT
SWITCHING DIODE**

VOLTAGE 80 Volts CURRENT 0.1 Ampere

CH228UPT

APPLICATION

- * Bias circuit.
- * Protection circuits.

FEATURE

- * Small surface mounting type. (SC-70/SOT-323)
- * Two diode elements are connected in series (VFX2) per circuit.
- * Maximum total power dissipation is 200mW.
- * Peak forward current is 200mA.

CONSTRUCTION

- * Silicon epitaxial planar

MARKING

- * A7

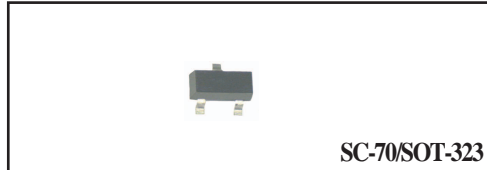

SC-70/SOT-323

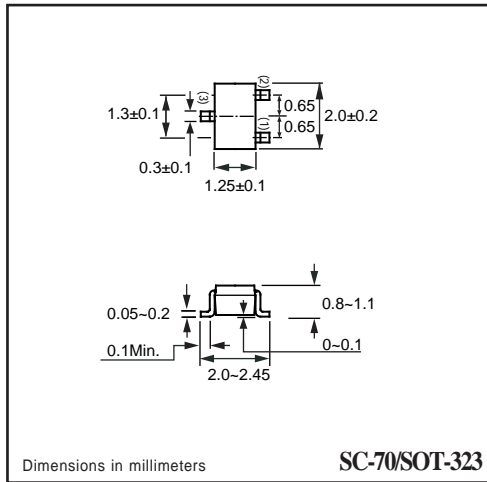

CIRCUIT

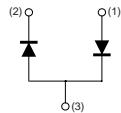

MAXIMUM RATINGS (At TA = 25°C unless otherwise noted)

RATINGS	SYMBOL	CH228UPT	UNITS
Maximum Recurrent Peak Reverse Voltage	VRRM	80	Volts
Maximum RMS Voltage	VRMS	56	Volts
Maximum DC Blocking Voltage	VDC	80	Volts
Maximum Average Forward Rectified Current	IO	0.1	Amps
Peak Forward Surge Current at 1uSec.	IFSM	0.3	Amps
Typical Junction Capacitance between Terminal (Note 1)	CJ	2.0	pF
Maximum Operating Temperature Range	TJ	+150	°C
Storage Temperature Range	TSTG	-55 to +150	°C

ELECTRICAL CHARACTERISTICS (At TA = 25°C unless otherwise noted)

CHARACTERISTICS	SYMBOL	CH228UPT	UNITS
Maximum Instantaneous Forward Voltage at IF= 100mA	VF	1.20	Volts
Maximum Average Reverse Current at VR= 80V	IR	0.1	uAmps

NOTES : 1. Measured at 1.0 MHz and applied reverse voltage of 6.0 volts.
2. ESD sensitive product handling required.

RATING CHARACTERISTIC CURVES (CH228UPT)

FIG. 1 - FORWARD CHARACTERISTICS

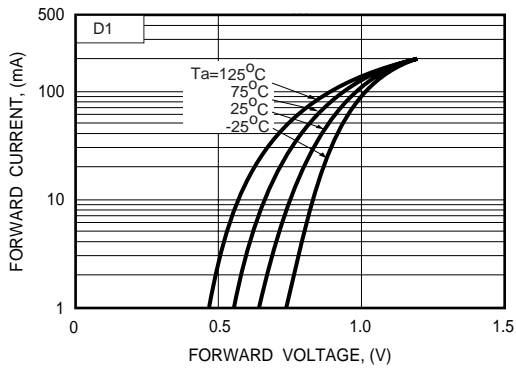

FIG. 2 - FORWARD CHARACTERISTICS

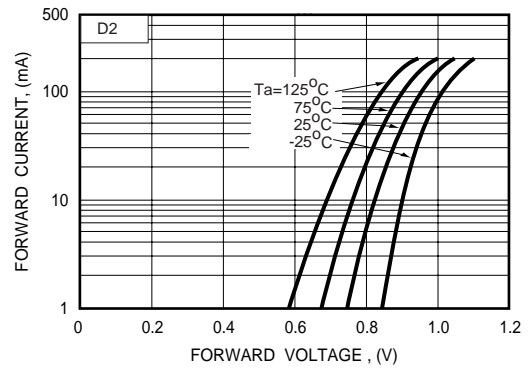

FIG. 3 - REVERSE CHARACTERISTICS

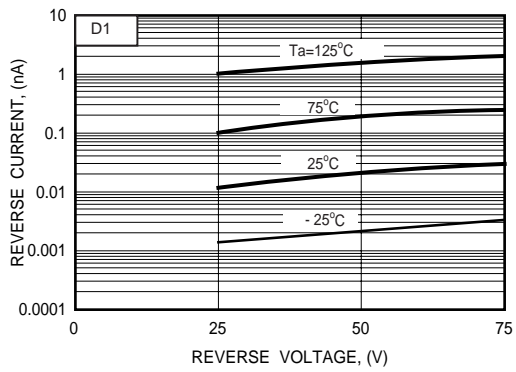

FIG. 4 - REVERSE CHARACTERISTICS

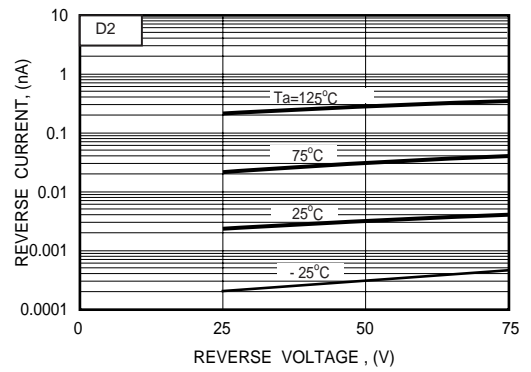

FIG. 5 - TYPICAL JUNCTION CAPACITANCE

