

# T-1 3/4 PACKAGE SOLID STATE LAMP

MVL-591HG

## Description

The MVL-591HG LED lamp is made with Gallium Phosphide on Gallium Phosphide.  
The package is a custom 10.2 mm part for System Sensor.  
The part has green diffused lens and a wide viewing angle.

## Features

- Customer 10.2 mm lens for System Sensor
- Low power consumption

## Package Dimensions

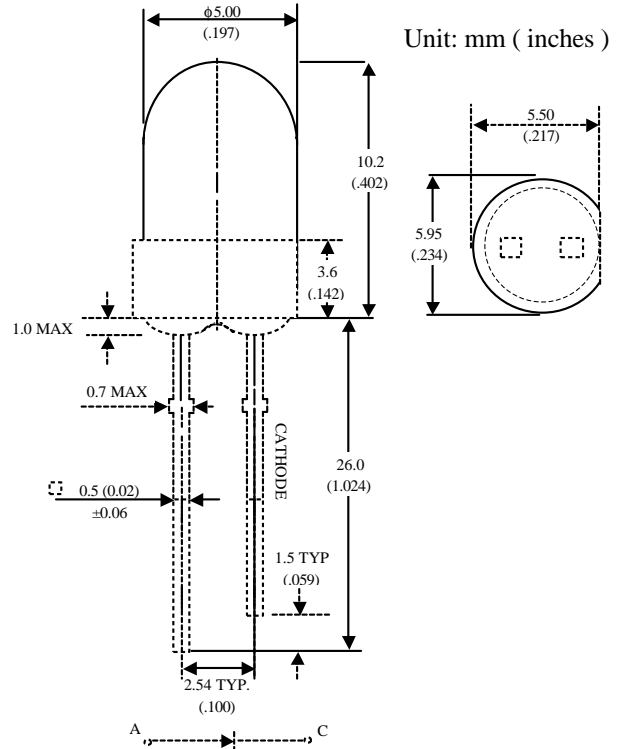

Notes :

1. Tolerance is  $\pm 0.25$  mm (.010" ) unless otherwise noted.
2. Protruded resin under flange is 1.0 mm (.040") max.
3. Lead spacing is measured where the leads emerge from the package.

## Absolute Maximum Ratings :

@  $T_A = 25^\circ\text{C}$

Parameter	Symbol	Maximum Rating	Unit
Power Dissipation	$P_{ad}$	100	mW
Peak Forward Current(1/10 Duty Cycle 0.1 ms pulse width)	$I_{pf}$	120	mA
Continuous Forward Current	$I_{af}$	30	mA
Derating Linear From 25°C		0.4	mA/°C
Reverse Voltage	$V_R$	5	V
Operating Temperature Range	$T_{opr}$	-55°C to +100°C	
Storage Temperature Range	$T_{stg}$	-55°C to +100°C	
Lead Soldering Temperature (1.6 mm from body) for 3 seconds at 260°C			

## Optical-Electrical Characteristics

@ T<sub>A</sub>=25°C

Parameter	Test Conditions	Symbol	Min .	Typ .	Max .	Unit .
Luminous Intensity	I <sub>F</sub> =10mA	I <sub>V</sub>	15	25	-	mcd
Forward Voltage	I <sub>F</sub> =20mA	V <sub>F</sub>	-	2.1	2.8	V
Reverse Current	V <sub>R</sub> =5V	I <sub>R</sub>	-	-	100	μA
Peak Emission Wavelength	I <sub>F</sub> =20mA	λ <sub>p</sub>	-	565	-	nm
Spectral Line Half Width	I <sub>F</sub> =20mA	Δλ	-	30	-	nm
Viewing Angle	I <sub>F</sub> =20mA	2θ <sub>1/2</sub>	-	55	-	deg.

## Typical Optical-Electrical Characteristic Curves

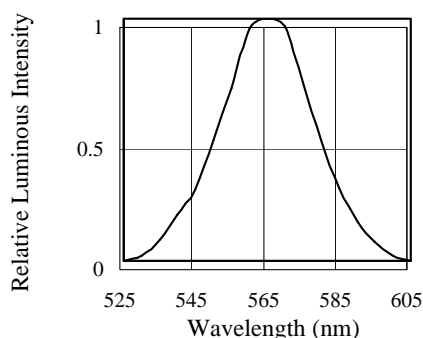

FIG.1 RELATIVE LUMINOUS INTENSITY VS. WAVELENGTH

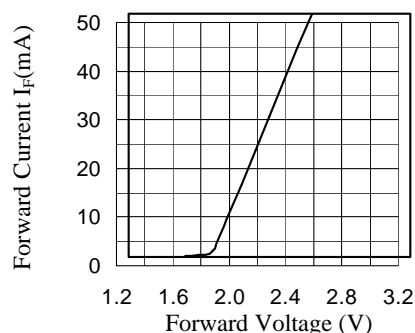

FIG.2 FORWARD CURRENT VS. FORWARD VOLTAGE

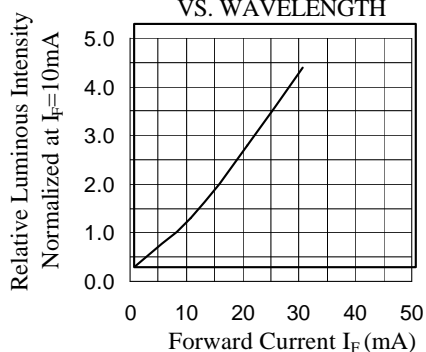

FIG.3 RELATIVE LUMINOUS INTENSITY VS. FORWARD CURRENT

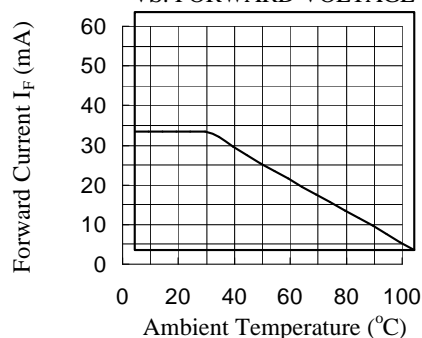

FIG.4 FORWARD CURRENT VS. AMBIENT TEMPERATURE

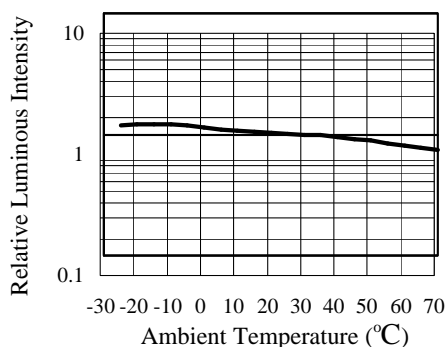

FIG.5 RELATIVE LUMINOUS INTENSITY VS. AMBIENT TEMPERATURE

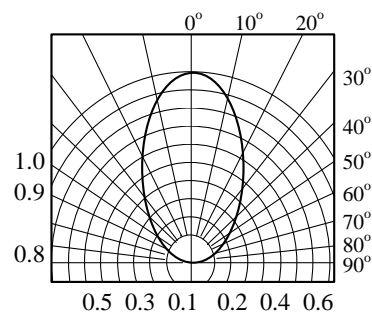

FIG.6 RADIATION DIAGRAM