



FEATURES

- 15 WATTS OUTPUT POWER
- OUTPUT CURRENT UP TO 3A
- STANDARD 2.0 X 1.6 X 0.4 INCH PACKAGE
- HIGH EFFICIENCY UP TO 82%
- 4:1 WIDE INPUT VOLTAGE RANGE
- SIX-SIDED CONTINUOUS SHIELD
- FIXED SWITCHING FREQUENCY
- CE MARK MEETS 2006/95/EC,93/68/EEC AND 2004/108/EC
- UL60950-1, EN60950-1 AND IEC60950-1 LICENSED
- ISO9001 CERTIFIED MANUFACTURING FACILITIES
- COMPLIANT TO RoHS EU DIRECTIVE 2002/95/EC

APPLICATIONS

Wireless Network
Telecom/Datacom
Industry Control System
Measurement Equipment
Semiconductor Equipment

DESCRIPTION

The FDC15 series offer 15 watts of output power from a 2 x 1.6 x 0.4 inch package. The FDC15 series have 4:1 wide input voltage of 9-36 and 18-75VDC. The FDC15 features 1600VDC of isolation, short-circuit and over-voltage protection.

TECHNICAL SPECIFICATION All specifications are typical at nominal input, full load and 25°C otherwise noted

OUTPUT SPECIFICATIONS		
Output power		15 Watts, max.
Voltage accuracy	Full load and nominal Vin	± 1%
Minimum load (Note 6)		See Table
Voltage adjustability		± 10%
Line regulation	LL to HL at Full Load	± 0.2%
Load regulation	Min. load to Full load	Single Dual ± 0.5% ± 1%
Cross regulation (Dual)	Asymmetrical load 25% / 100% FL	± 5%
Ripple and noise	20MHz bandwidth	See table
Temperature coefficient		±0.02% / °C, max.
Transient response recovery time	25% load step change	250µS
Over voltage protection	5V output	6.2VDC
Zener diode clamp	12V output	15VDC
	15V output	18VDC
Over load protection	% of FL at nominal input	150%, max.
Short circuit protection		Hiccup, automatics recovery
GENERAL SPECIFICATIONS		
Efficiency		See table
Isolation voltage		1600VDC, min.
Isolation resistance		10 ⁹ ohms, min.
Isolation capacitance		300pF, max.
Switching frequency		270KHz, typ.
Approvals and standard		IEC60950-1, UL60950-1, EN60950-1
Case material		Nickel-coated copper
Base material		Non-conductive black plastic
Potting material		Epoxy (UL94-V0)
Dimensions		2.00 X 1.60 X 0.40 Inch (50.8 X 40.6 X 10.2 mm)
Weight		48g (1.69oz)
MTBF (Note 1)	BELLCORE TR-NWT-000332 MIL-HDBK-217F	2.041 x 10 ⁶ hrs 9.140 x 10 ⁵ hrs

INPUT SPECIFICATIONS		
Input voltage range	24V nominal input 48V nominal input	9 – 36VDC 18 – 75VDC
Input filter		Pi type
Input surge voltage	24V input 100mS max	50VDC 100VDC
Input reflected ripple current	Nominal Vin and full load	20mA _{p-p}
Start up time	Nominal Vin and constant resistive load	Power up 20mS, typ.
Remote ON/OFF (Note 7)		
(Positive logic)	DC-DC ON DC-DC OFF	Open or 3.5V < Vr < 12V Short or 0V < Vr < 1.2V
Input current of remote control pin	Nominal Vin	-0.5mA~+0.5mA
Remote off state input current	Nominal Vin	20mA
ENVIRONMENTAL SPECIFICATIONS		
Operating ambient temperature		-40°C ~ +85°C (with derating)
Maximum case temperature		100°C
Storage temperature range		-55°C ~ +105°C
Thermal impedance (Note 8)	Nature convection Nature convection with heat-sink	10°C/Watt 8.24°C/Watt
Thermal shock		MIL-STD-810F
Vibration		MIL-STD-810F
Relative humidity		5% to 95% RH
EMC CHARACTERISTICS		
EMI	EN55022	Class A
ESD	EN61000-4-2	Air ± 8KV Contact ± 6KV Perf. Criteria B
Radiated immunity	EN61000-4-3	10 V/m Perf. Criteria A
Fast transient (Note 9)	EN61000-4-4	± 2KV Perf. Criteria B
Surge (Note 9)	EN61000-4-5	± 1KV Perf. Criteria B
Conducted immunity	EN61000-4-6	10 Vr.m.s Perf. Criteria A



Model Number	Input Range	Output Voltage	Output Current		Output (4) Ripple & Noise	Input Current		Eff (4) (%)	Capacitor Load max(5)
			Min. load	Full load		No load (3)	Full load (2)		
FDC15-24S05	9 – 36 VDC	5 VDC	210mA	3000mA	75mVp-p	20mA	822mA	80	6800μF
FDC15-24S12	9 – 36 VDC	12 VDC	100mA	1250mA	75mVp-p	10mA	801mA	82	890μF
FDC15-24S15	9 – 36 VDC	15 VDC	80mA	1000mA	75mVp-p	20mA	801mA	82	570μF
FDC15-24D05	9 – 36 VDC	± 5 VDC	± 105mA	± 1500mA	75mVp-p	20mA	822mA	80	± 1700μF
FDC15-24D12	9 – 36 VDC	± 12 VDC	± 50mA	± 625mA	75mVp-p	20mA	801mA	82	± 300μF
FDC15-24D15	9 – 36 VDC	± 15 VDC	± 40mA	± 500mA	75mVp-p	20mA	801mA	82	± 200μF
FDC15-48S05	18 – 75 VDC	5 VDC	210mA	3000mA	75mVp-p	15mA	411mA	80	6800μF
FDC15-48S12	18 – 75 VDC	12 VDC	100mA	1250mA	75mVp-p	15mA	401mA	82	890μF
FDC15-48S15	18 – 75 VDC	15 VDC	80mA	1000mA	75mVp-p	10mA	401mA	82	570μF
FDC15-48D05	18 – 75 VDC	± 5 VDC	± 105mA	± 1500mA	75mVp-p	10mA	411mA	80	± 1700μF
FDC15-48D12	18 – 75 VDC	± 12 VDC	± 50mA	± 625mA	75mVp-p	20mA	401mA	82	± 300μF
FDC15-48D15	18 – 75 VDC	± 15 VDC	± 40mA	± 500mA	75mVp-p	15mA	401mA	82	± 200μF

Note

- BELLCORE TR-NWT-000332. Case 1: 50% Stress, Temperature at 40°C. MIL-HDBK-217F Notice2 @Ta=25 °C, Full load(Ground, Benign, controlled environment).
- Maximum value at nominal input voltage and full load.
- Typical value at nominal input voltage and no load.
- Typical value at nominal input voltage and full load.
- Test by minimum Vin and constant resistive load.
- The output requires a minimum loading on the output to maintain specified regulation. Operation under no-load condition will not damage these devices, however they may not meet all listed specification.
- The ON/OFF control pin voltage is reference to -Vin.
- Heat-sink is optional and P/N: 7G-0011C-F.
- An external input filter capacitor is required if the module has to meet EN61000-4-4, EN61000-4-5. The filter capacitor Power Mate suggest: Nippon chemi-con KY series, 220μF /100V, ESR 48mΩ.

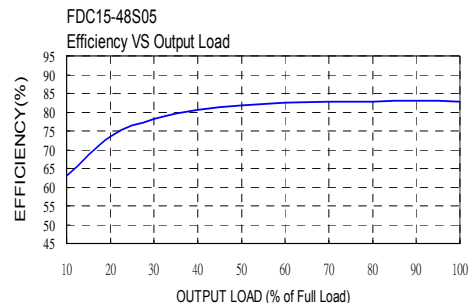
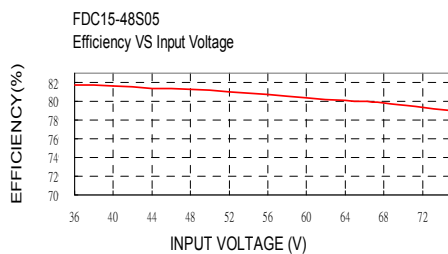
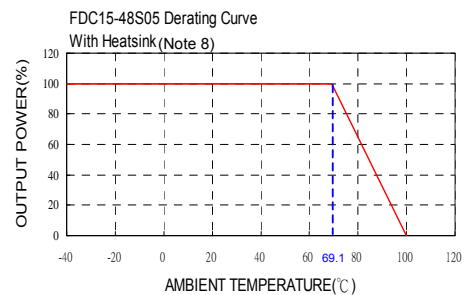
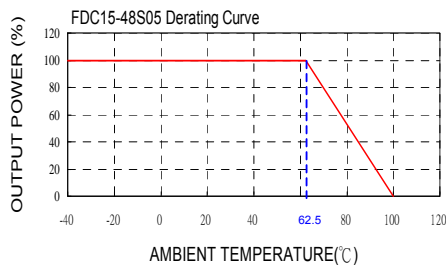



15 WATTS DC-DC CONVERTER

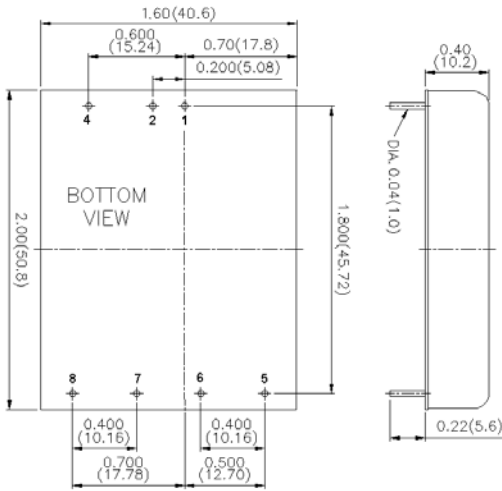

- All dimensions in Inches (mm)
Tolerance: X.XX±0.02 (X.X±0.5)
X.XXX±0.01 (X.XX±0.25)
- Pin pitch tolerance ±0.01(0.25)
- Pin dimension tolerance ±0.004 (0.1)

PIN CONNECTION		
PIN	SINGLE	DUAL
1	+ INPUT	+ INPUT
2	- INPUT	- INPUT
4	CTRL	CTRL
5	NO PIN	+ OUTPUT
6	+ OUTPUT	COMMON
7	- OUTPUT	- OUTPUT
8	TRIM	TRIM

EXTERNAL OUTPUT TRIMMING

Output can be externally trimmed by using the method shown below.
() for dual output trim

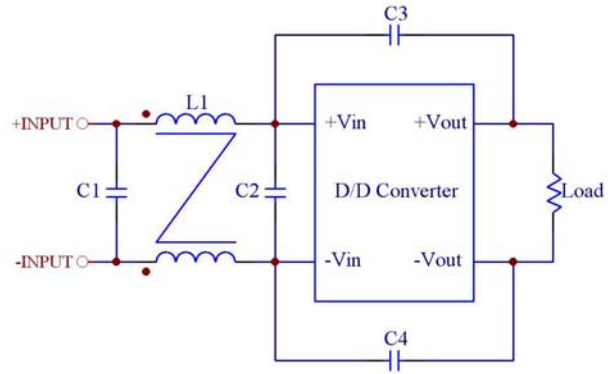
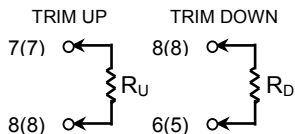

Recommended Filter for EN55022 Class B Compliance

The components used in the above figure, together with the manufacturers' part numbers for these components, are as follows:

	C1	C2	C3	C4	L1
FDC15-24xxx	6.8μF/50V 1812 MLCC	N/A	1000pF/2KV MLCC	1000pF/2KV MLCC	450μH Common Choke PMT-048
FDC15-48xxx	2.2μF/100V 1812 MLCC	2.2μF/100V 1812 MLCC	1000pF/2KV MLCC	1000pF/2KV MLCC	450μH Common Choke PMT-048

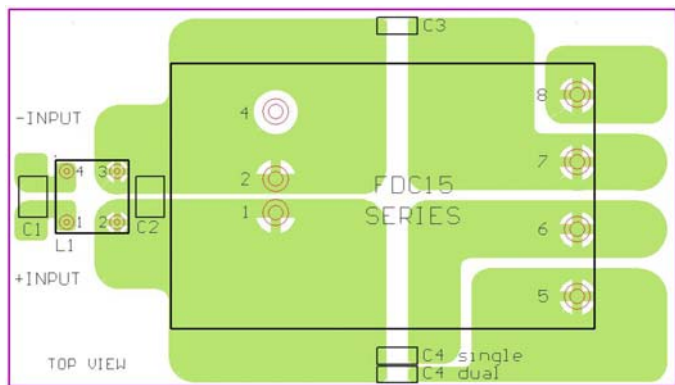

Recommended EN55022 Class B Filter Circuit Layout

