

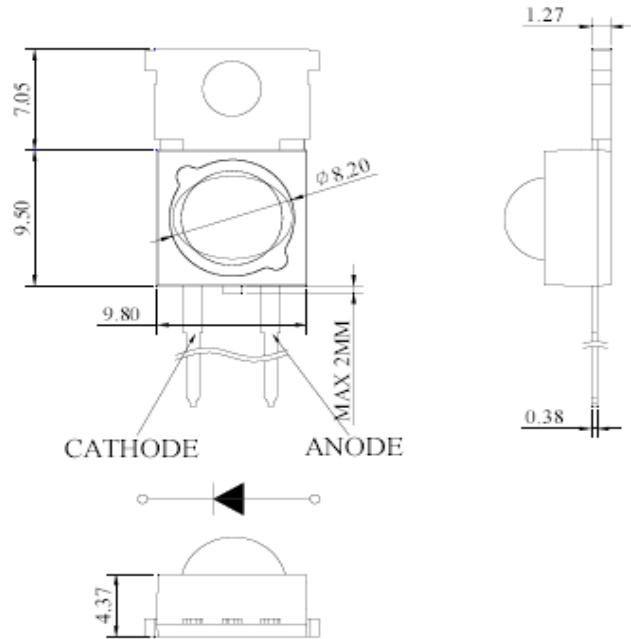

**Ellipse Lens (H60\*V30°)Dip Package Outlines**



**SELECTOR GUIDE**

Part Number	Dice	Lens Color / Type	Pack Size	View Angle 2θ 1/2
MTHF1200-HR	Red	Water Clear	1-Watt	60 ° x 30 °

**ELECTRICAL / OPTICAL CHARACTERISTICS AT T<sub>A</sub>=25°C**

Parameter	Symbol	Device	Min.	Typ.	Max.	Units	Test Conditions
Forward Voltage	V <sub>F</sub>	Red	-	2.2	2.8	V	350mA
Reverse Current	I <sub>R</sub>	Red	-	-	50	µA	5V
Luminous Intensity	I <sub>v</sub>	Red	10.7	20.00	-	lm	350mA
Peak Wavelength	λ <sub>peak</sub>	Red	-	AVL UPON REQUEST	-	nm	350mA
Dominant Wavelength	λ <sub>D</sub>	Red	-	625	-	nm	350mA
Spectral Line Half-Width	Δλ <sub>1/2</sub>	Red	-	NA	-	nm	350mA

**ABSOLUTE MAXIMUM RATINGS AT T<sub>A</sub>=25°C**

Parameter	Rating	Units
Forward Current ( I <sub>F</sub> )	350	mA
Power Dissipation ( P <sub>D</sub> )	-	mW
Reverse Voltage ( V <sub>R</sub> )	5	V
Operating Temperature ( T <sub>OPR</sub> )	-40 ~ +75	°C
Storage Temperature ( T <sub>STG</sub> )	-40 ~ +105	°C
Lead Solder Temperature ( T <sub>SOL</sub> )	260 @ for 10 sec. max	

1. All Dimensions Are In Millimeters (inches).
2. Tolerance Is +0.25(0.01") Unless Otherwise Noted.
3. Specifications Are Subject To Change Without Notice.

**Typical Radiation Pattern for Ellipse Lens(201/2 : Horizontal 60°±10°\*Vertical 30°±10°)**

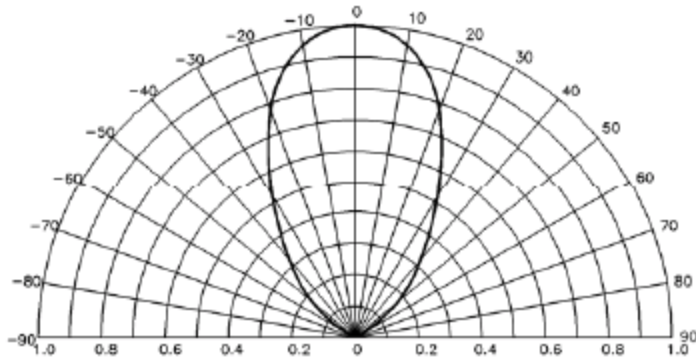

Horizontal 60°

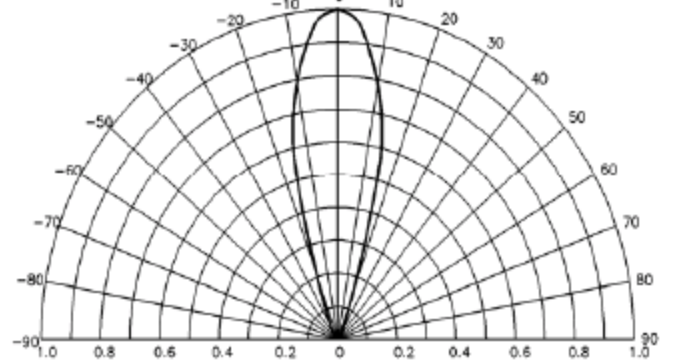

Vertical 30°

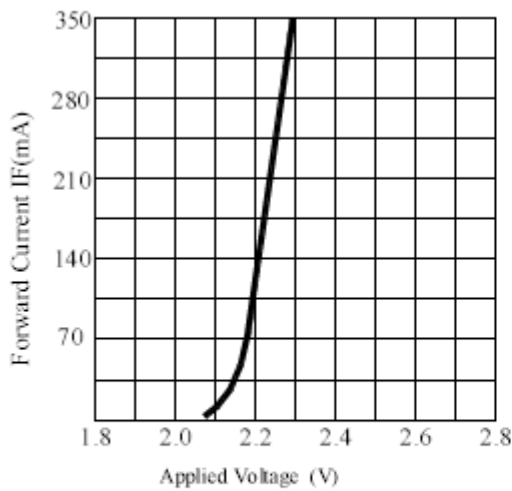

Forward Current VS. Applied Voltage

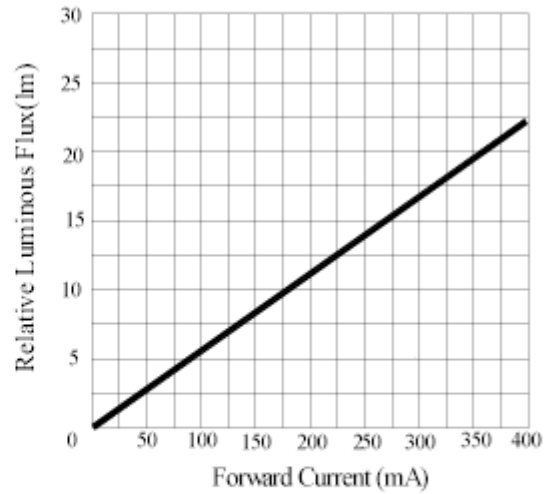

Forward Current VS. Luminous Intensity

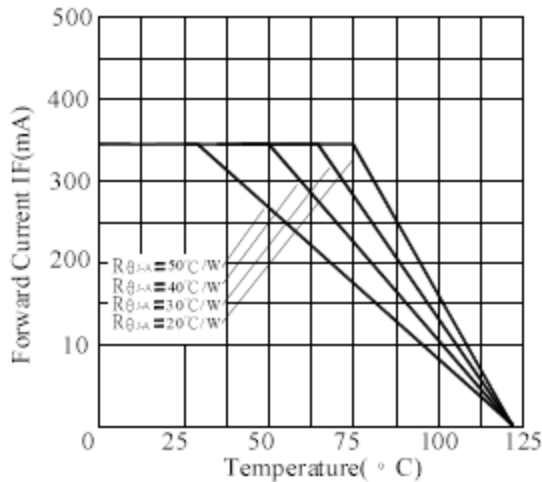

Ambient Temperature VS. Forward Current

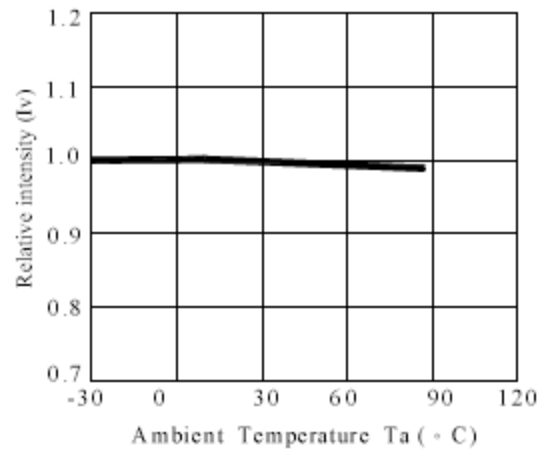

Relative intensity VS. Ambient Temperature

Wavelength Spectrum of Red

