

# Notice for TAIYO YUDEN products

Please read this notice before using the TAIYO YUDEN products.

## REMINDERS

- Product information in this catalog is as of October 2009. All of the contents specified herein are subject to change without notice due to technical improvements, etc. Therefore, please check for the latest information carefully before practical application or usage of the Products.

Please note that Taiyo Yuden Co., Ltd. shall not be responsible for any defects in products or equipment incorporating such products, which are caused under the conditions other than those specified in this catalog or individual specification.

- Please contact Taiyo Yuden Co., Ltd. for further details of product specifications as the individual specification is available.
- Please conduct validation and verification of products in actual condition of mounting and operating environment before commercial shipment of the equipment.
- All electronic components or functional modules listed in this catalog are developed, designed and intended for use in general electronics equipment.(for AV, office automation, household, office supply, information service, telecommunications, (such as mobile phone or PC) etc.). Before incorporating the components or devices into any equipment in the field such as transportation,( automotive control, train control, ship control), transportation signal, disaster prevention, medical, public information network (telephone exchange, base station) etc. which may have direct influence to harm or injure a human body, please contact Taiyo Yuden Co., Ltd. for more detail in advance. Do not incorporate the products into any equipment in fields such as aerospace, aviation, nuclear control, submarine system, military, etc. where higher safety and reliability are especially required.

In addition, even electronic components or functional modules that are used for the general electronic equipment, if the equipment or the electric circuit require high safety or reliability function or performances, a sufficient reliability evaluation check for safety shall be performed before commercial shipment and moreover, due consideration to install a protective circuit is strongly recommended at customer's design stage.

- The contents of this catalog are applicable to the products which are purchased from our sales offices or distributors (so called "TAIYO YUDEN' s official sales channel"). It is only applicable to the products purchased from any of TAIYO YUDEN' s official sales channel.
- Please note that Taiyo Yuden Co., Ltd. shall have no responsibility for any controversies or disputes that may occur in connection with a third party's intellectual property rights and other related rights arising from your usage of products in this catalog. Taiyo Yuden Co., Ltd. grants no license for such rights.

### ■ Caution for export

Certain items in this catalog may require specific procedures for export according to "Foreign Exchange and Foreign Trade Control Law" of Japan, "U.S. Export Administration Regulations", and other applicable regulations. Should you have any question or inquiry on this matter, please contact our sales staff.  
Should you have any question or inquiry on this matter, please contact our sales staff.



**PART NUMBERS**

●NRH 2410 Shielded type

Ordering code	EHS (Environmental Hazardous Substances)	Inductance [ $\mu$ H]	Inductance Tolerance	Self-resonant frequency [MHz] (min.)	DC Resistance [ $\Omega$ ] ( $\pm 20\%$ )	Rated current ※) [mA]		Measuring frequency [kHz]
						Saturation current Idc1	Temperature rise current Idc2	
NRH2410T R68NN 4	RoHS	0.68	$\pm 30\%$	120	0.060	2,200	1,570	100
NRH2410T 1R0NN 4	RoHS	1.0		106	0.070	1,800	1,410	
NRH2410T 1R5MN	RoHS	1.5	$\pm 20\%$	94	0.110	1,550	1,160	
NRH2410T 2R2MN	RoHS	2.2		77	0.150	1,290	970	
NRH2410T 3R3MN	RoHS	3.3		56	0.220	1,000	770	
NRH2410T 4R7MN	RoHS	4.7		50	0.290	880	670	
NRH2410T 6R8MN	RoHS	6.8		43	0.410	750	570	
NRH2410T 100MN	RoHS	10		32	0.690	550	450	
NRH2410T 150MN	RoHS	15		27	1.02	470	370	
NRH2410T 220MN	RoHS	22		22	1.47	390	300	

●NRH 3010 Type

Ordering code	EHS (Environmental Hazardous Substances)	Inductance [ $\mu$ H]	Inductance Tolerance	Self-resonant frequency [MHz] (min.)	DC Resistance [ $\Omega$ ] ( $\pm 20\%$ )	Rated current ※) [mA]		Measuring frequency [kHz]
						Saturation current Idc1	Temperature rise current Idc2	
NRH3010T 1R2N	RoHS	1.2	$\pm 30\%$	120	0.065	1,700	1,480	100
NRH3010T 1R5N	RoHS	1.5		99	0.075	1,440	1,370	
NRH3010T 2R2M	RoHS	2.2	$\pm 20\%$	86	0.083	1,300	1,300	
NRH3010T 3R3M	RoHS	3.3		64	0.130	1,000	1,030	
NRH3010T 4R7M	RoHS	4.7		50	0.170	850	900	
NRH3010T 6R8M	RoHS	6.8		44	0.250	700	745	
NRH3010T 100M	RoHS	10		34	0.350	600	620	
NRH3010T 150M	RoHS	15		25	0.550	450	480	
NRH3010T 220M	RoHS	22		22	0.770	380	410	

●NRH 3012 Type

Ordering code	EHS (Environmental Hazardous Substances)	Inductance [ $\mu$ H]	Inductance Tolerance	Self-resonant frequency [MHz] (min.)	DC Resistance [ $\Omega$ ] ( $\pm 20\%$ )	Rated current ※) [mA]		Measuring frequency [kHz]
						Saturation current Idc1	Temperature rise current Idc2	
NRH3012T 1R0N	RoHS	1.0	$\pm 30\%$	111	0.048	2,200	1,710	100
NRH3012T 1R5N	RoHS	1.5		95	0.055	1,700	1,600	
NRH3012T 2R2M	RoHS	2.2	$\pm 20\%$	78	0.075	1,500	1,370	
NRH3012T 3R3M	RoHS	3.3		61	0.100	1,200	1,210	
NRH3012T 4R7M	RoHS	4.7		50	0.130	1,000	1,060	
NRH3012T 6R8M	RoHS	6.8		43	0.190	850	890	
NRH3012T 100M	RoHS	10		32	0.270	730	720	
NRH3012T 150M	RoHS	15		26	0.450	530	570	
NRH3012T 220M	RoHS	22		22	0.630	500	500	

●NRV 3012 Type

Ordering code	EHS (Environmental Hazardous Substances)	Inductance [ $\mu$ H]	Inductance Tolerance	Self-resonant frequency [MHz] (min.)	DC Resistance [ $\Omega$ ] ( $\pm 20\%$ )	Rated current ※) [mA]		Measuring frequency [kHz]
						Saturation current Idc1	Temperature rise current Idc2	
NRV3012T 2R2M	RoHS	2.2	$\pm 20\%$	70	0.120	1,800	1,100	100

●NRS 5012 Type

Ordering code	EHS (Environmental Hazardous Substances)	Inductance [ $\mu$ H]	Inductance Tolerance	Self-resonant frequency [MHz] (min.)	DC Resistance [ $\Omega$ ] ( $\pm 20\%$ )	Rated current ※) [mA]		Measuring frequency [kHz]
						Saturation current Idc1	Temperature rise current Idc2	
NRS5012T 1R0N	RoHS	1.0	$\pm 30\%$	100	0.053	4,500	2,300	100
NRS5012T 1R5N	RoHS	1.5		86	0.070	3,800	2,200	
NRS5012T 2R2M	RoHS	2.2	$\pm 20\%$	70	0.085	3,100	2,000	
NRS5012T 3R3M	RoHS	3.3		48	0.160	2,400	1,450	
NRS5012T 4R7M	RoHS	4.7		40	0.180	2,200	1,400	
NRS5012T 6R8M	RoHS	6.8		36	0.260	1,700	1,100	
NRS5012T 100M	RoHS	10		26	0.420	1,400	850	

●NRS 5014 Type

Ordering code	EHS (Environmental Hazardous Substances)	Inductance [ $\mu$ H]	Inductance Tolerance	Self-resonant frequency [MHz] (min.)	DC Resistance [ $\Omega$ ] ( $\pm 20\%$ )	Rated current ※) [mA]		Measuring frequency [kHz]
						Saturation current Idc1	Temperature rise current Idc2	
NRS5014T 1R2N	RoHS	1.2	$\pm 30\%$	86	0.045	3,800	2,800	100
NRS5014T 2R2N	RoHS	2.2		56	0.065	2,800	2,300	
NRS5014T 3R3N	RoHS	3.3		48	0.080	2,350	2,100	
NRS5014T 4R7N	RoHS	4.7		41	0.100	2,050	1,800	

\* This catalog contains the typical specification only due to the limitation of space. When you consider purchase of our products, please check our specification. For details of each product (characteristics graph, reliability information, precautions for use, and so on), see our Web site (<http://www.ty-top.com/>) or CD catalogs.

■ PART NUMBERS

● NRS 5020 Type

Ordering code		EHS (Environmental Hazardous Substances)	Inductance [ $\mu$ H]	Inductance Tolerance	Self-resonant frequency [MHz] (min.)	DC Resistance [ $\Omega$ ] ( $\pm 20\%$ )	Rated current ※) [mA]		Measuring frequency [kHz]
							Saturation current Idc1	Temperature rise current Idc2	
NRS5020T 1R0N		RoHS	1.0	$\pm 30\%$	81	0.021	4,000	3,600	100
NRS5020T 1R5N		RoHS	1.5		68	0.026	3,350	3,200	
NRS5020T 2R2N		RoHS	2.2		57	0.035	2,900	2,900	
NRS5020T 3R3N		RoHS	3.3	46	0.048	2,400	2,400		
NRS5020T 4R7M		RoHS	4.7	$\pm 20\%$	37	0.060	2,000	2,000	
NRS5020T 6R8M		RoHS	6.8		30	0.090	1,600	1,650	
NRS5020T 100M		RoHS	10		24	0.120	1,300	1,450	
NRS5020T 150M		RoHS	15		20	0.165	1,100	1,200	
NRS5020T 220M		RoHS	22		17	0.260	900	1,000	

● NRS 6010 Type

Ordering code		EHS (Environmental Hazardous Substances)	Inductance [ $\mu$ H]	Inductance Tolerance	Self-resonant frequency [MHz] (min.)	DC Resistance [ $\Omega$ ] ( $\pm 20\%$ )	Rated current ※) [mA]		Measuring frequency [kHz]
							Saturation current Idc1	Temperature rise current Idc2	
NRS6010T 1R5N		RoHS	1.5	$\pm 30\%$	90	0.090	2,400	1,900	100
NRS6010T 2R2N		RoHS	2.2		65	0.110	1,900	1,700	
NRS6010T 3R3N		RoHS	3.3		50	0.135	1,600	1,500	
NRS6010T 4R7N		RoHS	4.7		38	0.165	1,300	1,400	
NRS6010T 6R8N		RoHS	6.8		30	0.220	1,200	1,200	
NRS6010T 100M		RoHS	10	$\pm 20\%$	25	0.270	1,000	1,100	

※) The saturation current value (Idc1) is the DC current value having inductance decrease down to 30%. (at 20°C)

※) The temperature rise current value (Idc2) is the DC current value having temperature increase up to 40°C. (at 20°C)

※) The rated current is the DC current value that satisfies both of current value saturation current value and temperature rise current value.

DC Bias characteristics

(Measured by HP4285A)

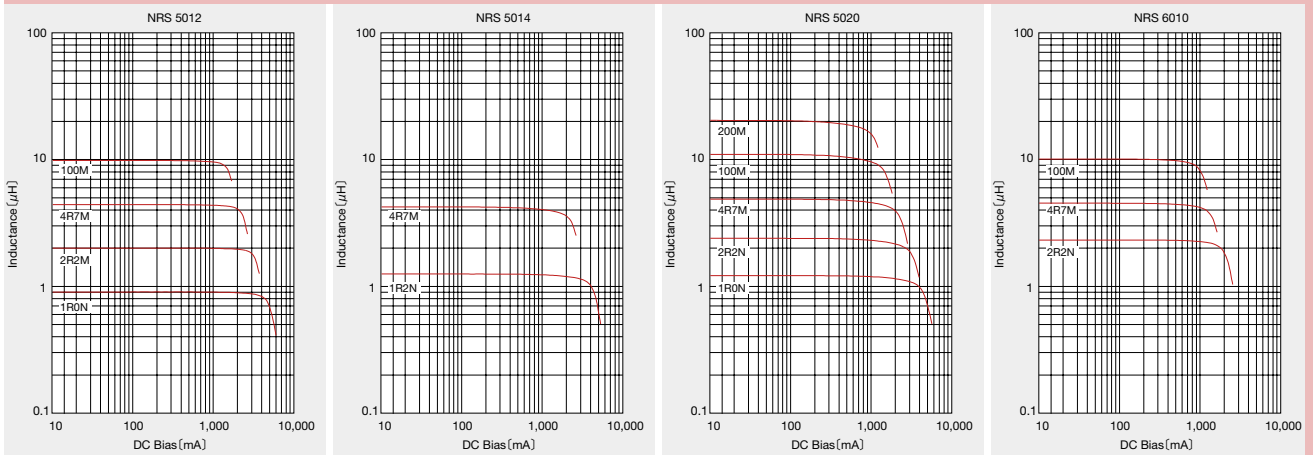
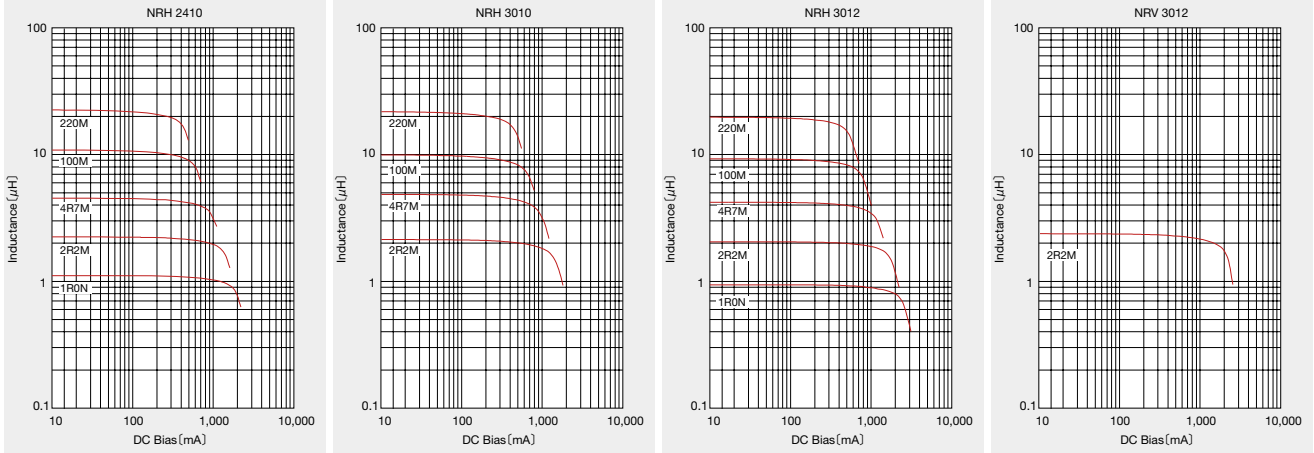

\* This catalog contains the typical specification only due to the limitation of space. When you consider purchase of our products, please check our specification. For details of each product (characteristics graph, reliability information, precautions for use, and so on), see our Web site (<http://www.ty-top.com/>) or CD catalogs.

**PACKAGING**

① Minimum Quantity

Type	Standard Quantity [pcs]	
	Tape & Reel	
NRH 2410	2500	
NR 3010/NRH 3010	2000	
NR 3012/NRH3012/NRV3012	2000	
NR 3015	2000	
NR 4010	5000	
NR 4012	4500	
NR 4018	3500	
NRG4026	2000	
NRS5012	1000	
NRS5014	1000	
NRS5020	800	
NR 5040	1500	
NRS6010	1000	
NR 6012	1000	
NR 6020	2500	
NR 6028	2000	
NR 6045	1500	
NR 8040	1000	

② Tape Material

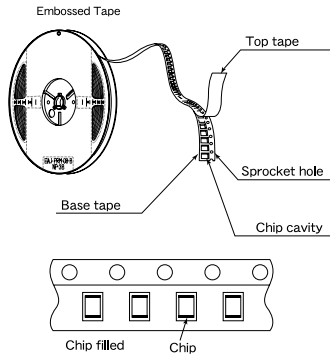

③ Taping dimensions

- Embossed tape 8mm wide (0.315 inches wide)

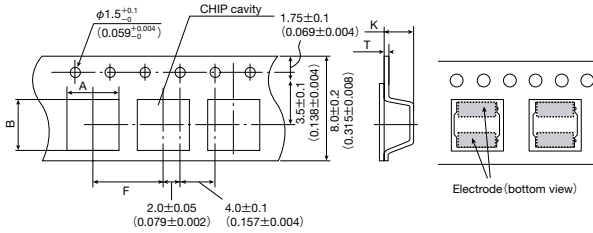

Type	Chip cavity		Insertion pitch F	Tape thickness	
	A	B		T	K
NRH 2410	2.6±0.1 (0.102±0.004)	2.6±0.1 (0.102±0.004)	4.0±0.1 (0.157±0.004)	0.25±0.05 (0.009±0.002)	1.3±0.1 (0.051±0.004)
NR 3010 NRH 3010	3.2±0.1 (0.126±0.004)	3.2±0.1 (0.126±0.004)		0.3±0.05 (0.012±0.002)	1.4±0.1 (0.055±0.004)
NR 3012 NRH 3012 NRV3012			1.6±0.1 (0.063±0.004)		
NR 3015			1.9±0.1 (0.075±0.004)		

Unit : mm (inch)

- Embossed tape 12mm wide (0.47 inches wide)

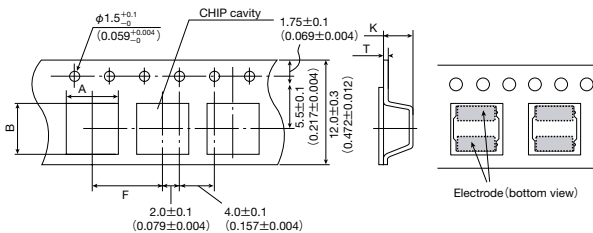

Type	Chip cavity		Insertion pitch F	Tape thickness	
	A	B		T	K
NR 4010	4.3±0.1 (0.169±0.004)	4.3±0.1 (0.169±0.004)	8.0±0.1 (0.315±0.004)	0.3±0.05 (0.012±0.002)	1.4±0.1 (0.055±0.004)
NR 4012				1.6±0.1 (0.063±0.004)	
NR 4018				2.1±0.1 (0.083±0.004)	
NRG 4026				3.1±0.1 (0.122±0.004)	
NRS 5012	5.25±0.1 (0.207±0.004)	5.25±0.1 (0.207±0.004)	8.0±0.1 (0.315±0.004)	0.3±0.05 (0.012±0.002)	1.4±0.1 (0.055±0.004)
NRS 5014					1.6±0.1 (0.063±0.004)
NRS 5020	5.15±0.1 (0.203±0.004)	5.15±0.1 (0.203±0.004)	8.0±0.1 (0.315±0.004)	0.3±0.05 (0.012±0.002)	2.3±0.1 (0.091±0.004)
NR 5040					4.2±0.1 (0.165±0.004)
NRS 6010	6.3±0.1 (0.248±0.004)	6.3±0.1 (0.248±0.004)	8.0±0.1 (0.315±0.004)	0.4±0.1 (0.016±0.004)	1.4±0.1 (0.055±0.004)
NR 6012					1.6±0.1 (0.063±0.004)
NR 6020					2.3±0.1 (0.090±0.004)
NR 6028					3.1±0.1 (0.122±0.004)
NR 6045	6.3±0.1 (0.248±0.004)	6.3±0.1 (0.248±0.004)	8.0±0.1 (0.315±0.004)	0.4±0.1 (0.016±0.004)	4.7±0.1 (0.185±0.004)
NR 8040					4.5±0.1 (0.177±0.004)

Unit : mm (inch)

- Embossed tape 16mm wide (0.63 inches wide)

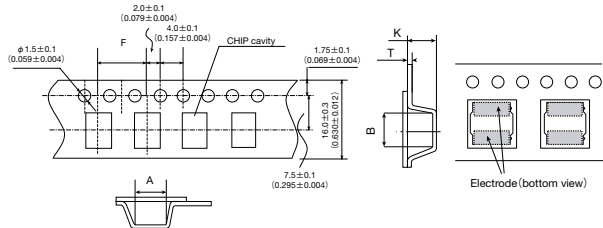

Type	Chip cavity		Insertion pitch F	Tape thickness	
	A	B		T	K
NR 8040	8.3±0.1 (0.327±0.004)	8.3±0.1 (0.327±0.004)	12.0±0.1 (0.472±0.004)	0.5±0.1 (0.020±0.004)	4.5±0.1 (0.177±0.004)

Unit : mm (inch)

④ Leader and Blank portion

- NR, NRH, NRS, NRG, NRV

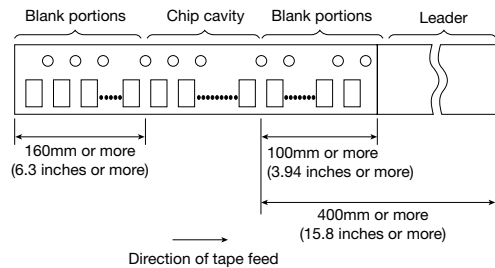

\* This catalog contains the typical specification only due to the limitation of space. When you consider purchase of our products, please check our specification. For details of each product (characteristics graph, reliability information, precautions for use, and so on), see our Web site (<http://www.ty-top.com/>) or CD catalogs.

⑤ Reel size

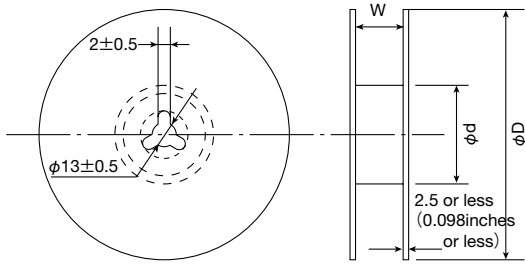

Type	Reel size (Reference values)		
	φD	φd	W
NRH2410	180±0.5 (7.087±0.019)	60±1.0 (2.36±0.04)	10.0±1.5 (0.394±0.059)
NR 3010			
NRH 3010			
NR 3012			
NRV 3012			
NR 3015	180±3.0 (7.087±0.118)	60±2.0 (2.36±0.08)	14.0±1.5 (0.551±0.059)
NRS 5012			
NRS 5014			
NRS 5020			
NRS 6010			
NR 6012			

Unit : mm (inch)

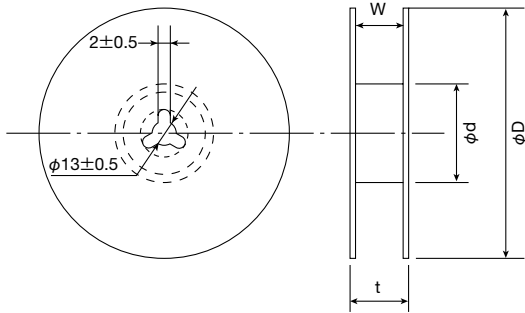

Type	Reel size (Reference values)			
	φD	φd	t (max.)	W
NR 4010	330±3.0 (12.99±0.118)	80±2.0 (3.15±0.078)	18.5 (0.72)	13.5±1.0 (0.531±0.04)
NR 4012				
NR 4018				
NRG 4026				
NR 5040				
NR 6020				
NR 6028				
NR 6045				
NR 8040			22.5 (0.89)	17.5±1.0 (0.689±0.04)

Unit : mm (inch)

⑥ Top Tape Strength

The top tape requires a peel-off force of 0.1 to 1.3N in the direction of the arrow as illustrated below.

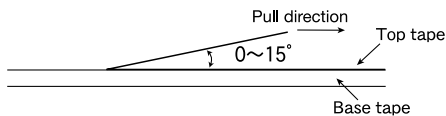

\* This catalog contains the typical specification only due to the limitation of space. When you consider purchase of our products, please check our specification. For details of each product (characteristics graph, reliability information, precautions for use, and so on), see our Web site (<http://www.ty-top.com/>) or CD catalogs.

## RELIABILITY DATA

1. Operating Temperature Range	
BRC1608, BRL2012, BRC2016, BRC2518, BRFL2518, BRL2518, BRL3225 Type	-25~+105°C
NR30/40/50/60/80, NRV30, NRG40, NRH24/30, NRS50/60 Type	-25~+120°C
NR10050 Type	-25~+105°C
【Test Method and Remarks】 Including self-generated heat	
2. Storage Temperature Range	
BRC1608, BRL2012, BRC2016, BRC2518, BRFL2518, BRL2518, BRL3225 Type	-40~+85°C
NR30/40/50/60/80, NRV30, NRG40, NRH24/30, NRS50/60 Type	
NR10050 Type	
【Test Method and Remarks】 BRC1608, BRL2012, BRC2016, BRC2518, BRFL2518, BRL2518, BRL3225 Type, NR30/40/50/60/80, NRV30, NRG40, NRH24/30, NRS50/60 Type : 0 to 40°C for the product with taping. NR10050 Type : 0~40°C for the product with taping.	
3. Rated current	
BRC1608, BRL2012, BRC2016, BRC2518, BRFL2518, BRL2518, BRL3225 Type	Within the specified tolerance
NR30/40/50/60/80, NRV30, NRG40, NRH24/30, NRS50/60 Type	
NR10050 Type	
4. Inductance	
BRC1608, BRL2012, BRC2016, BRC2518, BRFL2518, BRL2518, BRL3225 Type	Within the specified tolerance
NR30/40/50/60/80, NRV30, NRG40, NRH24/30, NRS50/60 Type	
NR10050 Type	
【Test Method and Remarks】 BRC1608, BRL2012, BRC2016, BRC2518, BRFL2518, BRL2518, BRL3225 Type : LCR Meter : HP 4285A or equivalent, Measuring frequency : Specified frequency NR30/40/50/60/80, NRV30, NRG40, NRH24/30, NRS50/60 Type : LCR Meter : HP 4285A or equivalent, 100KHz, 1V NR10050 Type : LCR Meter : HP 4263A or equivalent, 100KHz, 1V	
5. DC Resistance	
BRC1608, BRL2012, BRC2016, BRC2518, BRFL2518, BRL2518, BRL3225 Type	Within the specified tolerance
NR30/40/50/60/80, NRV30, NRG40, NRH24/30, NRS50/60 Type	
NR10050 Type	
【Test Method and Remarks】 DC ohmmeter : HIOKI 3227 or equivalent	
6. Self resonance frequency	
BRC1608, BRL2012, BRC2016, BRC2518, BRFL2518, BRL2518, BRL3225 Type	Within the specification
NR30/40/50/60/80, NRV30, NRG40, NRH24/30, NRS50/60 Type	
NR10050 Type	
【Test Method and Remarks】 BRC1608, BRL2012, BRC2016, BRC2518, BRFL2518, BRL2518, BRL3225 Type, NR30/40/50/60/80, NRV30, NRG40, NRH24/30, NRS50/60 Type, NR10050 Type : Impedance analyzer/material analyzer : HP4291A or equivalent HP4191A, 4192A or equivalent	
7. Temperature characteristic	
BRC1608, BRL2012, BRC2016, BRC2518, BRFL2518, BRL2518, BRL3225 Type	BRL2012, BRC2016, BRL2518, BRL3225, BRC2518, BRFL2518 Inductance change : Within ±15%
NR30/40/50/60/80, NRV30, NRG40, NRH24/30, NRS50/60 Type	BRC1608 Inductance change : Within ±20%
NR10050 Type	Inductance change : Within ±20%
【Test Method and Remarks】 BRC1608, BRL2012, BRC2016, BRC2518, BRFL2518, BRL2518, BRL3225 Type, NR30/40/50/60/80, NRV30, NRG40, NRH24/30, NRS50/60 Type, NR10050 Type : Measurement of inductance shall be taken at temperature range within -25°C~+85°C. With reference to inductance value at +20°C., change rate shall be calculated.	
Change of maximum inductance deviation in step 1 to 5	
Temperature at step 1	20°C
Temperature at step 2	Minimum operating temperature
Temperature at step 3	20°C (Standard temperature)
Temperature at step 4	Maximum operating temperature
Temperature at step 5	20°C

\* This catalog contains the typical specification only due to the limitation of space. When you consider purchase of our products, please check our specification.  
For details of each product (characteristics graph, reliability information, precautions for use, and so on), see our Web site (<http://www.ty-top.com/>) or CD catalogs.



## RELIABILITY DATA

### 8. Resistance to flexure of substrate

BRC1608, BRL2012, BRC2016, BRC2518, BRFL2518, BRL2518, BRL3225 Type	No damage.
NR30/40/50/60/80, NRV30, NRG40, NRH24/30, NRS50/60 Type	
NR10050 Type	

#### [Test Method and Remarks]

BRC1608, BRL2012, BRC2016, BRC2518, BRFL2518, BRL2518, BRL3225 Type, NR30/40/50/60/80, NRV30, NRG40, NRH24/30, NRS50/60 Type :

The test samples shall be soldered to the test board by the reflow. As illustrated below, apply force in the direction of the arrow indicating until deflection of the test board reaches to 2 mm.

Test board size : 100×40×1.0  
 Test board material : glass epoxy-resin  
 Solder cream thickness : 0.12 (BR Series)  
 0.10 (NR30/40, NRV30, NRH24/30, NRG40)  
 0.15 (NR50/60/80, NRS50/60)

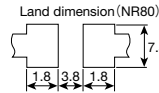
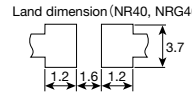
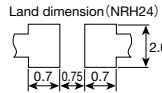
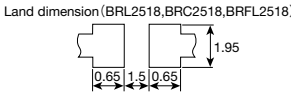
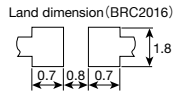
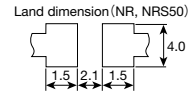
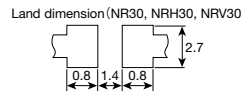
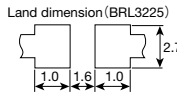
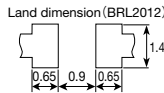
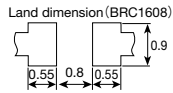
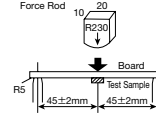

Printed board thickness : 1.0mm  
 Unit : mm

### 9. Insulation resistance : between wires

BRC1608, BRL2012, BRC2016, BRC2518, BRFL2518, BRL2518, BRL3225 Type	
NR30/40/50/60/80, NRV30, NRG40, NRH24/30, NRS50/60 Type	
NR10050 Type	

### 10. Insulation resistance : between wire and core

BRC1608, BRL2012, BRC2016, BRC2518, BRFL2518, BRL2518, BRL3225 Type	
NR30/40/50/60/80, NRV30, NRG40, NRH24/30, NRS50/60 Type	
NR10050 Type	

### 11. Withstanding voltage : between wires and core

BRC1608, BRL2012, BRC2016, BRC2518, BRFL2518, BRL2518, BRL3225 Type	
NR30/40/50/60/80, NRV30, NRG40, NRH24/30, NRS50/60 Type	
NR10050 Type	

### 12. Adhesion of terminal electrode

BRC1608, BRL2012, BRC2016, BRC2518, BRFL2518, BRL2518, BRL3225 Type	Shall not come off PC board.
NR30/40/50/60/80, NRV30, NRG40, NRH24/30, NRS50/60 Type	
NR10050 Type	

#### [Test Method and Remarks]

BRC2012, BRC2016, BRC2518, BRFL2518, BRL2518, BRL3225 Type, NR30/40/50/60/80, NRV30, NRG40, NRH24/30, NRS50/60 Type :

The test samples shall be soldered to the test board by the reflow.

- Applied force : 10N to X and Y directions.
- Duration : 5s.
- Solder cream thickness : 0.15mm.

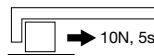

BRC1608, NR10050 Type :

- Applied force : 5N to X and Y directions.
- Duration : 5s.

### 13. Resistance to vibration

BRC1608, BRL2012, BRC2016, BRC2518, BRFL2518, BRL2518, BRL3225 Type	Inductance change : Within ±10% No significant abnormality in appearance.
NR30/40/50/60/80, NRV30, NRG40, NRH24/30, NRS50/60 Type	
NR10050 Type	

#### [Test Method and Remarks]

BRC1608, BRL2012, BRC2016, BRC2518, BRFL2518, BRL2518, BRL3225 Type, NR30/40/50/60/80, NRV30, NRG40, NRH24/30, NRS50/60 Type, NR10050 Type :

The test samples shall be soldered to the test board by the reflow.

Then it shall be submitted to below test conditions.

Frequency Range	10~55Hz	
Total Amplitude	1.5mm (May not exceed acceleration 196m/s <sup>2</sup> )	
Sweeping Method	10Hz to 55Hz to 10Hz for 1min.	
Time	X	For 2 hours on each X, Y, and Z axis.
	Y	
	Z	

Recovery : At least 2hrs of recovery under the standard condition after the test, followed by the measurement within 48hrs.

\* This catalog contains the typical specification only due to the limitation of space. When you consider purchase of our products, please check our specification. For details of each product (characteristics graph, reliability information, precautions for use, and so on), see our Web site (<http://www.ty-top.com/>) or CD catalogs.

## RELIABILITY DATA

### 14. Solderability

BRC1608, BRL2012, BRC2016, BRC2518, BRFL2518, BRL2518, BRL3225 Type	At least 90% of surface of terminal electrode is covered by new solder.
NR30/40/50/60/80, NRV30, NRG40, NRH24/30, NRS50/60 Type	
NR10050 Type	

#### [Test Method and Remarks]

BRC1608, BRL2012, BRC2016, BRC2518, BRFL2518, BRL2518, BRL3225 Type, NR30/40/50/60/80, NRV30, NRG40, NRH24/30, NRS50/60 Type, NR10050 Type :  
The test samples shall be dipped in flux, and then immersed in molten solder as shown in below table.  
Flux : Methanol solution containing rosin 25%.

NR30/40/50/60/80, NRV30, NRG40, NRH24/30, NRS50/60 Type :

Solder Temperature	245±5°C
Time	5±1.0 sec.

BRC1608, BRL2012, BRC2016, BRC2518, BRFL2518, BRL2518, BRL3225 Type :

Solder Temperature	245±5°C
Time	5±0.5 sec.

※Immersion depth : All sides of mounting terminal shall be immersed.

### 15. Resistance to soldering heat

BRC1608, BRL2012, BRC2016, BRC2518, BRFL2518, BRL2518, BRL3225 Type	Inductance change : Within ±10% No significant abnormality in appearance.
NR30/40/50/60/80, NRV30, NRG40, NRH24/30, NRS50/60 Type	
NR10050 Type	

#### [Test Method and Remarks]

BRC1608, BRL2012, BRC2016, BRC2518, BRFL2518, BRL2518, BRL3225 Type :  
3 times of reflow oven at 230°C MIN. for 40sec. with peak temperature at 260<sup>+0</sup><sub>-5</sub>°C for 5sec.

NR30/40/50/60/80, NRV30, NRG40, NRH24/30, NRS50/60 Type, NR10050 Type :  
The test sample shall be exposed to reflow oven at 230±5°C for 40 seconds, with peak temperature at 260±5°C for 5 seconds, 2 times.

NR6020 Type :

The test sample shall be exposed to reflow oven at 230±5°C for 40 seconds, with peak temperature at 250<sup>+0</sup><sub>-5</sub>°C for 5 seconds, 2 times.

Test board thickness : 1.0mm

Test board material : glass epoxy-resin

### 16. Thermal shock

BRC1608, BRL2012, BRC2016, BRC2518, BRFL2518, BRL2518, BRL3225 Type	Inductance change : Within ±10% No significant abnormality in appearance.
NR30/40/50/60/80, NRV30, NRG40, NRH24/30, NRS50/60 Type	
NR10050 Type	

#### [Test Method and Remarks]

BRC1608, BRL2012, BRC2016, BRC2518, BRFL2518, BRL2518, BRL3225 Type, NR30/40/50/60/80, NRV30, NRG40, NRH24/30, NRS50/60 Type, NR10050 Type :  
The test samples shall be soldered to the test board by the reflow. The test samples shall be placed at specified temperature for specified time by step 1 to step 4 as shown in below table in sequence. The temperature cycle shall be repeated 100 cycles.

Conditions of 1 cycle		
Step	Temperature (°C)	Duration (min)
1	-40±3	30±3
2	Room temperature	Within 3
3	+85±2	30±3
4	Room temperature	Within 3

### 17. Damp heat

BRC1608, BRL2012, BRC2016, BRC2518, BRFL2518, BRL2518, BRL3225 Type	Inductance change : Within ±10% No significant abnormality in appearance.
NR30/40/50/60/80, NRV30, NRG40, NRH24/30, NRS50/60 Type	
NR10050 Type	

#### [Test Method and Remarks]

BRC1608, BRL2012, BRC2016, BRC2518, BRFL2518, BRL2518, BRL3225 Type :

Temperature	60±2°C
Humidity	90~95%RH
Time	1000 hours.

Recovery : At least 2hrs of recovery under the standard condition after the test, followed by the measurement within 48 hrs.

NR30/40/50/60/80, NRV30, NRG40, NRH24/30, NRS50/60 Type :

The test samples shall be soldered to the test board by the reflow.

The test samples shall be placed in thermostatic oven set at specified temperature and humidity as shown in below table.

Temperature	60±2°C
Humidity	90~95%RH
Time	500±24hour

\* This catalog contains the typical specification only due to the limitation of space. When you consider purchase of our products, please check our specification.  
For details of each product (characteristics graph, reliability information, precautions for use, and so on), see our Web site (<http://www.ty-top.com/>) or CD catalogs.

## RELIABILITY DATA

### 18. Loading under damp heat

BRC1608, BRL2012, BRC2016, BRC2518, BRFL2518, BRL2518, BRL3225 Type	Inductance change : Within $\pm 10\%$ No significant abnormality in appearance.
NR30/40/50/60/80, NRV30, NRG40, NRH24/30, NRS50/60 Type	
NR10050 Type	

**[Test Method and Remarks]**

BRC1608, BRL2012, BRC2016, BRC2518, BRFL2518, BRL2518, BRL3225 Type :

Temperature	60 $\pm$ 2 $^{\circ}$ C
Humidity	90~95%RH
Applied current	Rated current
Time	1000hours.

Recovery : At least 2hrs of recovery under the standard condition after the test, followed by the measurement within 48 hrs.

NR30/40/50/60/80, NRV30, NRG40, NRH24/30, NRS50/60 Type, NR10050 Type :

The test samples shall be soldered to the test board by the reflow.

The test samples shall be placed in thermostatic oven set at specified temperature and humidity and applied the rated current continuously as shown in below table.

Temperature	60 $\pm$ 2 $^{\circ}$ C
Humidity	90~95%RH
Applied current	Rated current
Time	500 $\pm$ 2hour

### 19. Low temperature life test

BRC1608, BRL2012, BRC2016, BRC2518, BRFL2518, BRL2518, BRL3225 Type	Inductance change : Within $\pm 10\%$ No significant abnormality in appearance.
NR30/40/50/60/80, NRV30, NRG40, NRH24/30, NRS50/60 Type	
NR10050 Type	

**[Test Method and Remarks]**

BRC1608, BRL2012, BRC2016, BRC2518, BRFL2518, BRL2518, BRL3225 Type :

Temperature	-40 $\pm$ 2 $^{\circ}$ C
Duration	1000hours

Recovery : At least 2hrs of recovery under the standard condition after the test, followed by the measurement within 48 hrs.

NR30/40/50/60/80, NRV30, NRG40, NRH24/30, NRS50/60 Type, NR10050 Type :

The test samples shall be soldered to the test board by the reflow.

After that, the test samples shall be placed at test conditions as shown in below table.

Temperature	-40 $\pm$ 3 $^{\circ}$ C
Time	500 $\pm$ 24hour

### 20. High temperature life test

BRC1608, BRL2012, BRC2016, BRC2518, BRFL2518, BRL2518, BRL3225 Type	Inductance change : Within $\pm 10\%$ No significant abnormality in appearance.
NR30/40/50/60/80, NRV30, NRG40, NRH24/30, NRS50/60 Type	
NR10050 Type	Inductance change : Within $\pm 10\%$ No significant abnormality in appearance.

**[Test Method and Remarks]**

BRC1608, BRL2012, BRC2016, BRC2518, BRFL2518, BRL2518, BRL3225 Type :

Temperature	85 $\pm$ 2 $^{\circ}$ C
Duration	1000hours

Recovery : At least 2hrs of recovery under the standard condition after the test, followed by the measurement within 48 hrs.

NR10050 Type :

Temperature	105 $\pm$ 3 $^{\circ}$ C
Time	500 $\pm$ 24hour

Recovery : At least 2hrs of recovery under the standard condition after the test, followed by the measurement within 48 hrs.

### 21. Loading at high temperature life test

BRC1608, BRL2012, BRC2016, BRC2518, BRFL2518, BRL2518, BRL3225 Type	Inductance change : Within $\pm 10\%$ No significant abnormality in appearance.
NR30/40/50/60/80, NRV30, NRG40, NRH24/30, NRS50/60 Type	
NR10050 Type	

**[Test Method and Remarks]**

NR30/40/50/60/80, NRV30, NRG40, NRH24/30, NRS50/60 Type :

The test samples shall be soldered to the test board by the reflow soldering.

Temperature	85 $\pm$ 2 $^{\circ}$ C
Applied current	Rated current
Time	500 $\pm$ 24hour

### 22. Standard condition

BRC1608, BRL2012, BRC2016, BRC2518, BRFL2518, BRL2518, BRL3225 Type	Standard test condition : Unless otherwise specified, temperature is 20 $\pm$ 15% and 65 $\pm$ 20% of relative humidity. When there are question concerning measurement result : In order to provide correlation date, the test shall be condition of 20 $\pm$ 2 $^{\circ}$ C of temperature, 65 $\pm$ 5% relative humidity. Inductance is in accordance with our measured value.
NR30/40/50/60/80, NRV30, NRG40, NRH24/30, NRS50/60 Type	
NR10050 Type	

\* This catalog contains the typical specification only due to the limitation of space. When you consider purchase of our products, please check our specification.  
For details of each product (characteristics graph, reliability information, precautions for use, and so on), see our Web site (<http://www.ty-top.com/>) or CD catalogs.

## PRECAUTIONS

### SMD Inductors

1. Circuit Design	
Precautions	<ul style="list-style-type: none"> <li>◆ Operating environment               <ol style="list-style-type: none"> <li>1. The products described in this specification are intended for use in general electronic equipment, (office supply equipment, telecommunications systems, measuring equipment, and household equipment). They are not intended for use in mission-critical equipment or systems requiring special quality and high reliability (traffic systems, safety equipment, aerospace systems, nuclear control systems and medical equipment including life-support systems,) where product failure might result in loss of life, injury or damage. For such uses, contact TAIYO YUDEN Sales Department in advance.</li> </ol> </li> </ul>
2. PCB Design	
Precautions	<ul style="list-style-type: none"> <li>◆ Land pattern design               <ol style="list-style-type: none"> <li>1. Please refer to a recommended land pattern.</li> </ol> </li> </ul>
Technical considerations	<ul style="list-style-type: none"> <li>◆ Land pattern design               <ul style="list-style-type: none"> <li>Surface Mounting</li> <li>• Mounting and soldering conditions should be checked beforehand.</li> <li>• Applicable soldering process to this products is reflow soldering only.</li> </ul> </li> </ul>
3. Considerations for automatic placement	
Precautions	<ul style="list-style-type: none"> <li>◆ Adjustment of mounting machine               <ol style="list-style-type: none"> <li>1. Excessive impact load should not be imposed on the products when mounting onto the PC boards.</li> <li>2. Mounting and soldering conditions should be checked beforehand.</li> </ol> </li> </ul>
Technical considerations	<ul style="list-style-type: none"> <li>◆ Adjustment of mounting machine               <ol style="list-style-type: none"> <li>1. When installing products, care should be taken not to apply distortion stress as it may deform the products.</li> </ol> </li> </ul>
4. Soldering	
Precautions	<ul style="list-style-type: none"> <li>◆ Reflow soldering               <ol style="list-style-type: none"> <li>1. Please contact any of our offices for a reflow soldering, and refer to the recommended condition specified.</li> <li>2. This products is reflow soldering only.</li> <li>3. Please do not add any stress to a product until it returns in normal temperature after reflow soldering.</li> </ol> </li> <li>◆ Lead free soldering               <ol style="list-style-type: none"> <li>1. When using products with lead free soldering, we request to use them after confirming of adhesion, temperature of resistance to soldering heat, soldering etc sufficiently.</li> </ol> </li> <li>◆ Recommended conditions for using a soldering iron (NR10050 Type)               <ul style="list-style-type: none"> <li>• Put the soldering iron on the land-pattern.</li> <li>• Soldering iron's temperature - Below 350°C</li> <li>• Duration - 3 seconds or less</li> <li>• The soldering iron should not directly touch the inductor.</li> </ul> </li> </ul>
Technical considerations	<ul style="list-style-type: none"> <li>◆ Reflow soldering               <ol style="list-style-type: none"> <li>1. If products are used beyond the range of the recommended conditions, heat stresses may deform the products, and consequently degrade the reliability of the products.</li> </ol> </li> </ul> <div style="display: flex; justify-content: space-around;"> <div style="text-align: center;"> <p>• BRC1608, BRL2012, BRL2518, BRC2016, BRL3225 Type BRC2518, BRFL2518 Recommended reflow condition (Pb free solder)</p> </div> <div style="text-align: center;"> <p>• NR30/40/50/60/80, NRV30, NRG40, NRH24/30, NRS50/60 Type Recommended reflow condition (Pb free solder)</p> </div> <div style="text-align: center;"> <p>• NR10050 Type Recommended reflow condition (Pb free solder)</p> </div> </div>
5. Cleaning	
Precautions	<ul style="list-style-type: none"> <li>◆ Cleaning conditions               <ol style="list-style-type: none"> <li>1. Washing by supersonic waves shall be avoided.</li> </ol> </li> </ul>
Technical considerations	<ul style="list-style-type: none"> <li>◆ Cleaning conditions               <ol style="list-style-type: none"> <li>1. If washing by supersonic waves, supersonic waves may cause broken products.</li> </ol> </li> </ul>
6. Handling	
Precautions	<ul style="list-style-type: none"> <li>◆ Handling               <ol style="list-style-type: none"> <li>1. Keep the product away from all magnets and magnetic objects.</li> </ol> </li> <li>◆ Breakaway PC boards (splitting along perforations)               <ol style="list-style-type: none"> <li>1. When splitting the PC board after mounting product, care should be taken not to give any stresses of deflection or twisting to the board.</li> <li>2. Board separation should not be done manually, but by using the appropriate devices.</li> </ol> </li> <li>◆ Mechanical considerations               <ol style="list-style-type: none"> <li>1. Please do not give the product any excessive mechanical shocks.</li> <li>2. Please do not add any shock and power to a product in transportation.</li> </ol> </li> <li>◆ Pick-up pressure               <ol style="list-style-type: none"> <li>1. Please do not push to add any pressure to a winding part. Please do not give any shock and push into a ferrite core exposure part..</li> </ol> </li> <li>◆ Packing               <ol style="list-style-type: none"> <li>1. Please avoid accumulation of a packing box as much as possible.</li> </ol> </li> </ul>
Technical considerations	<ul style="list-style-type: none"> <li>◆ Breakaway PC boards (splitting along perforations)               <ol style="list-style-type: none"> <li>1. Planning pattern configurations and the position of products should be carefully performed to minimize stress.</li> </ol> </li> <li>◆ Mechanical considerations               <ol style="list-style-type: none"> <li>1. There is a case to be damaged by a mechanical shock.</li> <li>2. There is a case to be broken by the handling in transportation.</li> </ol> </li> <li>◆ Pick-up pressure               <ol style="list-style-type: none"> <li>1. Damage and a characteristic can vary with an excessive shock or stress.</li> </ol> </li> <li>◆ Packing               <ol style="list-style-type: none"> <li>1. There is a case that transformation and a product of tape are damaged by accumulation of a packing box.</li> </ol> </li> </ul>
7. Storage conditions	
Precautions	<ul style="list-style-type: none"> <li>◆ Storage               <ol style="list-style-type: none"> <li>1. To maintain the solderability of terminal electrodes and to keep the packing material in good condition, temperature and humidity in the storage area should be controlled.                   <ul style="list-style-type: none"> <li>• Recommended conditions</li> <li>Ambient temperature: 0~40°C</li> <li>Humidity : Below 70% RH</li> </ul> </li> </ol> <p>The ambient temperature must be kept below 30°C. Even under ideal storage conditions, solderability of products electrodes may decrease as time passes. For this reason, product should be used within 6 months from the time of delivery. In case of storage over 6 months, solderability shall be checked before actual usage.</p> </li> </ul>
Technical considerations	<ul style="list-style-type: none"> <li>◆ Storage               <ol style="list-style-type: none"> <li>1. Under a high temperature and humidity environment, problems such as reduced solderability caused by oxidation of terminal electrodes and deterioration of taping/packaging materials may take place.</li> </ol> </li> </ul>

\* This catalog contains the typical specification only due to the limitation of space. When you consider purchase of our products, please check our specification. For details of each product (characteristics graph, reliability information, precautions for use, and so on), see our Web site (<http://www.ty-top.com/>) or CD catalogs.