

Features

- ◆ Low Series Resistance
- ◆ Low Capacitance
- ◆ Fast Switching Speed
- ◆ Silicon Nitride Passivation
- ◆ Polymer Scratch Protection
- ◆ RoHS Compliant

Description

M/A-COM Technology Solutions MA4FCP200 is a silicon flip chip PIN diode fabricated using a patented HMIC process which provides for repeatable electrical characteristics. This diode is fabricated on epitaxial wafers using a process designed for extremely low parasitics. The diode is fully passivated with silicon nitride to minimize leakage current. The chip also has an additional polymer layer for impact and scratch protection to prevent damage to the active area during handling.

Applications

The small outline and low 0.05pS RC product, make the device useful in multi-throw switches and switched phase shifter circuits requiring <20nS switching speeds at operating frequencies up to 18GHz.

1264 Outline

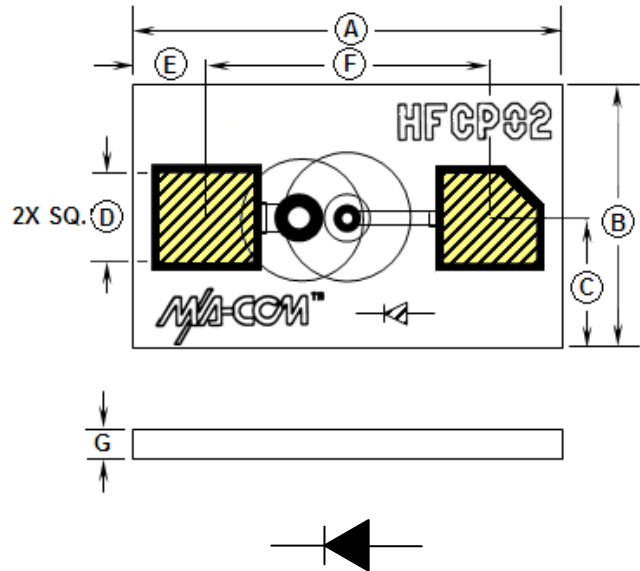

- Backside metal contacts: 0.1µM thick gold.
- Yellow hatched areas indicate backside, mounting, ohmic, gold contacts.

Absolute Maximum Ratings¹

$T_{AMB} = +25^{\circ}\text{C}$ (unless otherwise specified)

Parameter	Absolute Maximum
Forward Current	100mA
Reverse Voltage	- 70V
Operating Temperature	- 55°C to + 125°C
Storage Temperature	- 55°C to + 150°C
Dissipated Power	100mW
Mounting Temperature	+300°C for 10 seconds

Dim.	Inches		Millimeters	
	Min.	Max.	Min.	Max.
A	0.014	0.015	0.356	0.381
B	0.008	0.009	0.203	0.229
C	0.004	0.005	0.102	0.127
D	0.003	0.004	0.076	0.102
E	0.002	0.003	0.175	0.225
F	0.008	0.010	0.203	0.254
G	0.004	0.006	0.102	0.152

1. Exceeding any of these limits may cause permanent damage to the chip.

1

ADVANCED: Data Sheets contain information regarding a product M/A-COM Technology Solutions is considering for development. Performance is based on target specifications, simulated results, and/or prototype measurements. Commitment to develop is not guaranteed.
PRELIMINARY: Data Sheets contain information regarding a product M/A-COM Technology Solutions has under development. Performance is based on engineering tests. Specifications are typical. Mechanical outline has been fixed. Engineering samples and/or test data may be available. Commitment to produce in volume is not guaranteed.

• **North America** Tel: 800.366.2266 • **Europe** Tel: +353.21.244.6400
 • **India** Tel: +91.80.43537383 • **China** Tel: +86.21.2407.1588
 Visit www.macontech.com for additional data sheets and product information.

M/A-COM Technology Solutions Inc. and its affiliates reserve the right to make changes to the product(s) or information contained herein without notice.

Electrical Specifications @ T_{AMB} +25°C

Parameters @ Conditions	Symbol	Units	Min.	Typ.	Max.
Total Capacitance @ -40V, 1MHz ¹	C _T	pF	—	0.025	0.030
Total Capacitance @ -40V, 1GHz ^{1,3}	C _T	pF	—	0.020	—
Series Resistance @ +50mA ^{2,3} , 100MHz	R _S	Ω	—	2.4	3.0
Series Resistance @ +50mA ^{2,3} , 1GHz	R _S	Ω	—	2.8	—
Forward Voltage @ +100mA	V _F	V	—	1.25	1.5
Reverse Voltage @ -10μA	V _R	V	50	—	—
Reverse Current @ -50V	I _R	μA	—	—	10
Lifetime @ I _F = +10mA / I _{REV} = -6mA	T _L	nS	—	100	—
Steady State Thermal Resistance ⁴	θ	°C/W	—	900	—

1. Total capacitance is equivalent to the sum of junction capacitance, C_j, plus the die parasitic capacitance, C_p.
2. The series resistance, R_S, is equal to the total diode resistance which also includes the resistance of the junction, R_j.
3. R_s and C_p measured on an HP4291A with die mounted in an ODS-186 package.
4. Steady-state Thermal Resistance measured with die mounted in an ODS-186 package.

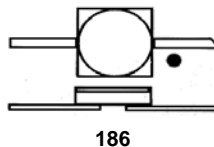

ESD

These devices very susceptible to ESD and are rated Class 0 (0-199V) per HBM MIL-STD-883, method 3015.7 [C = 100pF ±10%, R = 1.5kW ±1%]. Even though tested die pass 100V ESD, they must be handled in a static-free environment.

Specifications Subject to Change Without Notice.

2

ADVANCED: Data Sheets contain information regarding a product M/A-COM Technology Solutions is considering for development. Performance is based on target specifications, simulated results, and/or prototype measurements. Commitment to develop is not guaranteed.
PRELIMINARY: Data Sheets contain information regarding a product M/A-COM Technology Solutions has under development. Performance is based on engineering tests. Specifications are typical. Mechanical outline has been fixed. Engineering samples and/or test data may be available. Commitment to produce in volume is not guaranteed.

• **North America** Tel: 800.366.2266 • **Europe** Tel: +353.21.244.6400
 • **India** Tel: +91.80.43537383 • **China** Tel: +86.21.2407.1588
 Visit www.macomtech.com for additional data sheets and product information.

M/A-COM Technology Solutions Inc. and its affiliates reserve the right to make changes to the product(s) or information contained herein without notice.

Typical Performance @ $T_{AMB} +25^{\circ}C$

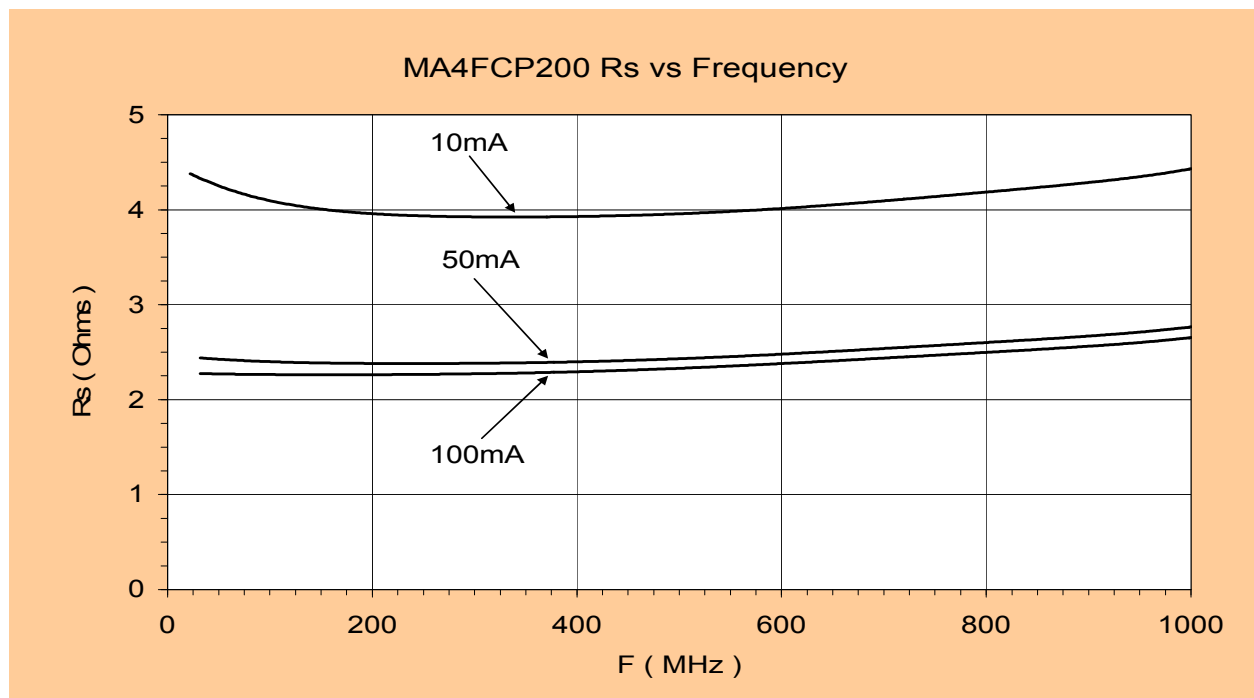
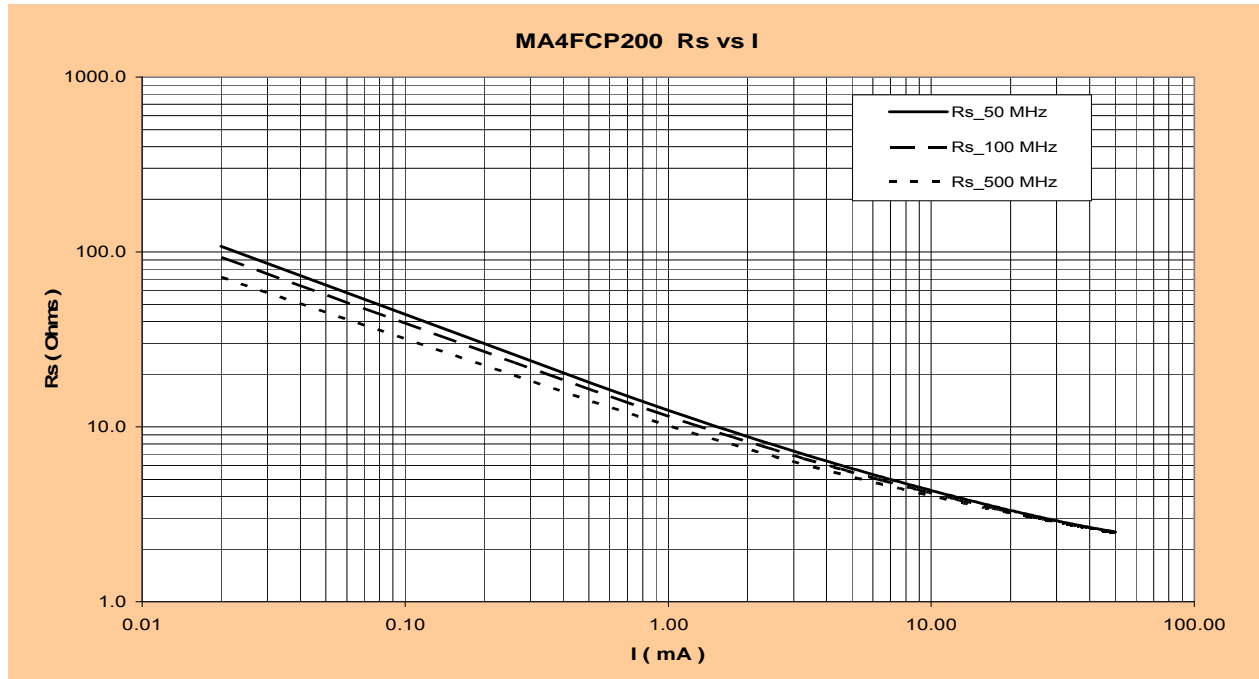

Typical Performance @ $T_{AMB} +25^{\circ}C$

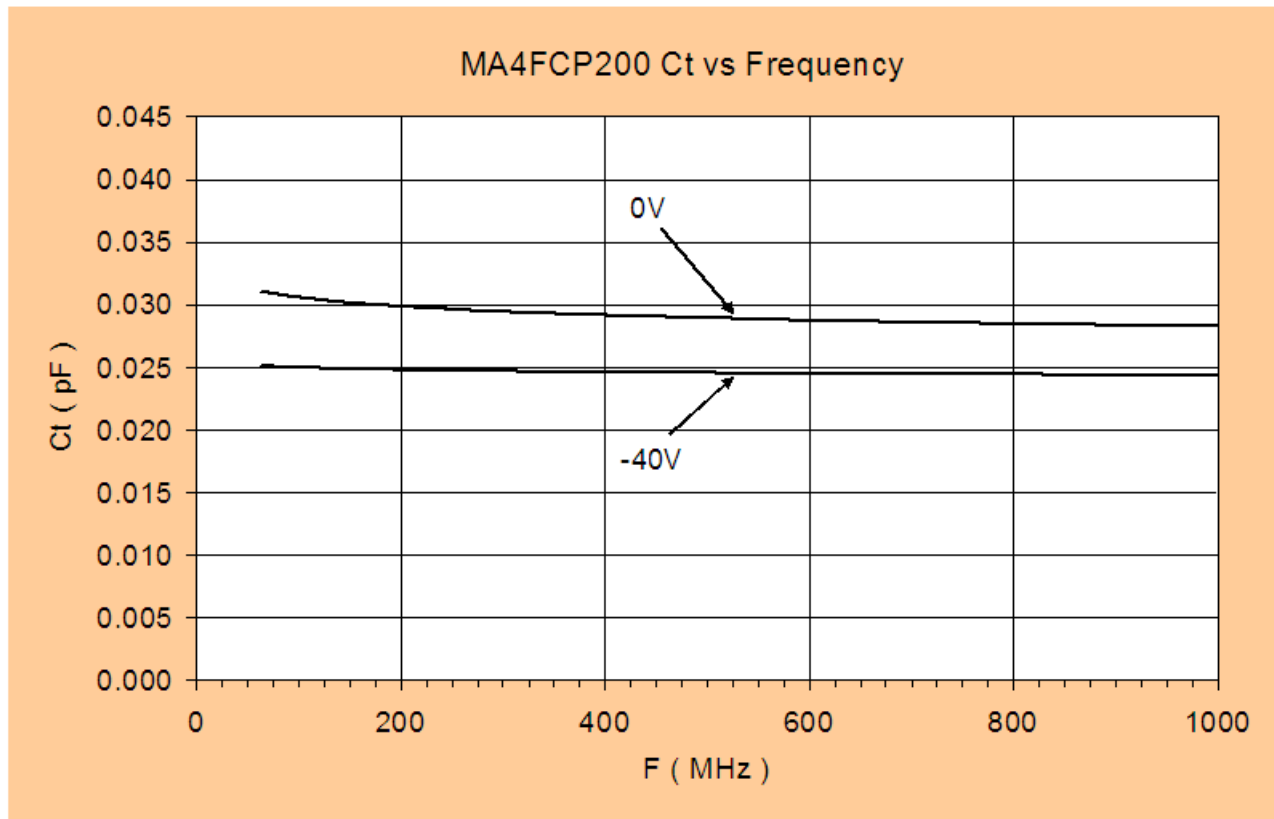

MA4FCP200 SPICE Model

PinDiodeModel

NLPINM1

Is=1.0E-14 A

wBv= 70 V

Vi=0.0 V

wPmax= 100 mW

Un= 900 cm²/V-sec

Ffe= 1.0

Wi= 5.0 um

Rr= 10 K Ohms

Cjmin= 0.02 pF

Tau= 0.10 usec

Rs(I)= Rc + Rj(I) = 0.05 Ohm + Rj(I)

Cj0= 0.03 pF

Vj= 0.7 V

M= 0.5

Fc= 0.5

Imax= 1.0 E+5 A/m²

Kf=0.0

Af=1.0

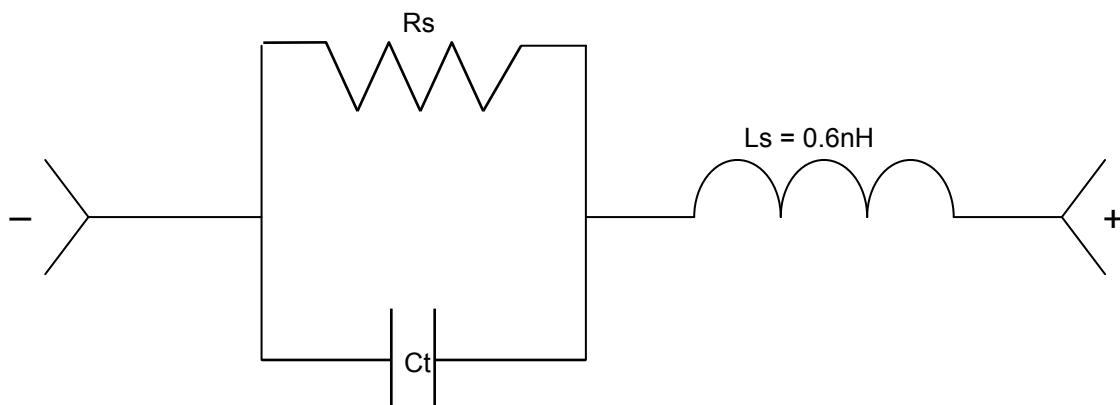

Handling Procedures

All semiconductor chips should be handled with care to avoid damage or contamination from perspiration and skin oils. The use of plastic tipped tweezers or vacuum pickups is strongly recommended for individual components. Bulk handling should insure that abrasion and mechanical shock are minimized.

Bonding Techniques

These devices were designed for insertion onto hard or soft substrates with the junction side down. They can be mounted with electrically conductive epoxy or with a eutectic solder preform. However, tin rich solders will scavenge gold from the bottom contacts and are not recommended. Indalloy or 80/20, Au/Sn, solders are acceptable. Maximum soldering temperature must be <300°C for <10 sec. These chips are designed to be inserted onto hard or soft substrates with the junction side down. They should be mounted onto silkscreened circuits using electrically conductive Ag epoxy, approximately 1-2 mils in thickness and cured at approximately 90°C to 150°C per manufacturer's schedule. For extended cure times, >30 minutes, temperatures must be kept below 200°C. The die can also be assembled using non conductive epoxy with the junction side up, and wire or ribbon bonds made to the pads.

Circuit Mounting Dimensions (Inches)

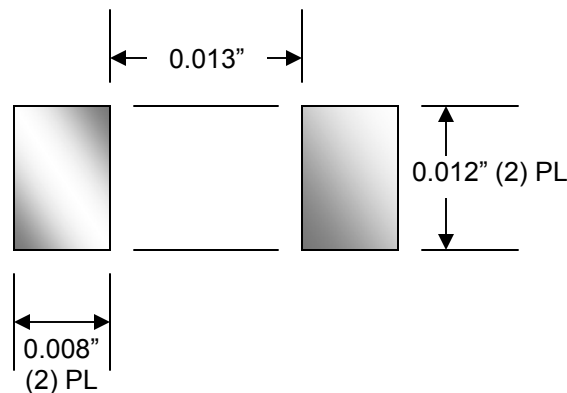

Ordering Information

Part Number	Packaging
MA4FCP200	Die in Gel Pack
MA4FCP200-W	Wafer Cut on Tape