



# PRODUCT SPECIFICATION

**Model No : CSPR-U30AHR4-A0R**

Descriptions:	
■ LED Type	: Superbright Lamp
■ LED Package	: Piranha LED Lamp
■ Emitting Color	: Red
■ Viewing Angle	: 60°
■ Stopper	



CUSTOMER APPROVED SIGNATURES	APPROVED BY	CHECKED BY	PREPARED BY

**CHINA SEMICONDUCTOR CORPORATION**  
Address:2FL. NO.909,Chung-Cheng Road,  
Chung-Ho City Taipei Hsien,Taiwan.

Tel:886-2-2223-9696  
Fax:886-2-2223-9377

**OPTO PLUS TECHNOLOGIES CO.,LTD**  
Address:696 Shun jiang Rd.,Ji Shan St.Shaoxing,  
ZheJiang,China

Tel:86-0575-88623888  
Fax:86-0575-88623112



Spec. No.	PS-LU-U30AHR4-A0R
Rev.	A

**Model No : CSPR-U30AHR4-A0R**

**■ Features -**

1. High Current Operation
2. High Luminous Output
3. High Reliability and Solid Performance
4. Optimal Optical/Mechanical Design
5. Packaged in Tubes for Use with Automatic Pick and Place Equipment
6. Rohs Compliant

**■ Device Selection Guide -**

Part No.	Chip		LED Lens
	Material	Emitted Color	
CSPR-U30AHR4-A0R	AllnGaP	Red	Water Transparent

**■ Package Outline Dimensions -**

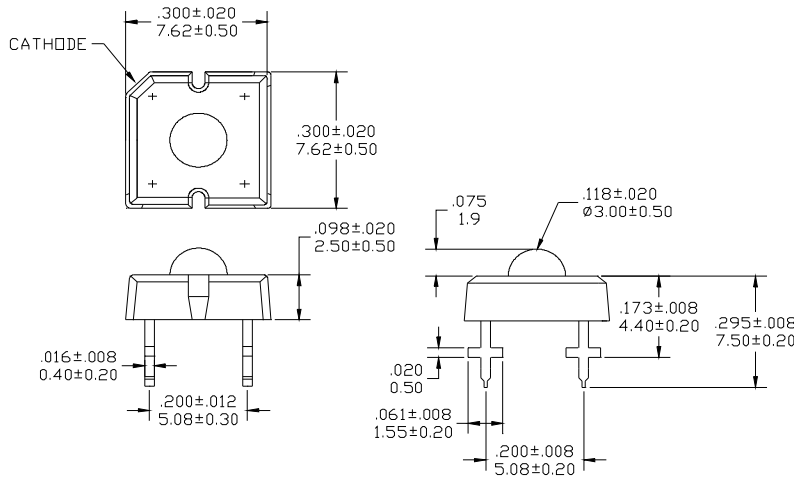

\* Tolerance :  $\pm \frac{0.01}{0.25}$  Unit :  $\pm \frac{\text{inch}}{\text{mm}}$



Model No : CSPR-U30AHR4-A0R

■ Absolute Maximum Rating -

(Ta=25°C)

Parameter	Symbol	Rating	Unit
Power Dissipation	Pd	196	mW
Forward Current (DC)	IF	70	mA
Peak Forward Current *	IFP	100	mA
Reverse Voltage	VR	5	V
Operating Temp.	Topr	-30 ~ +80	°C
Storage Temp.	Tstg	-40 ~ +100	°C
Lead Soldering Temperature	Tsol	Max. 260°C for 5 sec Max. (3mm from the epoxy bulb)	

\* Pulse width  $\leq 0.1$  msec. duty  $\leq 1/10$

■ Electro-optical Characteristics -

(Ta=25°C)

Parameter	Symbol	Min.	Typ.	Max.	Unit	Condition
Forward Voltage	VF	-----	2.3	2.8	V	IF=70mA
Luminous Intensity	Iv	6600	13000	-----	mcd	
Luminous Flux	$\Phi v$	6000	8000	-----	mlm	
Dominant Wavelength	$\lambda d$	-----	615	-----	nm	
Peak Wavelength	$\lambda p$	-----	625	-----	nm	
Viewing Angle	$2\theta$ 1/2	-----	60	-----	deg	
Reverse Current	IR	-----	-----	100	$\mu A$	VR=5V



■ Luminous Flux Rank Limits (  $I_F = 70\text{mA}$  )

unit : mlm

Part No Code	CSPR-U30AHR4-A0R	
	min.	max.
D	2000	2500
E	2500	3000
F	3000	3500
G	3500	4000
H	4000	5000

■ Dominant Wavelength Rank Limits (  $I_F = 70\text{mA}$  )

unit : nm

Part No Code	CSPR-U30AHR4-A0R	
	min.	max.
A5	612	616
A6	616	620
R1	620	625
R2	625	630

■ Forward Voltage Rank Limits (  $I_F = 70\text{mA}$  )

unit : v

Part No Code	CSPR-U30AHR4-A0R	
	min.	max.
C	1.8	2.0
D	2.0	2.2
E	2.2	2.4
F	2.4	2.6
G	2.6	2.8

Notes:

1. Tolerance of measurement of luminous Flux  $\pm 15\%$
2. Tolerance of measurement of dominant wavelength  $\pm 2\text{nm}$
3. Tolerance of measurement of forward voltage  $\pm 0.05\text{v}$
4. All data are measured by CSC's test equipment.
5. One delivery will include several color rank, VF rank and  $I_v$  ranks of the products.
6. The quantity-ratio of the ranks is decided by CSC.
7. Please confirm with CSC salesman, if your request different from standard specification.



Model No : CSPR-U30AHR4-A0R

■ Typical Electrical / Optical Characteristics Curves -

(Ta = 25°C Unless Otherwise Noted)

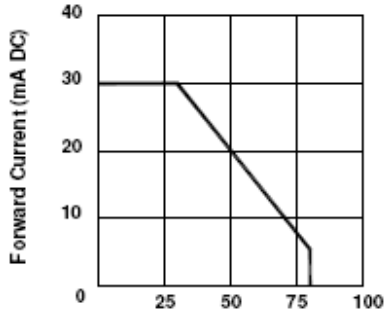

Ambient Temperature Ta (°C)  
Fig 1. Forward Current  
Vs. Ambient Temperature

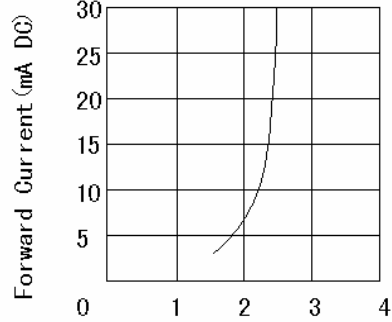

Forward Voltage VF (V)  
Fig. 2 Forward Current  
Vs. Forward Voltage

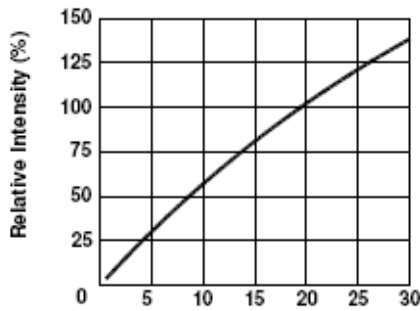

Forward Current IF (mA DC)  
Fig 3. Relative Intensity  
Vs. Forward Current

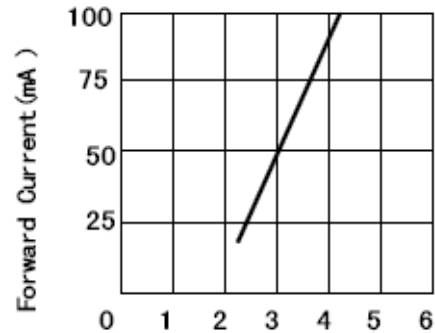

Forward Voltage (V)  
Fig. 4 Peak Forward Voltage  
Vs. Forward Current  
(100us test pulse, 1% duty cycle)

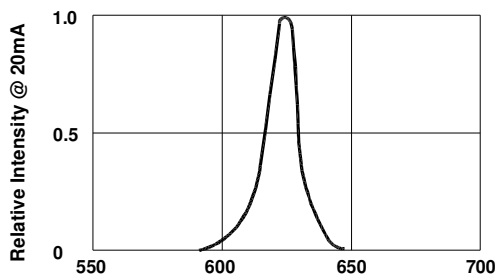

Fig 5. Relative Intensity Vs. Wavelength

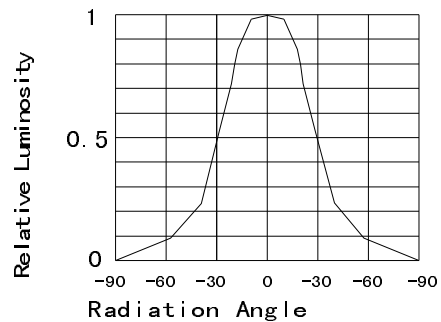

Fig 6. Relative Luminous Intensity vs. Radiation Angle



Model No : CSPR-U30AHR4-A0R

## ■ Precautions For Use -

### 1. Recommended Soldering conditions

#### Wave Soldering

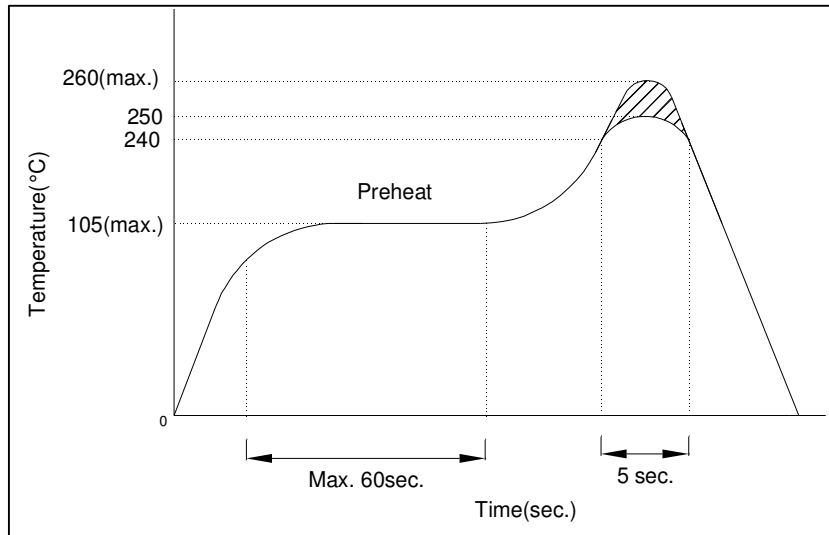

### 2. Soldering Iron

Basic SPEC. is  $\leq 5\text{sec.}$  When  $260^{\circ}\text{C}$ . If temperature is higher, time should be shorter ( $+10^{\circ}\text{C} \rightarrow -1\text{sec.}$ ). Power dissipation of iron should be smaller than 15W, and temperature should be controllable. Surface temperature of the device should be under  $230^{\circ}\text{C}$ .

### 3. Static Electricity

- a. Static electricity or surge voltage damages LEDs..

It is recommended that a wrist band or an anti-electrostatic glove be used when handling the LEDs.

- b. All devices, equipment and machinery must be properly grounded. It is recommended that measures be taken against surge voltage to the equipment that mounts the LEDs.

Note: The specifications are subject to change without notice. Please contact us for updated information.