



===== **CONTENTS** =====

1. INTRODUCTION.....	3
2. FEATURES	3
3. PIN ASSIGNMENT.....	4
4. BLOCK DIAGRAM.....	4
5. FUNCTION DESCRIPTIONS	5
5.1 OSCILLATOR	5
5.2 ROM	5
5.3 RAM	6
5.4 POWER DOWN MODE.....	6
5.5 SAMPLING RATE COUNTER	6
5.6 I/O PORTS	6
5.7 PWM OUTPUT	7
5.8 WATCH DOG TIMER.....	7
5.9 IR FUNCTION	7
5.10 PWM IO CONTROL	7
6. ABSOLUTE MAXIMUM RATING	7
7. ELECTRICAL CHARACTERISTICS	8
8. APPLICATION CIRCUIT	9
8.1 GENERAL APPLICATION	9
8.2 MOTOR APPLICATION	10



AMENDENT HISTORY

Version	Date	Description
Ver 1.0	Nov. 6, 2008	First issue
Ver 1.1	Nov. 17, 2008	Revise CVDD & VDDIO order of "Motor Application"
Ver 1.2	Jan. 7, 2009	Revise SRAM information
Ver 1.3	Feb. 13, 2009	1. Revise Rosc=220K Ohm in Application Circuit part
Ver 1.4	May 6, 2009	1. Revise frequency guarantee range in electrical characteristics according IC Test flow
Ver 1.5	June 23, 2009	No modification, just revise version following with updating SNC26500 IO numbers.
Ver 1.6	July 23, 2009	Revise system clock with 2.05MHz (typical).
Ver 1.7	October 14, 2009	1. Revise PWM output spec condition with BUOx=1/2 VDD (peak value), instead of 1KHz sine wave

1. INTRODUCTION

SNC26040 is a one-channel voice synthesizer IC with PWM direct drive circuit. It built in a 4-bit tiny controller with two 4-bit I/O ports. By programming through the tiny controller in SNC26040, user's varied applications including voice section combination, key trigger arrangement, output control, and other logic functions can be easily implemented.

2. FEATURES

- ◆ Single power supply 2.4V – 5.5V
- ◆ 40 seconds voice capacity are provided (@6KHZ sample rate)
- ◆ Built in a 4-bit tiny controller
- ◆ I/O Port
 - Two 4-bit I/O ports P2 and P3 are provided.
 - The driving/sink current of P2 & P3 is up to 8mA/16mA
 - The IO pins P2.3 can be modulated with 38.5Khz carry signal to implement IR function.
 - PWM output for IO (P2.0~P2.3, P3.0~P3.3)
- ◆ (64+16)*4 bits RAM are provided.
(Notes : m0~m63 + 16 PWMIO duty registers)
- ◆ Maximum 64K program ROM is provided
- ◆ 84K*12 shared ROM for voice data and program
- ◆ Readable ROM code data
- ◆ **Voice Synthesizer:**
 - **Single channel speech output.**
 - **Support 4-bits SONiX-ASDPCM and 8-bit PCM algorithm**
- ◆ Adaptive playing speed from 2.5k-20kHz is provided
- ◆ Built in an PWM circuit output, can directly connected to Speaker for sound output.
- ◆ System clock: 2MHz
- ◆ Event Mark function supported
- ◆ Low Power Detect.
- ◆ Watch Dog Timer Supported

3. PIN ASSIGNMENT

Symbol	I/O	Function Description
P20~P23	I/O	I/O port 2: IO
P30~P33	I/O	I/O port 3: IO
Rosc	I	Oscillation component connection pin
BUO1	O	PWM output 1
BUO2	O	PWM output 2
RST	I	RST=1 → Reset Chip (Active H)
CVDD	I	Positive power supply for CPU
CGND	I	Negative power supply for CPU
VDDIO	I	Positive power supply for I/O
GNDIO	I	Negative power supply for I/O
Test	I	Test pin

4. Block Diagram

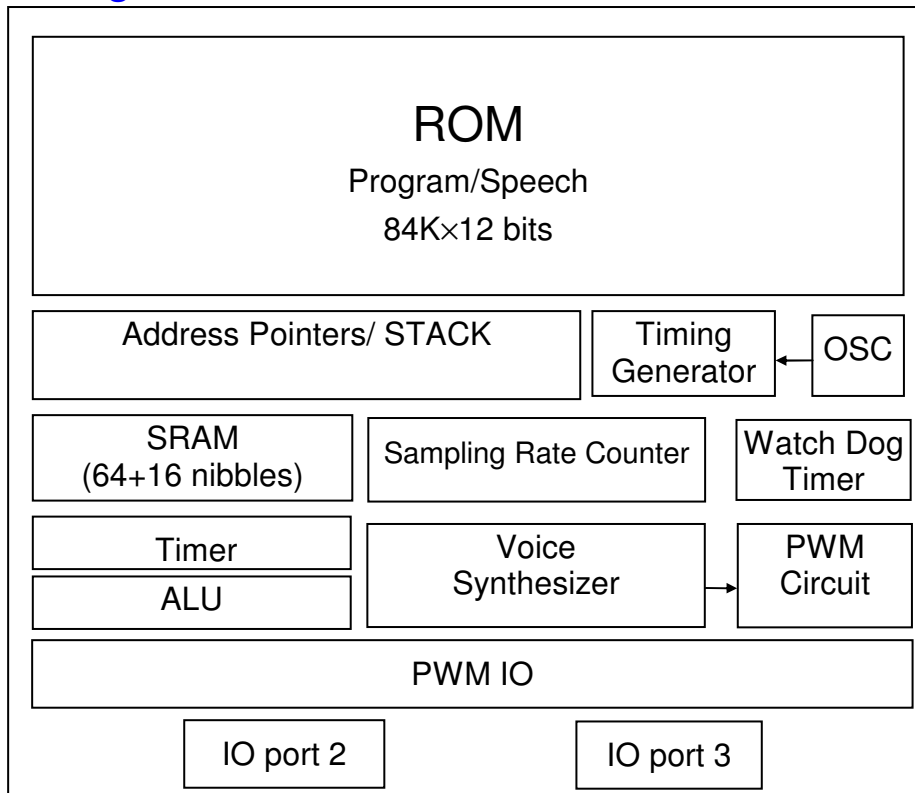

5. FUNCTION DESCRIPTIONS

5.1 Oscillator

SNC26040 accepts RC type oscillator for system clock. The typical circuit diagram for oscillator is listed as follows.

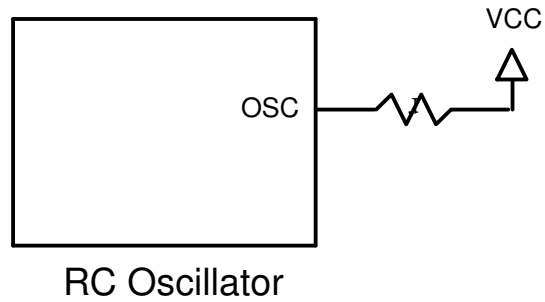

5.2 ROM

SNC26040 contains a substantial 84K words (12-bit) internal ROM, which is shared by program and resource data. Program, voice and data are shared within this same 84K words ROM.

5.3 RAM

SNC26040 contains (64+16) nibble RAM <(64+16) x 4-bits>. The 64 nibble RAM is only one page. Another 16 nibbles are 16 PWMIO duty registers. In our programming structure, user can Directly use memory related command, M0 ~ M63 in the data transfer type instructions, to access first 64 nibbles. Another 16 nibbles, user can use PWMxL, PWMxH related command to access when PWMIO function is disabled. (x can be 1~8)

5.4 Power Down Mode

“End” instruction makes the IC entering into Stop Mode will stop the system clock for power savings (<3uA @VDD=3V and <6uA @VDD=4.5V.) Any valid data transition (L→H or H→L) occurring on any IO pin can be used to start the system clock and return to normal operating mode.

5.5 Sampling Rate Counter

The unique sampling rate counter is designed in voice channel to be able to play diverse voices at different sample playing rates. The playing rate can be adaptively set up among from the wide ranges of 2.5KHz to 20KHz. This architecture yields a high-quality voice synthesis that sounds very close to its original source when played through the same amplifier and speaker circuitry.

5.6 I/O Ports

There are two 4-bit I/O ports P2 and P3. Any I/O can be individually programmed as either input pull low or output. Any valid data transition (H→ L or L→H) of P2 and P3 can reactivate the chip when it is in power-down stage.

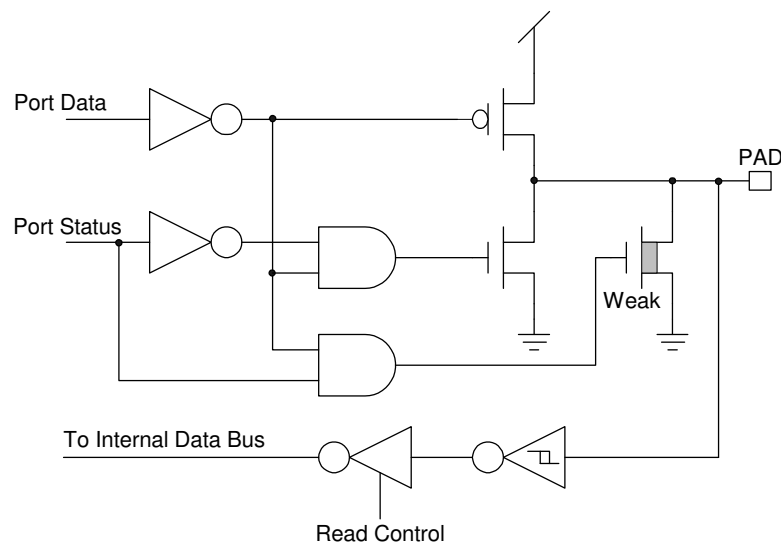

I/O Port Configuration

Note:

- (1) **Weak N-MOS can serve as pull-low resistor.**
- (2) **The driving/sink current of P2 & P3 is up to 8mA/16mA**

5.7 PWM Output

An PWM circuit is built-in SNC26040. The maximum resolution of PWM is 8 bits. Two huge output stage circuits are designed in SNC26040. With this advanced circuit, the chip is capable of driving speaker directly without external transistors.

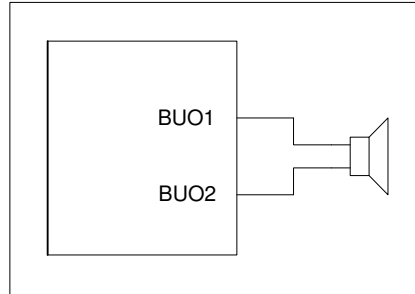

PWM Output

5.8 Watch Dog Timer

SNC26040 built an internal WDT (Watch Dog Timer). This Watchdog timer would issue resets signal to this chip if it is not cleared before reaching terminal count (128 ms). The watchdog timer is enabled at reset and cannot be disabled.

5.9 IR Function

P23 can be modulated with 38.5KHz square wave before sent out to P23 pin. The IR signal can be achieved by this modulated signal.

5.10 PWM IO control

SNC26040 has support 8 PWM IO (P20~P23, P30~P33). Each I/O has 8 bit independent duty register, and the 8 bit register are compare with 8 bits counter. If set use PWM IO function and internal counter start at 000H, the mapping I/O will set High. The 8 bits counter increment if the same duty register, that will reset the mapping IO pin.

6. ABSOLUTE MAXIMUM RATING

Items	Symbol	Min	Max	Unit.
Supply Voltage	$V_{DD}-V$	-0.3	6.0	V
Input Voltage	V_{IN}	$V_{SS}-0.3$	$V_{DD}+0.3$	V
Operating Temperature	T_{OP}	0	55.0	°C
Storage Temperature	T_{STG}	-55.0	125.0	°C

7. ELECTRICAL CHARACTERISTICS

Item	Sym.	Min.	Typ.	Max.	Unit	Condition
Operating Voltage	V _{DD}	2.4	3.0	5.5	V	
Standby current	I _{SBY}	-	-	3.0 6.0	μA	V _{DD} =3V, no load V _{DD} =4.5V, no load
Operating Current	I _{OPR}	-	300	-	μA	V _{DD} =3V, no load
Input current of P2, P3	I _{IH}	-	3.0	-	μA	V _{DD} =3V, V _{IN} =3V
Drive current of P2, P3	I _{OD}	6	8	-	mA	V _{DD} =3V, V _O =2.4V
Sink current of P2, P3	I _{OS}	10	16	-	mA	V _{DD} =3V, V _O =2.4V
PWM current	I _{PWM}	-	240	-	mA	V _{DD} =3V, BUOx=1.5V
PWM current	I _{PWM}	-	310	-	mA	V _{DD} =4.5V, BUOx=2.25V
Oscillation Freq.	F _{OSC}	1.98	2.05	2.12	MHz	V _{DD} =3V, Temp.=25°C @Rosc = 220 Kohm Min : -3% Max : +3%

8. APPLICATION Circuit

8.1 General application

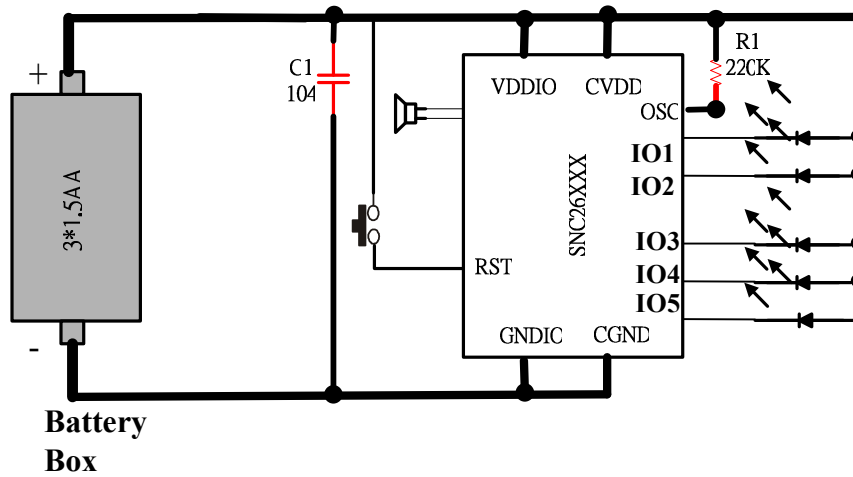

It is suggested to add a capacitor (C1), 104, between VDD with GND to keep power stable with general application. And this capacitor is strongly suggested to be as close to the chip as possible.

8.2 Motor application

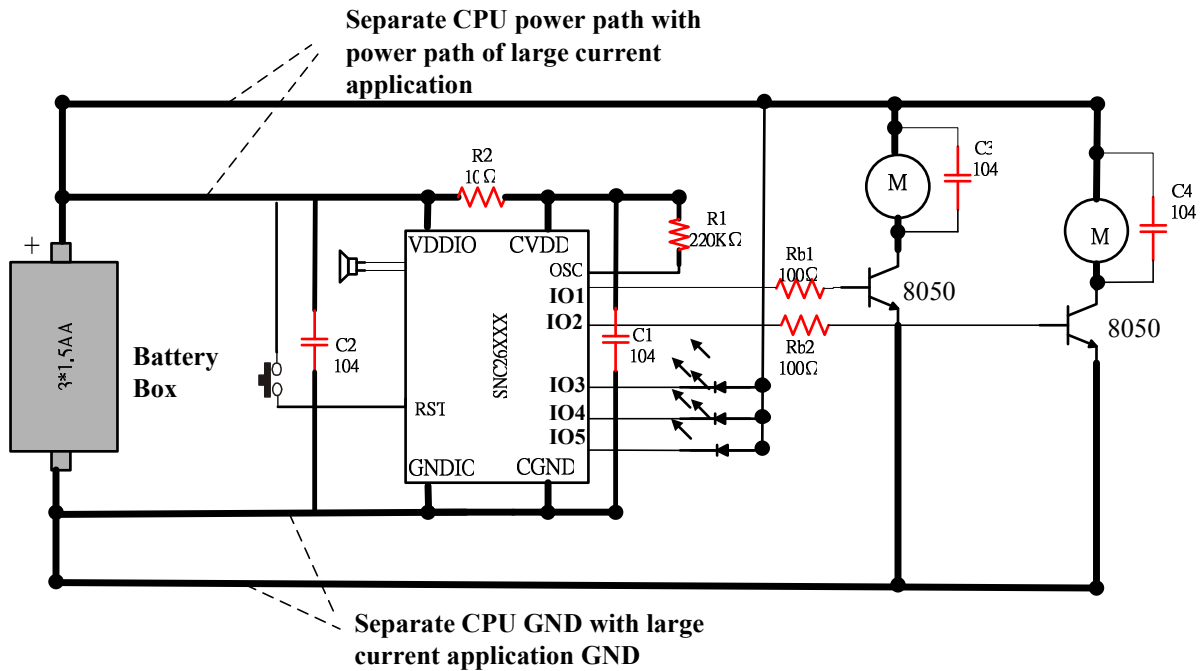

There are some suggestions about PCB layout when user use SNC26000 series IC with motor applications.

- (1) The capacitor C1 (104) C2 (104) is strongly suggested to be as close to the chip as possible.
- (2) It had better let OSC components (R) get close to IC chip.
- (3) OSC components had better get far away large current applications.
- (4) Separate IC power path with large current application power path to avoid affect IC working by power drop from large current application.
- (5) R2 (10Ω) separate VDDIO and CVDD.
- (6) Let power cable thicker, especially for large current application.
- (7) C3 and C4 (104) are connected at the positive point and negative point of the motor.

DISCLAIMER

The information appearing in SONiX web pages (“this publication”) is believed to be accurate.

However, this publication could contain technical inaccuracies or typographical errors. The reader should not assume that this publication is error-free or that it will be suitable for any particular purpose. SONiX makes no warranty, express, statutory implied or by description in this publication or other documents which are referenced by or linked to this publication. In no event shall SONiX be liable for any special, incidental, indirect or consequential damages of any kind, or any damages whatsoever, including, without limitation, those resulting from loss of use, data or profits, whether or not advised of the possibility of damage, and on any theory of liability, arising out of or in connection with the use or performance of this publication or other documents which are referenced by or linked to this publication.

This publication was developed for products offered in Taiwan. SONiX may not offer the products discussed in this document in other countries. Information is subject to change without notice. Please contact SONiX or its local representative for information on offerings available. Integrated circuits sold by SONiX are covered by the warranty and patent indemnification provisions stipulated in the terms of sale only. The application circuits illustrated in this document are for reference purposes only. SONiX DISCLAIMS ALL WARRANTIES, INCLUDING THE WARRANTY OF MERCHANTABILITY OR FITNESS FOR ANY PURPOSE. SONiX reserves the right to halt production or alter the specifications and prices, and discontinue marketing the Products listed at any time without notice. Accordingly, the reader is cautioned to verify that the data sheets and other information in this publication are current before placing orders.

Products described herein are intended for use in normal commercial applications. Applications involving unusual environmental or reliability requirements, e.g. military equipment or medical life support equipment, are specifically not recommended without additional processing by SONiX for such application.