



PH2525L

N-channel TrenchMOS logic level FET

Rev. 02 — 5 December 2006

Product data sheet

1. Product profile

1.1 General description

Logic level N-channel enhancement mode Field-Effect Transistor (FET) in a plastic package using TrenchMOS technology.

1.2 Features

- Logic level threshold
- Optimized for use in DC-to-DC converters
- 100 % R_G tested
- Lead-free package
- Very low switching and conduction losses

1.3 Applications

- DC-to-DC converters
- Voltage regulators
- Switched-mode power supplies
- PC Motherboards

1.4 Quick reference data

- V_{DS} ≤ 25 V
- R_{DSon} ≤ 2.5 mΩ
- I_D ≤ 100 A
- Q_{GD} = 6.8 nC (typ)

2. Pinning information

Table 1. Pinning

Pin	Description	Simplified outline	Symbol
1, 2, 3	source (S)	<p>SOT669 (LFAK)</p>	<p>mbb076</p>
4	gate (G)		
mb	mounting base; connected to drain (D)		

3. Ordering information

Table 2. Ordering information

Type number	Package		Version
	Name	Description	
PH2525L	LFPK	plastic single-ended surface-mounted package; 4 leads	SOT669

4. Limiting values

Table 3. Limiting values

In accordance with the Absolute Maximum Rating System (IEC 60134).

Symbol	Parameter	Conditions	Min	Max	Unit
V_{DS}	drain-source voltage	$25\text{ °C} \leq T_j \leq 150\text{ °C}$	-	25	V
V_{DGR}	drain-gate voltage (DC)	$25\text{ °C} \leq T_j \leq 150\text{ °C}$; $R_{GS} = 20\text{ k}\Omega$	-	25	V
V_{GS}	gate-source voltage		-	± 20	V
I_D	drain current	$T_{mb} = 25\text{ °C}$; $V_{GS} = 10\text{ V}$; see Figure 2 and 3	-	100	A
		$T_{mb} = 100\text{ °C}$; $V_{GS} = 10\text{ V}$; see Figure 2	-	76.7	A
I_{DM}	peak drain current	$T_{mb} = 25\text{ °C}$; pulsed; $t_p \leq 10\text{ }\mu\text{s}$; see Figure 3	-	300	A
P_{tot}	total power dissipation	$T_{mb} = 25\text{ °C}$; see Figure 1	-	62.5	W
T_{stg}	storage temperature		-55	+150	°C
T_j	junction temperature		-55	+150	°C
Source-drain diode					
I_S	source current	$T_{mb} = 25\text{ °C}$	-	52	A
I_{SM}	peak source current	$T_{mb} = 25\text{ °C}$; pulsed; $t_p \leq 10\text{ }\mu\text{s}$	-	208	A
Avalanche ruggedness					
$E_{DS(AL)S}$	non-repetitive drain-source avalanche energy	unclamped inductive load; $I_D = 80\text{ A}$; $t_p = 0.22\text{ ms}$; $V_{DS} \leq 25\text{ V}$; $R_{GS} = 50\text{ }\Omega$; $V_{GS} = 10\text{ V}$; starting at $T_j = 25\text{ °C}$	-	320	mJ

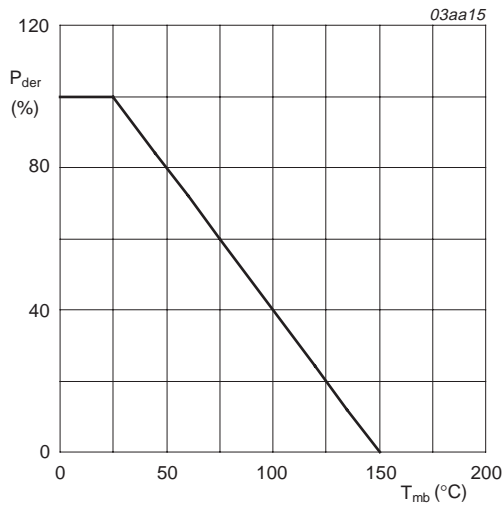

$$P_{der} = \frac{P_{tot}}{P_{tot(25^{\circ}C)}} \times 100\%$$

Fig 1. Normalized total power dissipation as a function of mounting base temperature

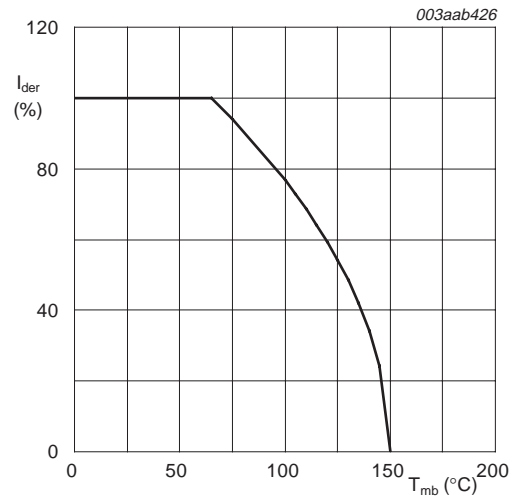

$$I_{der} = \frac{I_D}{I_{D(25^{\circ}C)}} \times 100\%$$

Fig 2. Normalized continuous drain current as a function of mounting base temperature

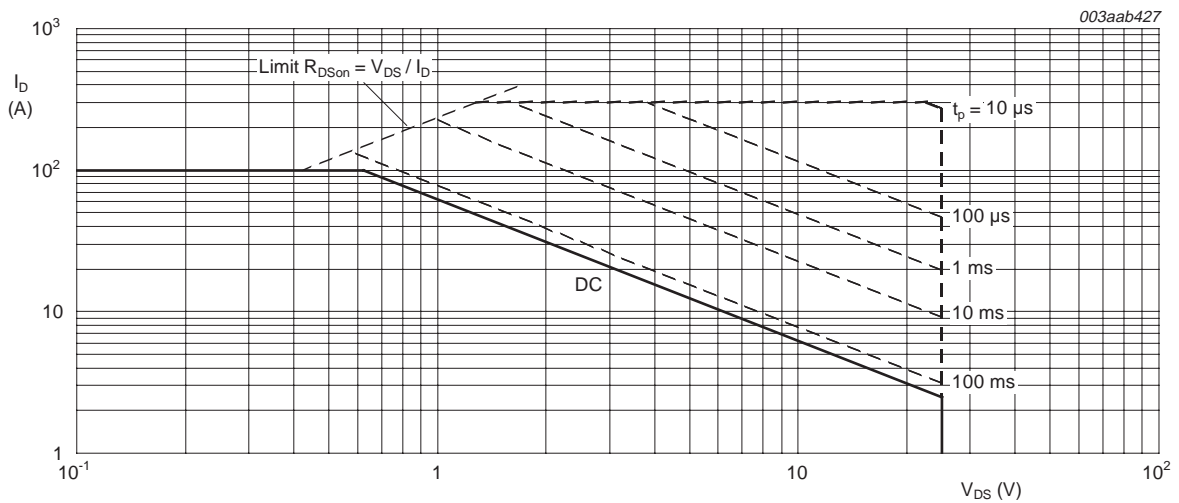

T_{mb} = 25 °C; I_{DM} is single pulse

Fig 3. Safe operating area; continuous and peak drain currents as a function of drain-source voltage

5. Thermal characteristics

Table 4. Thermal characteristics

Symbol	Parameter	Conditions	Min	Typ	Max	Unit
$R_{th(j-mb)}$	thermal resistance from junction to mounting base	see Figure 4	-	-	2	K/W

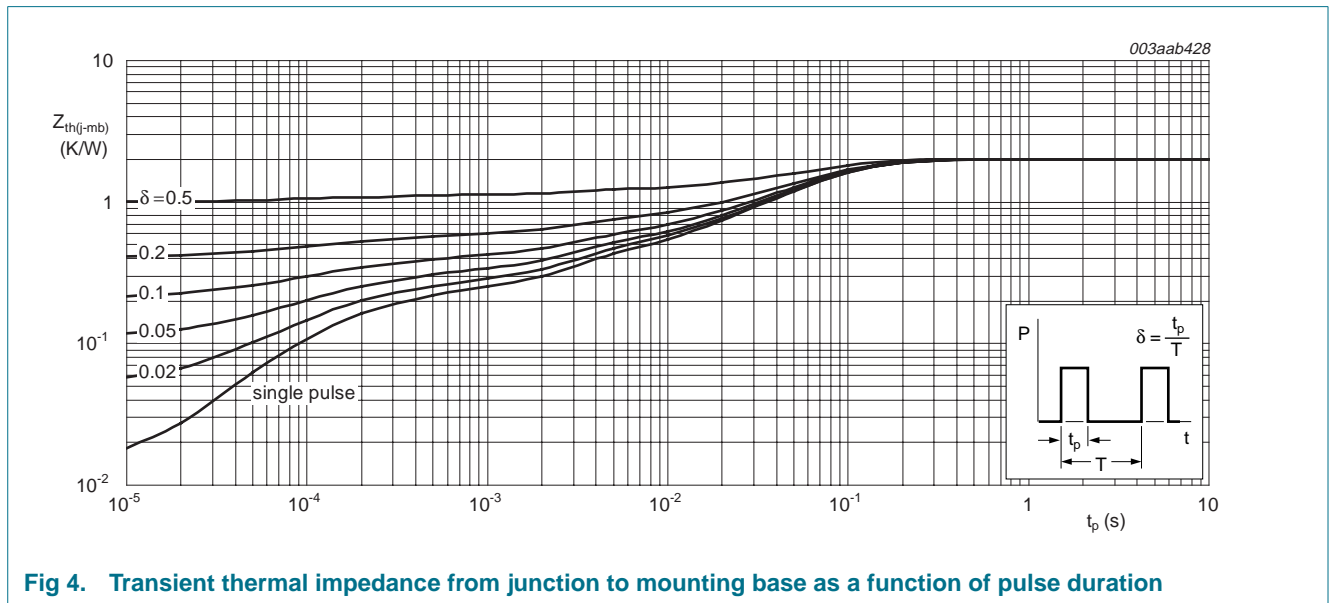
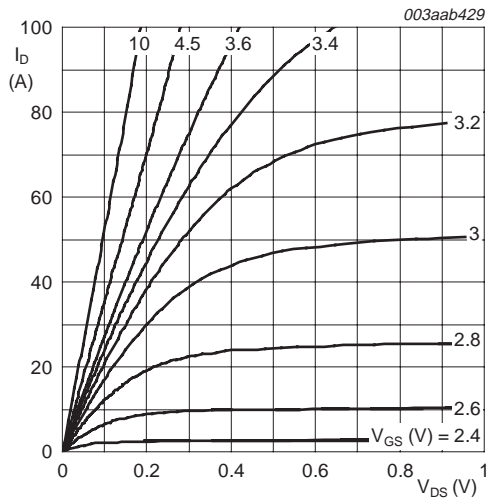

Fig 4. Transient thermal impedance from junction to mounting base as a function of pulse duration

6. Characteristics

Table 5. Characteristics
 $T_j = 25\text{ °C}$ unless otherwise specified.

Symbol	Parameter	Conditions	Min	Typ	Max	Unit
Static characteristics						
$V_{(BR)DSS}$	drain-source breakdown voltage	$I_D = 250\ \mu\text{A}$; $V_{GS} = 0\ \text{V}$ $T_j = 25\text{ °C}$	25	-	-	V
		$T_j = -55\text{ °C}$	22.5	-	-	V
$V_{GS(th)}$	gate-source threshold voltage	$I_D = 1\ \text{mA}$; $V_{DS} = V_{GS}$; see Figure 9 and 10 $T_j = 25\text{ °C}$	1.3	1.7	2.15	V
		$T_j = 150\text{ °C}$	0.8	-	-	V
		$T_j = -55\text{ °C}$	-	-	2.6	V
I_{DSS}	drain leakage current	$V_{DS} = 25\ \text{V}$; $V_{GS} = 0\ \text{V}$ $T_j = 25\text{ °C}$	-	-	1	μA
		$T_j = 150\text{ °C}$	-	-	100	μA
I_{GSS}	gate leakage current	$V_{GS} = \pm 16\ \text{V}$; $V_{DS} = 0\ \text{V}$	-	-	100	nA
R_G	gate resistance	$f = 1\ \text{MHz}$	-	0.7	-	Ω
$R_{DS(on)}$	drain-source on-state resistance	$V_{GS} = 10\ \text{V}$; $I_D = 25\ \text{A}$; see Figure 6 and 8 $T_j = 25\text{ °C}$	-	1.8	2.5	m Ω
		$T_j = 150\text{ °C}$	-	3.1	4.25	m Ω
		$V_{GS} = 4.5\ \text{V}$; $I_D = 25\ \text{A}$; see Figure 6 and 8	-	2.6	3.9	m Ω
Dynamic characteristics						
$Q_{G(tot)}$	total gate charge	$I_D = 25\ \text{A}$; $V_{DS} = 12\ \text{V}$; $V_{GS} = 4.5\ \text{V}$; see Figure 11 and 12	-	34.7	-	nC
Q_{GS}	gate-source charge		-	14.4	-	nC
Q_{GS1}	pre- $V_{GS(th)}$ gate-source charge		-	7.2	-	nC
Q_{GS2}	post- $V_{GS(th)}$ gate-source charge		-	7.2	-	nC
Q_{GD}	gate-drain charge		-	6.8	-	nC
$V_{GS(pl)}$	gate-source plateau voltage		-	2.9	-	V
$Q_{G(tot)}$	total gate charge	$I_D = 0\ \text{A}$; $V_{DS} = 0\ \text{V}$; $V_{GS} = 4.5\ \text{V}$	-	27.6	-	nC
C_{iss}	input capacitance	$V_{GS} = 0\ \text{V}$; $V_{DS} = 12\ \text{V}$; $f = 1\ \text{MHz}$; see Figure 14	-	4470	-	pF
C_{oss}	output capacitance		-	1070	-	pF
C_{riss}	reverse transfer capacitance		-	470	-	pF
C_{iss}	input capacitance	$V_{GS} = 0\ \text{V}$; $V_{DS} = 0\ \text{V}$; $f = 1\ \text{MHz}$	-	5120	-	pF
$t_{d(on)}$	turn-on delay time	$V_{DS} = 12\ \text{V}$; $R_L = 0.5\ \Omega$; $V_{GS} = 4.5\ \text{V}$; $R_G = 5.6\ \Omega$	-	41	-	ns
t_r	rise time		-	92	-	ns
$t_{d(off)}$	turn-off delay time		-	53	-	ns
t_f	fall time		-	37	-	ns
Source-drain diode						
V_{SD}	source-drain voltage	$I_S = 25\ \text{A}$; $V_{GS} = 0\ \text{V}$; see Figure 13	-	0.77	1.2	V
t_{rr}	reverse recovery time	$I_S = 20\ \text{A}$; $di_S/dt = -100\ \text{A}/\mu\text{s}$; $V_{GS} = 0\ \text{V}$	-	50	-	ns
Q_r	recovered charge		-	22	-	nC



T_j = 25 °C

Fig 5. Output characteristics: drain current as a function of drain-source voltage; typical values

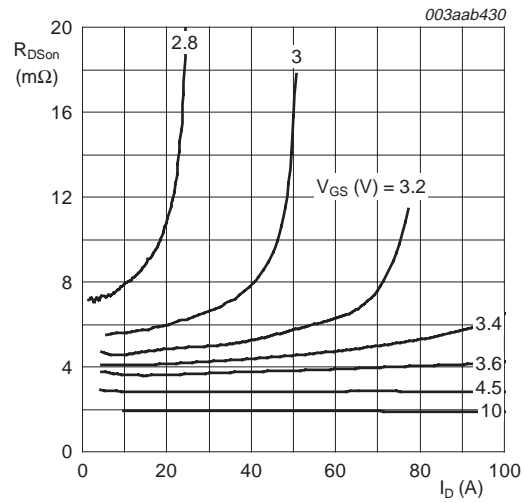

T_j = 25 °C

Fig 6. Drain-source on-state resistance as a function of drain current; typical values

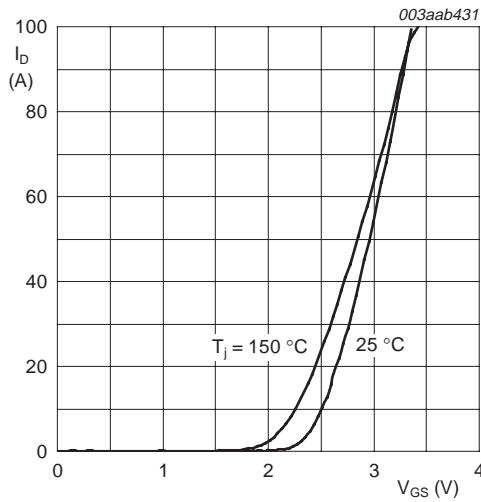

T_j = 25 °C and 150 °C; V_{DS} > I_D × R_{DSon}

Fig 7. Transfer characteristics: drain current as a function of gate-source voltage; typical values

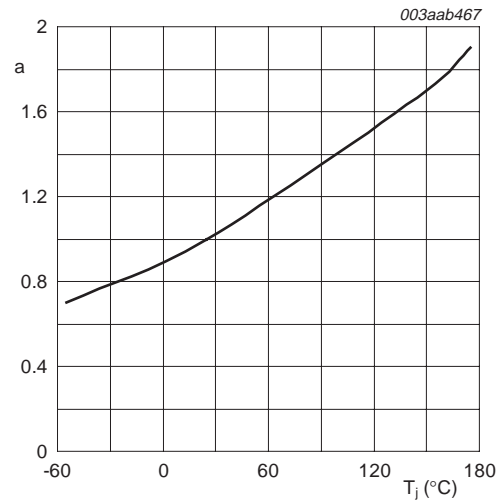

$$a = \frac{R_{DSon}}{R_{DSon(25^{\circ}C)}}$$

Fig 8. Normalized drain-source on-state resistance factor as a function of junction temperature

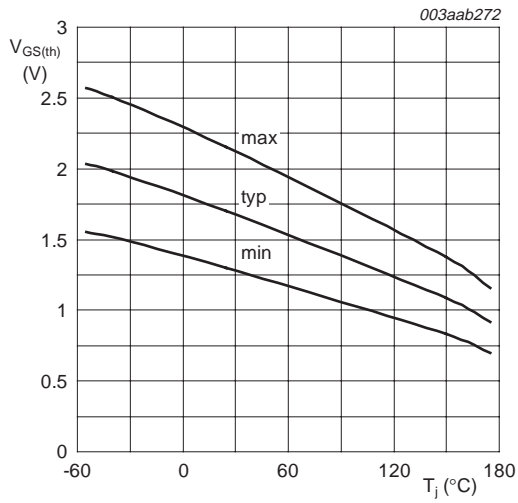

$I_D = 1 \text{ mA}; V_{DS} = V_{GS}$

Fig 9. Gate-source threshold voltage as a function of junction temperature

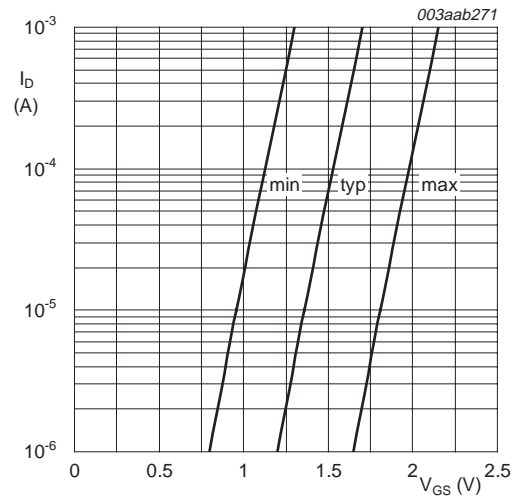

$T_j = 25 \text{ }^{\circ}C; V_{DS} = 5 \text{ V}$

Fig 10. Sub-threshold drain current as a function of gate-source voltage

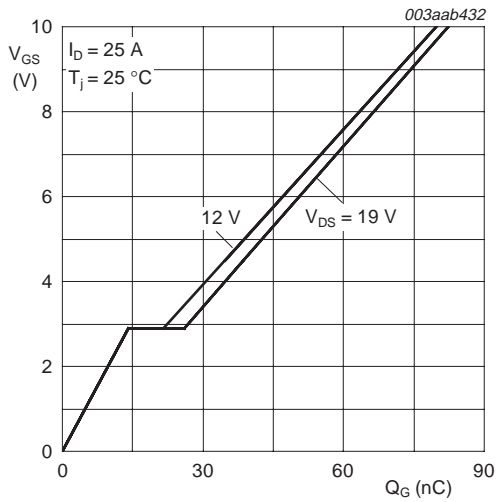

$I_D = 25 \text{ A}; V_{DS} = 12 \text{ V and } 19 \text{ V}$

Fig 11. Gate-source voltage as a function of gate charge; typical values

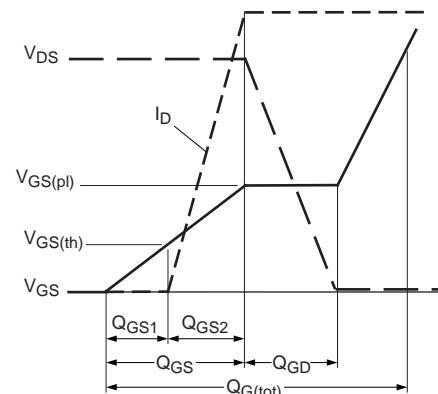
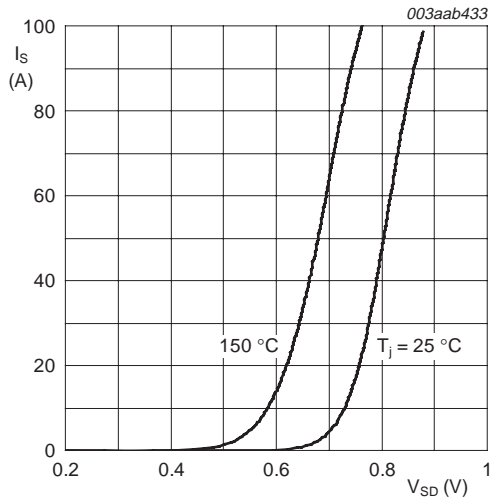
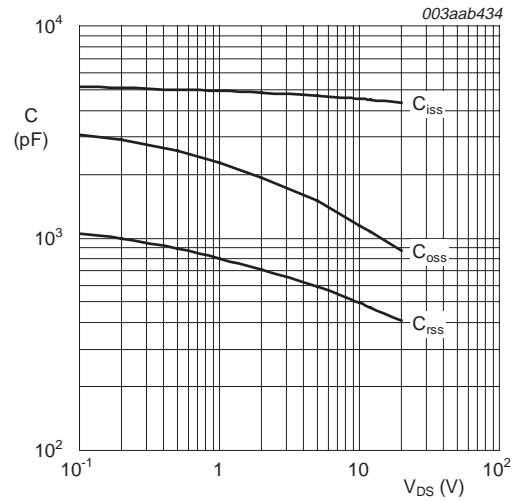

Fig 12. Gate charge waveform definitions



$T_j = 25\text{ }^\circ\text{C}$ and $150\text{ }^\circ\text{C}$; $V_{GS} = 0\text{ V}$

Fig 13. Source current as a function of source-drain voltage; typical values



$V_{GS} = 0\text{ V}$; $f = 1\text{ MHz}$

Fig 14. Input, output and reverse transfer capacitances as a function of drain-source voltage; typical values

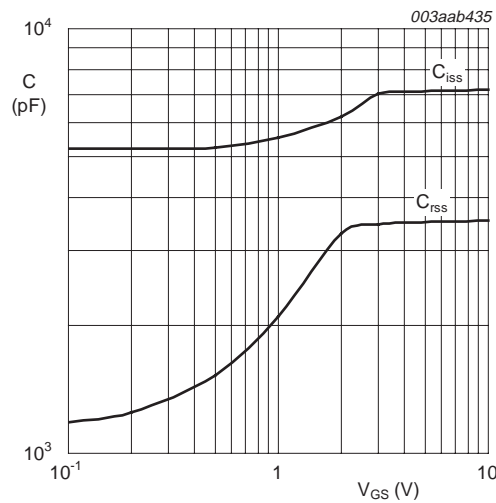

$V_{DS} = 0\text{ V}$; $f = 1\text{ MHz}$

Fig 15. Input and reverse transfer capacitances as a function of gate-source voltage; typical values

7. Package outline

Plastic single-ended surface-mounted package (LPAK); 4 leads

SOT669

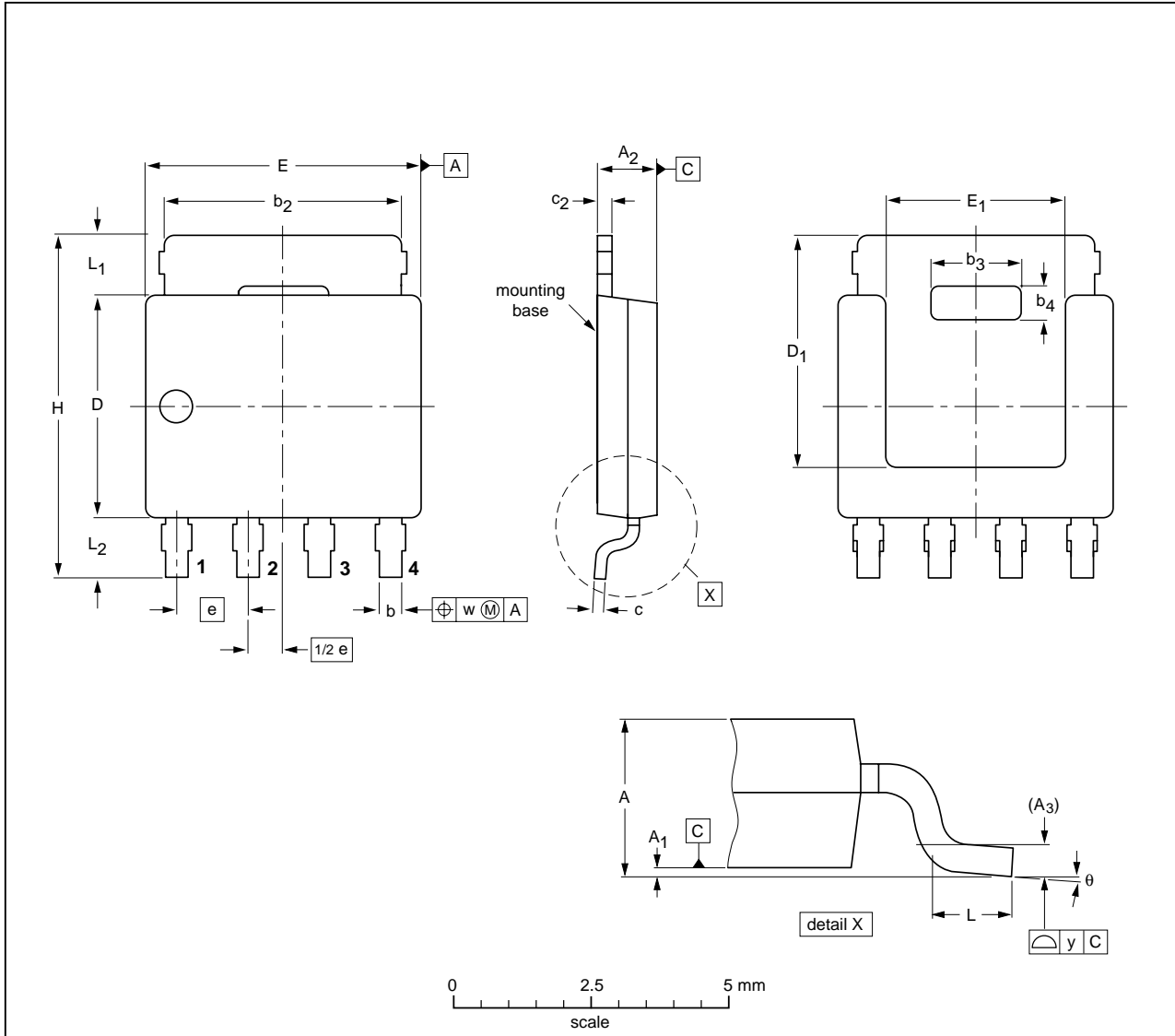

DIMENSIONS (mm are the original dimensions)

UNIT	A	A ₁	A ₂	A ₃	b	b ₂	b ₃	b ₄	c	c ₂	D ⁽¹⁾	D ₁ ⁽¹⁾ _{max}	E ⁽¹⁾	E ₁ ⁽¹⁾	e	H	L	L ₁	L ₂	w	y	θ
mm	1.20 1.01	0.15 0.00	1.10 0.95	0.25	0.50 0.35	4.41 3.62	2.2 2.0	0.9 0.7	0.25 0.19	0.30 0.24	4.10 3.80	4.20	5.0 4.8	3.3 3.1	1.27	6.2 5.8	0.85 0.40	1.3 0.8	1.3 0.8	0.25	0.1	8° 0°

Note

1. Plastic or metal protrusions of 0.15 mm maximum per side are not included.

OUTLINE VERSION	REFERENCES				EUROPEAN PROJECTION	ISSUE DATE
	IEC	JEDEC	JEITA			
SOT669		MO-235				04-10-13 06-03-16

Fig 16. Package outline SOT669 (LPAK)

8. Revision history

Table 6. Revision history

Document ID	Release date	Data sheet status	Change notice	Supersedes
PH2525L_2	20061205	Product data sheet	-	PH2525L_1
Modifications:	• Section 1.2 : updated the list			
PH2525L_1	20061010	Product data sheet	-	-

9. Legal information

9.1 Data sheet status

Document status ^{[1][2]}	Product status ^[3]	Definition
Objective [short] data sheet	Development	This document contains data from the objective specification for product development.
Preliminary [short] data sheet	Qualification	This document contains data from the preliminary specification.
Product [short] data sheet	Production	This document contains the product specification.

[1] Please consult the most recently issued document before initiating or completing a design.

[2] The term 'short data sheet' is explained in section "Definitions".

[3] The product status of device(s) described in this document may have changed since this document was published and may differ in case of multiple devices. The latest product status information is available on the Internet at URL <http://www.nxp.com>.

9.2 Definitions

Draft — The document is a draft version only. The content is still under internal review and subject to formal approval, which may result in modifications or additions. NXP Semiconductors does not give any representations or warranties as to the accuracy or completeness of information included herein and shall have no liability for the consequences of use of such information.

Short data sheet — A short data sheet is an extract from a full data sheet with the same product type number(s) and title. A short data sheet is intended for quick reference only and should not be relied upon to contain detailed and full information. For detailed and full information see the relevant full data sheet, which is available on request via the local NXP Semiconductors sales office. In case of any inconsistency or conflict with the short data sheet, the full data sheet shall prevail.

9.3 Disclaimers

General — Information in this document is believed to be accurate and reliable. However, NXP Semiconductors does not give any representations or warranties, expressed or implied, as to the accuracy or completeness of such information and shall have no liability for the consequences of use of such information.

Right to make changes — NXP Semiconductors reserves the right to make changes to information published in this document, including without limitation specifications and product descriptions, at any time and without notice. This document supersedes and replaces all information supplied prior to the publication hereof.

Suitability for use — NXP Semiconductors products are not designed, authorized or warranted to be suitable for use in medical, military, aircraft, space or life support equipment, nor in applications where failure or malfunction of a NXP Semiconductors product can reasonably be expected to

result in personal injury, death or severe property or environmental damage. NXP Semiconductors accepts no liability for inclusion and/or use of NXP Semiconductors products in such equipment or applications and therefore such inclusion and/or use is at the customer's own risk.

Applications — Applications that are described herein for any of these products are for illustrative purposes only. NXP Semiconductors makes no representation or warranty that such applications will be suitable for the specified use without further testing or modification.

Limiting values — Stress above one or more limiting values (as defined in the Absolute Maximum Ratings System of IEC 60134) may cause permanent damage to the device. Limiting values are stress ratings only and operation of the device at these or any other conditions above those given in the Characteristics sections of this document is not implied. Exposure to limiting values for extended periods may affect device reliability.

Terms and conditions of sale — NXP Semiconductors products are sold subject to the general terms and conditions of commercial sale, as published at <http://www.nxp.com/profile/terms>, including those pertaining to warranty, intellectual property rights infringement and limitation of liability, unless explicitly otherwise agreed to in writing by NXP Semiconductors. In case of any inconsistency or conflict between information in this document and such terms and conditions, the latter will prevail.

No offer to sell or license — Nothing in this document may be interpreted or construed as an offer to sell products that is open for acceptance or the grant, conveyance or implication of any license under any copyrights, patents or other industrial or intellectual property rights.

9.4 Trademarks

Notice: All referenced brands, product names, service names and trademarks are the property of their respective owners.

TrenchMOS — is a trademark of NXP B.V.

10. Contact information

For additional information, please visit: <http://www.nxp.com>

For sales office addresses, send an email to: salesaddresses@nxp.com

11. Contents

1	Product profile	1
1.1	General description	1
1.2	Features	1
1.3	Applications	1
1.4	Quick reference data	1
2	Pinning information	1
3	Ordering information	2
4	Limiting values	2
5	Thermal characteristics	4
6	Characteristics	5
7	Package outline	9
8	Revision history	10
9	Legal information	11
9.1	Data sheet status	11
9.2	Definitions	11
9.3	Disclaimers	11
9.4	Trademarks	11
10	Contact information	11
11	Contents	12

Please be aware that important notices concerning this document and the product(s) described herein, have been included in section 'Legal information'.



© NXP B.V. 2006.

All rights reserved.

For more information, please visit: <http://www.nxp.com>

For sales office addresses, please send an email to: salesaddresses@nxp.com

Date of release: 5 December 2006

Document identifier: PH2525L_2