

ADT7481

Dual Channel Temperature Sensor and Overtemperature Alarm

The ADT7481 is a 3-channel digital thermometer and under/ over temperature alarm, intended for use in PCs and thermal management systems. It can measure its own ambient temperature or the temperature of two remote thermal diodes. These thermal diodes can be located in a CPU or GPU, or they can be discrete diode connected transistors. The ambient temperature, or the temperature of the remote thermal diode, can be accurately measured to $\pm 1^{\circ}\text{C}$. The temperature measurement range defaults to 0°C to $+127^{\circ}\text{C}$, compatible with ADM1032, but can be switched to a wider measurement range from -64°C to $+191^{\circ}\text{C}$.

The ADT7481 communicates over a 2-wire serial interface compatible with System Management Bus (SMBus) standards. The SMBus address of the ADT7481 is $0x4C$. An ADT7481-1 with an SMBus address of $0x4B$ is also available.

An $\overline{\text{ALERT}}$ output signals when the on-chip or remote temperature is outside the programmed limits. The $\overline{\text{THERM}}$ output is a comparator output that allows, for example, on/off control of a cooling fan. The $\overline{\text{ALERT}}$ output can be reconfigured as a second $\overline{\text{THERM}}$ output if required.

Features

- 1 Local and 2 Remote Temperature Sensors
- 0.25°C Resolution/ 1°C Accuracy on Remote Channels
- 1°C Resolution/ 1°C Accuracy on Local Channel
- Extended, Switchable Temperature Measurement Range 0°C to 127°C (Default) or -64°C to $+191^{\circ}\text{C}$
- 2-Wire SMBus Serial Interface with SMBus $\overline{\text{ALERT}}$ Support
- Programmable Over/Undertemperature Limits
- Offset Registers for System Calibration
- Up to 2 Overtemperature Fail-Safe $\overline{\text{THERM}}$ Outputs
- Small 10-Lead MSOP Package
- $240\ \mu\text{A}$ Operating Current, $5\ \mu\text{A}$ Standby Current
- These are Pb-Free Devices

Applications

- Desktop and Notebook Computers
- Industrial Controllers
- Smart Batteries
- Automotive
- Embedded Systems
- Burn-In Applications
- Instrumentation



ON Semiconductor®

<http://onsemi.com>

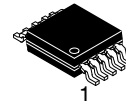

MSOP-10
CASE 846AC

MARKING DIAGRAM

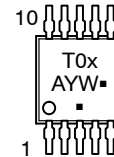

T0x = Refer to Ordering Info Table
A = Assembly Location
Y = Year
W = Work Week
▪ = Pb-Free Package
(Note: Microdot may be in either location)

PIN ASSIGNMENT

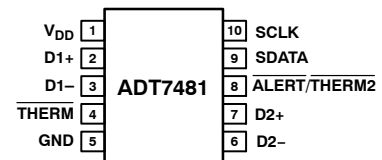

ORDERING INFORMATION

See detailed ordering and shipping information in the package dimensions section on page 19 of this data sheet.

ADT7481

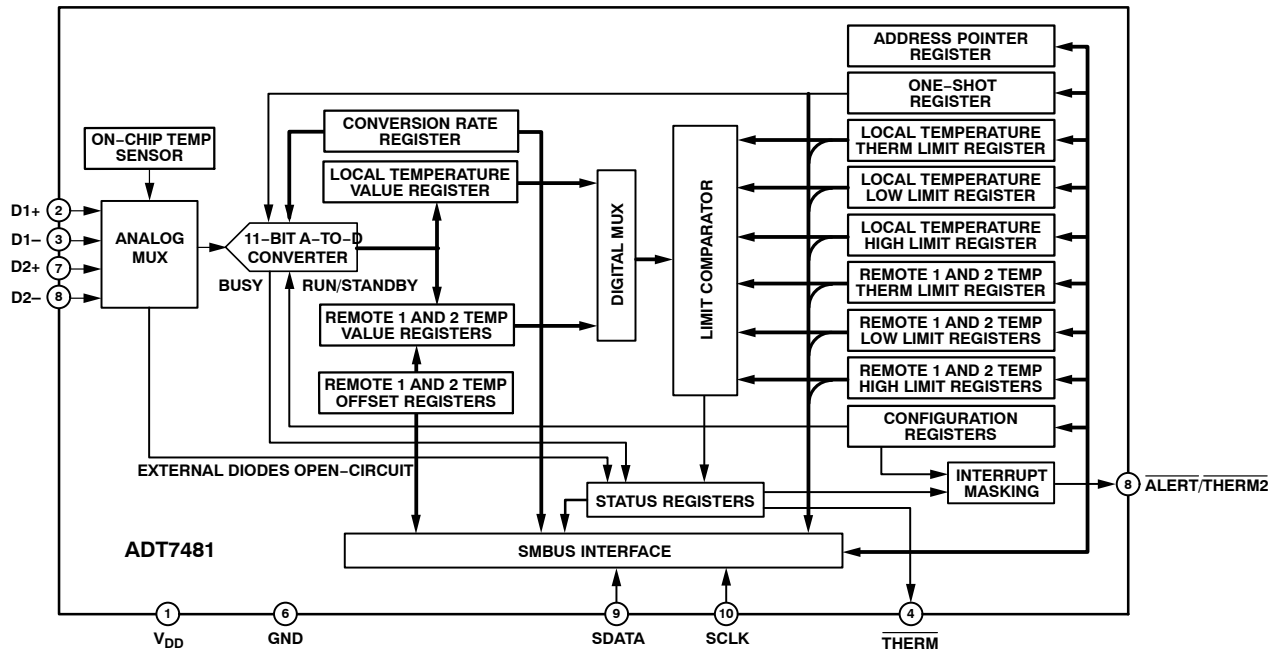

Figure 1. Functional Block Diagram

ABSOLUTE MAXIMUM RATINGS

Parameter	Rating	Unit
Positive Supply Voltage (V_{DD}) to GND	-0.3 to +3.6	V
D+	-0.3 to $V_{DD} + 0.3$	V
D- to GND	-0.3 to +0.6	V
SCLK, SDATA, ALERT, THERM	-0.3 to +3.6	V
Input Current, SDATA, THERM	-1 to +50	mA
Input Current, D-	± 1	mA
ESD Rating, All Pins (Human Body Model)	1500	V
Maximum Junction Temperature (T_J max)	150	$^{\circ}\text{C}$
Storage Temperature Range	-65 to +150	$^{\circ}\text{C}$
IR Reflow Peak Temperature	220	$^{\circ}\text{C}$
IR Reflow Peak Temperature for Pb-Free	260	$^{\circ}\text{C}$
Lead Temperature, Soldering (10 sec)	300	$^{\circ}\text{C}$

Stresses exceeding Maximum Ratings may damage the device. Maximum Ratings are stress ratings only. Functional operation above the Recommended Operating Conditions is not implied. Extended exposure to stresses above the Recommended Operating Conditions may affect device reliability.

NOTE: This device is ESD sensitive. Use standard ESD precautions when handling.

THERMAL CHARACTERISTICS

Package Type	θ_{JA}	θ_{JC}	Unit
10-Lead MSOP	142	43.74	$^{\circ}\text{C}/\text{W}$

ADT7481

PIN ASSIGNMENT

Pin No.	Mnemonic	Description
1	V _{DD}	Positive Supply, 3.0 V to 3.6 V.
2	D1+	Positive Connection to the Remote 1 Temperature Sensor.
3	D1-	Negative Connection to the Remote 1 Temperature Sensor.
4	$\overline{\text{THERM}}$	Open-Drain Output. Requires pullup resistor. Signals overtemperature events, could be used to turn a fan on/off, or throttle a CPU clock.
5	GND	Supply Ground Connection.
6	D2-	Negative Connection to the Remote 2 Temperature Sensor.
7	D2+	Positive Connection to the Remote 2 Temperature Sensor.
8	ALERT/THERM2	Open-Drain Logic Output. Used as interrupt or SMBALERT. This may also be configured as a second THERM output. Requires pullup resistor.
9	SDATA	Logic Input/Output, SMBus Serial Data. Open-Drain Output. Requires pullup resistor.
10	SCLK	Logic Input, SMBus Serial Clock. Requires pullup resistor.

TIMING SPECIFICATIONS (Note 1)

Parameter	Limit at T _{MIN} and T _{MAX}	Unit	Description
f _{SCLK}	400	kHz max	
t _{LOW}	4.7	μs min	Clock low period, between 10% points
t _{HIGH}	4.0	μs min	Clock high period, between 90% points
t _R	1.0	μs max	Clock/data rise time
t _F	300	ns max	Clock/data fall time
t _{SU; STA}	4.7	μs min	Start condition setup time
t _{HD; STA} (Note 2)	4.0	μs min	Start condition hold time
t _{SU; DAT} (Note 3)	250	ns min	Data setup time
t _{SU; STO} (Note 4)	4.0	μs min	Stop condition setup time
t _{BUF}	4.7	μs min	Bus free time between stop and start conditions

1. Guaranteed by design, not production tested.
2. Time from 10% of SDATA to 90% of SCLK.
3. Time for 10% or 90% of SDATA to 10% of SCLK.
4. Time for 90% of SCLK to 10% of SDATA.

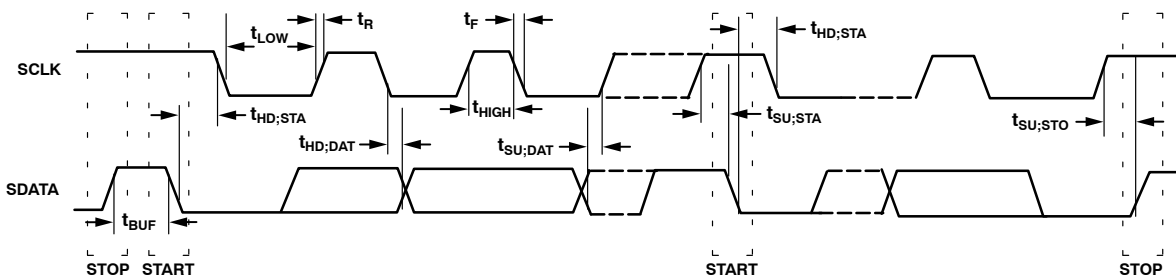

Figure 2. Serial Bus Timing

ADT7481

ELECTRICAL CHARACTERISTICS (T_A = -40°C to +120°C, V_{DD} = 3.0 V to 3.6 V, unless otherwise noted)

Parameter	Conditions	Min	Typ	Max	Unit
Power Supply					
Supply Voltage, V _{DD}		3.0	3.30	3.6	V
Average Operating Supply Current, I _{DD}	0.0625 Conversions/Sec Rate (Note 1)		3.0	4.0	mA
	Standby mode		5.0	30	μA
Undervoltage Lockout Threshold	V _{DD} input, disables ADC, rising edge		2.55		V
Power-On-Reset Threshold		1.0		2.5	V

Temperature-To-Digital Converter

Local Sensor Accuracy (Note 2)	0°C ≤ T _A ≤ +70°C 0°C ≤ T _A ≤ +85°C -40 ≤ T _A ≤ +100°C			±1 ±1.5 ±2.5	°C
Resolution			1.0		°C
Remote Diode Sensor Accuracy (Note 2)	0°C ≤ T _A ≤ +70°C, -55°C ≤ T _D (Note 3) ≤ +150°C 0°C ≤ T _A ≤ +85°C, -55°C ≤ T _D (Note 3) ≤ +150°C -40°C ≤ T _A ≤ +100°C, -55°C ≤ T _D (Note 3) ≤ +150°C			±1 ±1.5 ±2.5	°C
Resolution			0.25		°C
Remote Sensor Source Current	High level (Note 4)		233		μA
	Low level (Note 4)		14		μA
Conversion Time	From stop bit to conversion complete (both channels) one-shot mode with averaging switched on		73	94	ms
	One-shot mode with averaging off (conversion rate = 16, 32, or 64 conversions per second)		11	14	ms

Open-Drain Digital Outputs (THERM, ALERT/THERM2)

Output Low Voltage, V _{OL}	I _{OUT} = -6.0 mA			0.4	V
High Level Output Leakage Current, I _{OH}	V _{OUT} = V _{DD}		0.1	1.0	μA

SMBus Interface (Notes 4 and 5)

Logic Input High Voltage, V _{IH} SCLK, SDATA		2.1			V
Logic Input Low Voltage, V _{IL} SCLK, SDATA				0.8	V
Hysteresis			500		mV
SDA Output Low Voltage, V _{OL}	I _{OUT} = -6.0 mA			0.4	V
Logic Input Current, I _{IH} , I _{IL}		-1.0		+1.0	μA
SMBus Input Capacitance, SCLK, SDATA			5.0		pF
SMBus Clock Frequency				400	kHz
SMBus Timeout (Note 6)	User programmable		25	32	ms
SCLK Falling Edge to SDATA Valid Time	Master clocking in data			1.0	μs

1. See Table 6 for information on other conversion rates.
2. Averaging enabled.
3. Guaranteed by characterization, not production tested.
4. Guaranteed by design, not production tested.
5. See Timing Specifications section for more information.
6. Disabled by default. See the Serial Bus Interface section for details to enable it.

TYPICAL CHARACTERISTICS

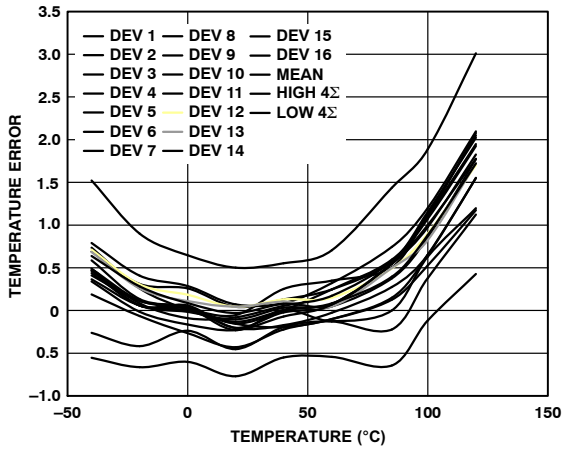

Figure 3. Local Temperature Error vs. Temperature

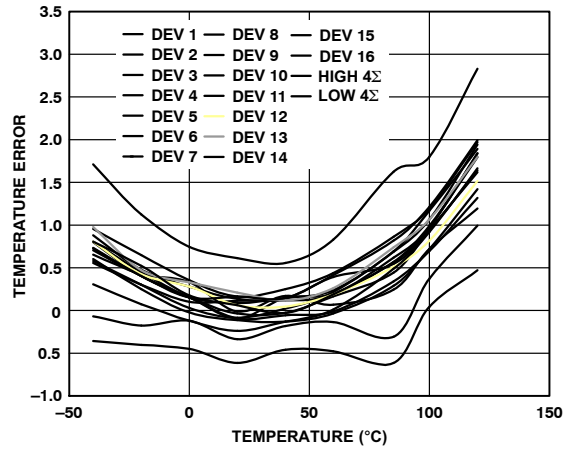

Figure 4. Remote 1 Temperature Error vs. Temperature

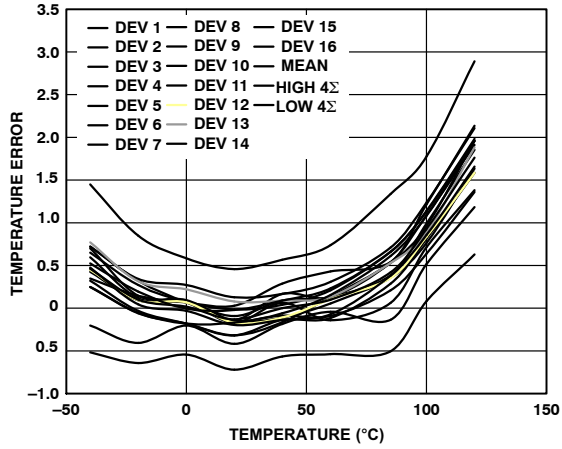

Figure 5. Remote 2 Temperature Error vs. Temperature

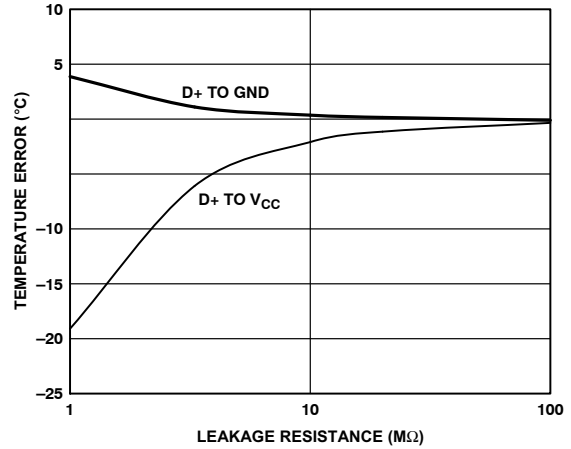

Figure 6. Temperature Error vs. D+/D- Leakage Resistance

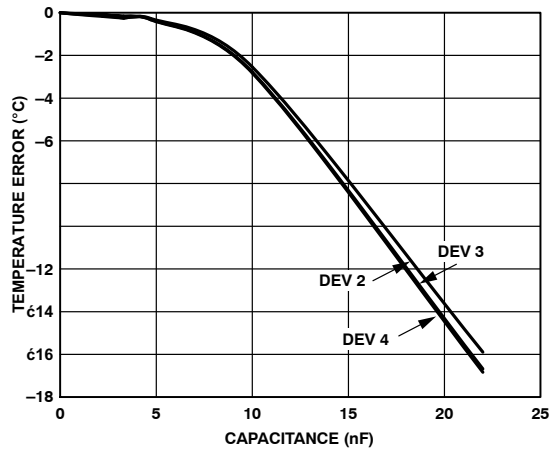

Figure 7. Temperature Error vs. D+/D- Capacitance

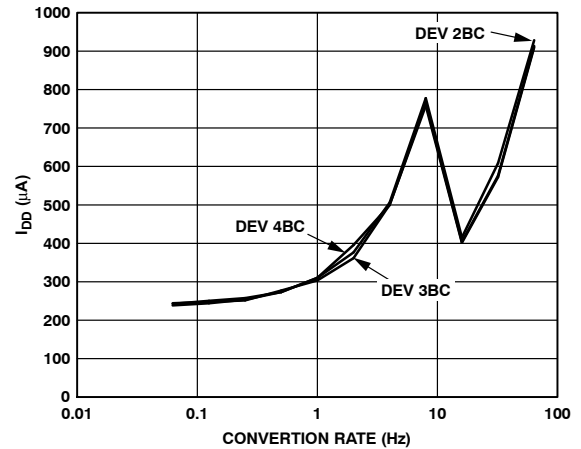

Figure 8. Operating Supply Current vs. Conversion Rate

TYPICAL CHARACTERISTICS

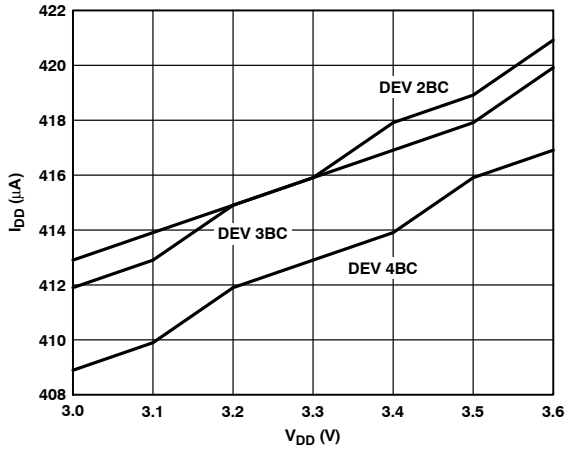

Figure 9. Operating Supply Current vs. Voltage

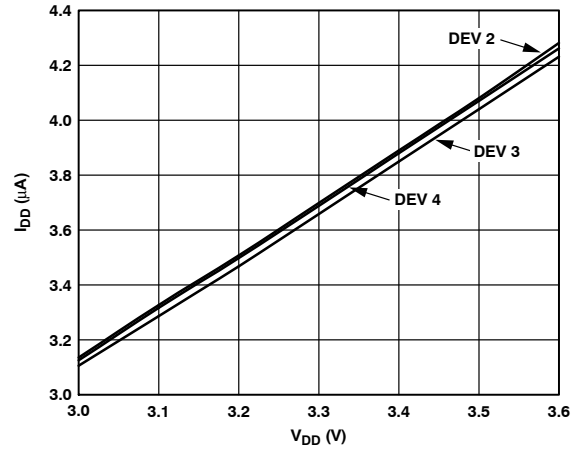

Figure 10. Standby Supply Current vs. Voltage

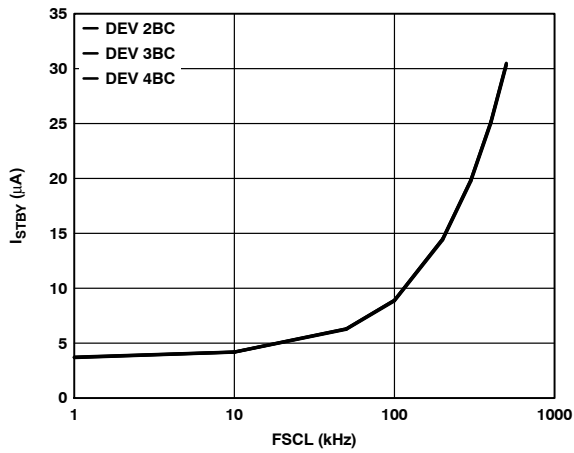

Figure 11. Standby Supply Current vs. SCLK Frequency

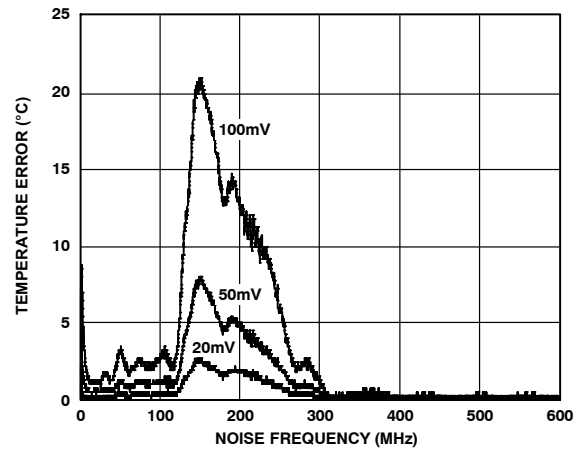

Figure 12. Temperature Error vs. Common-Mode Noise Frequency

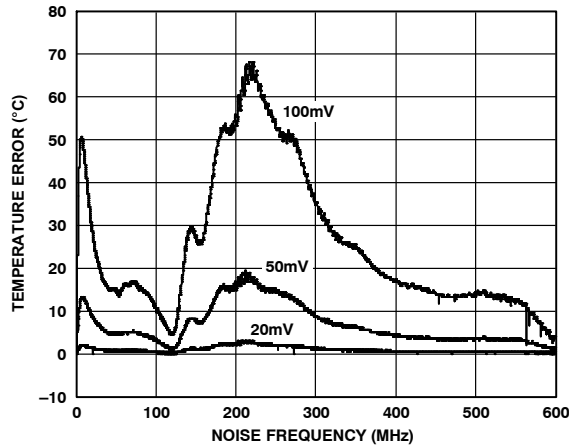

Figure 13. Temperature Error vs. Differential Mode Noise Frequency

Theory of Operation

The ADT7481 is a local and dual remote temperature sensor and over/under temperature alarm. When the ADT7481 is operating normally, the on-board ADC operates in a free-running mode. The analog input multiplexer alternately selects either the on-chip temperature sensor to measure its local temperature, or either of the remote temperature sensors. The ADC digitizes these signals and the results are stored in the local, Remote 1, and Remote 2 temperature value registers.

The local and remote measurement results are compared with the corresponding high, low, and $\overline{\text{THERM}}$ temperature limits, stored in on-chip registers. Out-of-limit comparisons generate flags that are stored in the status register. A result that exceeds the high temperature limit, the low temperature limit, or remote diode open circuit will cause the $\overline{\text{ALERT}}$ output to assert low. Exceeding $\overline{\text{THERM}}$ temperature limits causes the $\overline{\text{THERM}}$ output to assert low. The $\overline{\text{ALERT}}$ output can be reprogrammed as a second $\overline{\text{THERM}}$ output.

The limit registers can be programmed, and the device controlled and configured via the serial SMBus. The contents of any register can also be read back via the SMBus.

Control and configuration functions consist of switching the device between normal operation and standby mode, selecting the temperature measurement scale, masking or enabling the $\overline{\text{ALERT}}$ output, switching Pin 8 between $\overline{\text{ALERT}}$ and $\overline{\text{THERM2}}$, and selecting the conversion rate.

Temperature Measurement Method

A simple method of measuring temperature is to exploit the negative temperature coefficient of a diode, measuring the base-emitter voltage (V_{BE}) of a transistor operated at constant current.

This technique requires calibration to null the effect of the absolute value of V_{BE} , which varies from device to device.

The technique used in the ADT7481 measures the change in V_{BE} when the device is operated at two different currents.

Figure 14 shows the input signal conditioning used to measure the output of a remote temperature sensor. This figure shows the remote sensor as a substrate transistor, but it could equally be a discrete transistor. If a discrete transistor is used, the collector is not grounded and is linked to the base. To prevent ground noise interfering with the measurement, the more negative terminal of the sensor is not referenced to ground, but is biased above ground by an internal diode at the D- input. C1 may optionally be added as a noise filter with a recommended maximum value of 1,000 pF.

To measure ΔV_{BE} , the operating current through the sensor is switched among two related currents. The currents through the temperature diode are switched between I, and $N \times I$, giving ΔV_{BE} . The temperature can then be calculated using the ΔV_{BE} measurement.

The resulting ΔV_{BE} waveforms pass through a 65 kHz low-pass filter to remove noise and then to a chopper-stabilized amplifier. This amplifies and rectifies the waveform to produce a dc voltage proportional to ΔV_{BE} . The ADC digitizes this voltage producing a temperature measurement. To reduce the effects of noise, digital filtering is performed by averaging the results of 16 measurement cycles for low conversion rates. At rates of 16, 32, and 64 conversions/second, no digital averaging takes place.

Signal conditioning and measurement of the local temperature sensor is performed in the same manner.

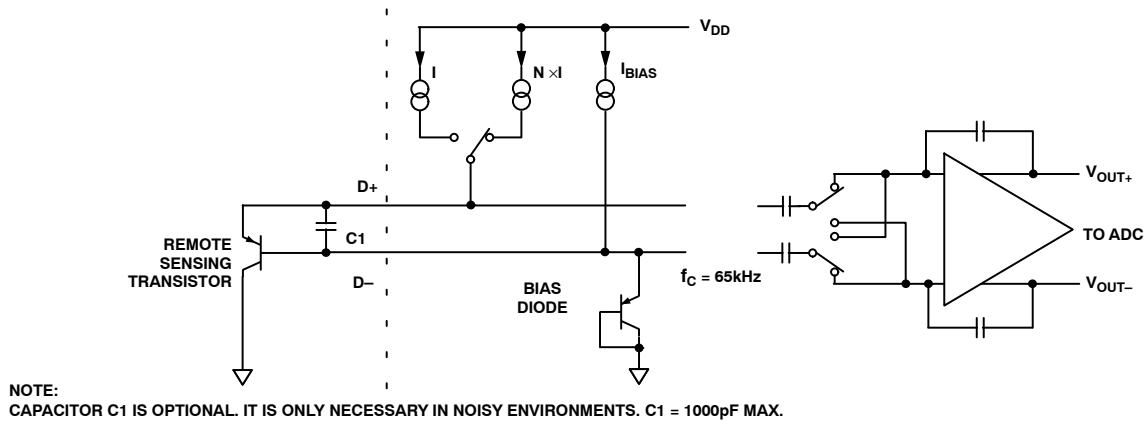

Figure 14. Input Signal Conditioning

Temperature Measurement Results

The results of the local and remote temperature measurements are stored in the local and remote temperature value registers and are compared with limits programmed into the local and remote high and low limit registers.

The local temperature measurement is an 8-bit measurement with 1°C resolution. The remote temperature measurements are 10-bit measurements, with the 8 MSBs stored in one register and the 2 LSBs stored in another register. Table 1 is a list of the temperature measurement registers.

Table 1. Register Address for the Temperature Values

Temperature Channel	Register Address, MSBs	Register Address, LSBs
Local	0x00	N/A
Remote 1	0x01	0x10 (2 MSBs)
Remote 2	0x30	0x33 (2 MSBs)

If Bit 3 of the Configuration 1 register is set to 1, then the Remote 2 temperature values can be read from the following register addresses:

Remote 2, MSBs = 0x01

Remote 2, LSBs = 0x10

The above is true only when Bit 3 of the Configuration 1 register is set. To read the Remote 1 temperatures, this bit needs to be switched back to 0.

Only the two MSBs in the remote temperature low byte are used. This gives the remote temperature measurement a resolution of 0.25°C. Table 2 shows the data format for the remote temperature low byte.

Table 2. Extended Temperature Resolution (Remote Temperature Low Byte)

Extended Resolution	Remote Temperature Low Byte
0.00°C	0 000 0000
0.25°C	0 100 0000
0.50°C	1 000 0000
0.75°C	1 100 0000

When reading the full remote temperature value, including both the high and low byte, the two registers should be read LSB first and then the MSB. This is because reading the LSB will cause the MSB to be locked until it is read. This is to guarantee that the two values read are derived from the same temperature measurement. The MSB register updates only after it has been read. The MSB will not lock if a SMBus repeat start is used between reading the two registers. There needs to be a stop between reading the LSB and MSB.

If the LSB register is read but not the MSB register, then fail-safe protection is provided by the THERM and ALERT signals which update with the latest temperature measurements rather than the register values.

Temperature Measurement Range

The temperature measurement range for both local and remote measurements is, by default, 0°C to +127°C. However, the ADT7481 can be operated using an extended temperature range. The temperature range in the extended mode is -64°C to +191°C. The user can switch between these two temperature ranges by setting or clearing Bit 2 in the Configuration 1 register. A valid result is available in the next measurement cycle after changing the temperature range.

Bit 2 Configuration Register 2 = 0 = 0°C to +127°C = default

Bit 2 Configuration Register 2 = 1 = -64°C to +191°C

In extended temperature mode, the upper and lower temperatures that can be measured by the ADT7481 are limited by the remote diode selection. While the temperature registers can have values from -64°C to +191°C, most temperature sensing diodes have a maximum temperature range of -55°C to +150°C.

Note that while both local and remote temperature measurements can be made while the part is in extended temperature mode, the ADT7481 should not be exposed to temperatures greater than those specified in the Absolute section. Furthermore, the device is only guaranteed to operate as specified at ambient temperatures from -40°C to +120°C.

Temperature Data Format

The ADT7481 has two temperature data formats. When the temperature measurement range is from 0°C to +127°C (default), the temperature data format is binary for both local and remote temperature results. See the Temperature Measurement Range section for information on how to switch between the two data formats.

When the measurement range is in extended mode, an offset binary data format is used for both local and remote results. Temperature values in the offset binary data format are offset by +64. Examples of temperatures in both data formats are shown in Table 3.

Table 3. Temperature Data Format (Local and Remote Temperature High Byte)

Temperature	Binary	Offset Binary (Note 1)
-55°C	0 000 0000 (Note 2)	0 000 1001
110°C	0 000 0000	0 100 0000
+1°C	0 000 0001	0 100 0001
+10°C	0 000 1010	0 100 1010
+25°C	0 001 1001	0 101 1001
+50°C	0 011 0010	0 111 0010
+75°C	0 100 1011	1 000 1011
+100°C	0 110 0100	1 010 0100
+125°C	0 111 1101	1 011 1101
+127°C	0 111 1111	1 011 1111
+150°C	0 111 1111 (Note 3)	1 101 0110

1. Offset binary scale temperature values are offset by +64.
2. Binary scale temperature measurement returns 0 for all temperatures <0°C.
3. Binary scale temperature measurement returns 127 for all temperatures >127°C.

The user may switch between measurement ranges at any time. Switching the range will also switch the data format. The next temperature result following the switching will be reported back to the register in the new format. However, the contents of the limit registers will not change. It is up to the user to ensure that when the data format changes, the limit registers are reprogrammed as necessary. More information on this can be found in the Limit Registers section.

ADT7481

Registers

The registers in the ADT7481 are eight bits wide. These registers are used to store the results of remote and local temperature measurements, high and low temperature limits, and to configure and control the device. A description of these registers follows.

Address Pointer Register

The address pointer register does not have, nor does it require, an address because the first byte of every write operation is automatically written to this register. The data in this first byte always contains the address of another register on the ADT7481, which is stored in the address pointer register. It is to this register address that the second byte of a write operation is written to, or to which a subsequent read operation is performed.

The power-on default value of the address pointer register is 0x00, so if a read operation is performed immediately after power-on, without first writing to the address pointer, the value of the local temperature will be returned since its register address is 0x00.

Temperature Value Registers

The ADT7481 has five registers to store the results of local and remote temperature measurements. These registers can only be written to by the ADC and read by the user over the SMBus.

- The local temperature value register is at Address 0x00.
- The Remote 1 temperature value high byte register is at Address 0x01, with the Remote 1 low byte register at Address 0x10.
- The Remote 2 temperature value high byte register is at Address 0x30, with the Remote 2 low byte register at Address 0x33.
- The Remote 2 temperature values can also be read from Address 0x01 for the high byte, and Address 0x10 for the low byte if Bit 3 of Configuration Register 1 is set to 1.
- To read the Remote 1 temperature values, set Bit 3 of Configuration Register 1 to 0.
- The power-on default value for all five registers is 0x00.

Table 4. Configuration 1 Register (Read Address 0x03, Write Address 0x09)

Bit	Mnemonic	Function
7	Mask	Setting this bit to 1 masks all $\overline{\text{ALERT}}$ s on the $\overline{\text{ALERT}}$ pin. Default = 0 = $\overline{\text{ALERT}}$ enabled. This applies only if Pin 8 is configured as $\overline{\text{ALERT}}$, otherwise it has no effect.
6	Mon/STBY	Setting this bit to 1 places the ADT7481 in standby mode, that is, it suspends all temperature measurements (ADC). The SMBus remains active and values can be written to, and read from, the registers. However $\overline{\text{THERM}}$ and $\overline{\text{ALERT}}$ are not active in standby mode, and their states in standby mode are not reliable. Default = 0 = temperature monitoring enabled.
5	AL/TH	This bit selects the function of Pin 8. Default = 0 = $\overline{\text{ALERT}}$. Setting this bit to 1 configures Pin 8 as the $\overline{\text{THERM2}}$ pin.
4	Reserved	Reserved for future use.
3	Remote 1/2	Setting this bit to 1 enables the user to read the Remote 2 values from the Remote 1 registers. When default = 0, Remote 1 temperature values and limits are read from these registers.
2	Temp Range	Setting this bit to 1 enables the extended temperature measurement range of -64°C to $+191^{\circ}\text{C}$. When using the default = 0, the temperature range is 0°C to $+127^{\circ}\text{C}$.
1	Mask R1	Setting this bit to 1 masks $\overline{\text{ALERT}}$ s due to the Remote 1 temperature exceeding a programmed limit. Default = 0.
0	Mask R2	Setting this bit to 1 masks $\overline{\text{ALERT}}$ s due to the Remote 2 temperature exceeding a programmed limit. Default = 0.

Table 5. Configuration 2 Register (Address 0x24)

Bit	Mnemonic	Function
7	Lock Bit	Setting this bit to 1 locks all lockable registers to their current values. This prevents tampering with settings until the device is powered down. Default = 0.
<6:0>	Res	Reserved for future use.

Conversion Rate/Channel Selector Register

The conversion rate/channel selector register for reads is at Address 0x04, and at Address 0x0A for writes. The four LSBs of this register are used to program the conversion times from 15.5 ms (Code 0x0A) to 16 seconds (Code 0x00). To program the ADT7481 to perform continuous measurements, set the conversion rate register to 0x0B. For example, a conversion rate of eight conversions/second means that beginning at 125 ms intervals, the device performs a conversion on the local and the remote temperature channels.

This register can be written to, and read back from, the SMBus. The default value of this register is 0x08, giving a rate of 16 conversions per second. Using slower conversion times greatly reduces the device power consumption.

Bit 7 in this register can be used to disable averaging of the temperature measurements. All temperature channels are measured by default. It is possible to configure the ADT7481 to measure the temperature of one channel only. This can be configured using Bit 4 and Bit 5 (see Table 6).

Table 6. Conversion Rate/Channel Selector Register (Read Address 0x04, Write Address 0x0A)

Bit	Mnemonic	Function																										
7	Averaging	Setting this bit to 1 disables averaging of the temperature measurements at the slower conversion rates (averaging cannot take place at the three faster rates, so setting this bit has no effect). When default = 0, averaging is enabled.																										
6	Reserved	Reserved for future use. Do not write to this bit.																										
<5:4>	Channel Selector	These bits are used to select the temperature measurement channels: 00 = Round robin = default = all channels measured 01 = Local temperature only measured 10 = Remote 1 temperature only measured 11 = Remote 2 temperature only measured																										
<3:0>	Conversion Rates	These bits set how often the ADT7481 measures each temperature channel. Conversion rates are as follows:																										
		<table border="1"> <thead> <tr> <th>Conversions/sec</th> <th>Time (seconds)</th> </tr> </thead> <tbody> <tr><td>0000 = 0.0625</td><td>16</td></tr> <tr><td>0001 = 0.125</td><td>8</td></tr> <tr><td>0010 = 0.25</td><td>4</td></tr> <tr><td>0011 = 0.5</td><td>2</td></tr> <tr><td>0100 = 1</td><td>1</td></tr> <tr><td>0101 = 2</td><td>500 m</td></tr> <tr><td>0110 = 4</td><td>250 m</td></tr> <tr><td>0111 = 8 = default</td><td>125 m</td></tr> <tr><td>1000 = 16</td><td>62.5 m</td></tr> <tr><td>1001 = 32</td><td>31.25 m</td></tr> <tr><td>1010 = 64</td><td>15.5 m</td></tr> <tr><td>1011 = continuous measurements</td><td>73 m (averaging enabled)</td></tr> </tbody> </table>	Conversions/sec	Time (seconds)	0000 = 0.0625	16	0001 = 0.125	8	0010 = 0.25	4	0011 = 0.5	2	0100 = 1	1	0101 = 2	500 m	0110 = 4	250 m	0111 = 8 = default	125 m	1000 = 16	62.5 m	1001 = 32	31.25 m	1010 = 64	15.5 m	1011 = continuous measurements	73 m (averaging enabled)
Conversions/sec	Time (seconds)																											
0000 = 0.0625	16																											
0001 = 0.125	8																											
0010 = 0.25	4																											
0011 = 0.5	2																											
0100 = 1	1																											
0101 = 2	500 m																											
0110 = 4	250 m																											
0111 = 8 = default	125 m																											
1000 = 16	62.5 m																											
1001 = 32	31.25 m																											
1010 = 64	15.5 m																											
1011 = continuous measurements	73 m (averaging enabled)																											

Limit Registers

The ADT7481 has three limits for each temperature channel: high, low, and $\overline{\text{THERM}}$ temperature limits for local, Remote 1, and Remote 2 temperature measurements. The remote temperature high and low limits span two registers each to contain an upper and lower byte for each limit. There is also a $\overline{\text{THERM}}$ hysteresis register. All limit registers can be written to, and read back from, the SMBus. See Table 11 for details of the limit register addresses and power-on default values.

C will result in an out-of-limit condition, setting a flag in the status register.

If the low limit register is programmed with 0°C, measuring 0°C or lower will result in an out-of-limit condition.

Exceeding either the local or remote $\overline{\text{THERM}}$ limit asserts $\overline{\text{THERM}}$ low. When Pin 8 is configured as $\overline{\text{THERM2}}$, exceeding either the local or remote high limit asserts $\overline{\text{THERM2}}$ low. A default hysteresis value of 10°C is provided that applies to both $\overline{\text{THERM}}$ channels. This hysteresis value may be reprogrammed.

It is important to remember that the temperature limits data format is the same as the temperature measurement data format. So if the temperature measurement uses the default binary scale, then the temperature limits also use the binary scale. If the temperature measurement scale is switched, however, the temperature limits do not automatically switch.

The user must reprogram the limit registers to the desired value in the correct data format. For example, if the remote low limit is set at 10°C and the default binary scale is being

used, the limit register value should be 0000 1010b. If the scale is switched to offset binary, the value in the low temperature limit register should be reprogrammed to be 0100 1010b.

Status Registers

The status registers are read-only registers, at Address 0x02 (Status Register 1) and Address 0x23 (Status Register 2). They contain status information for the ADT7481.

Table 7. Status Register 1 Bit Assignments

Bit	Mnemonic	Function	ALERT
7	BUSY	1 when ADC converting	No
6	LHIGH (Note 1)	1 when local high temperature limit tripped	Yes
5	LLOW (Note 1)	1 when local low temperature limit tripped	Yes
4	R1HIGH ¹	1 When Remote 1 High Temperature Limit Tripped	Yes
3	R1LOW (Note 1)	1 When Remote 1 Low Temperature Limit Tripped	Yes
2	D1 OPEN (Note 1)	1 When Remote 1 Sensor Open Circuit	Yes
1	R1THR $\overline{\text{M}}$ 1	1 when Remote1 $\overline{\text{THERM}}$ Limit Tripped	No
0	LTHR $\overline{\text{M}}$ 1	1 when local $\overline{\text{THERM}}$ Limit Tripped	No

1. These flags stay high until the status register is read, or they are reset by POR.

Table 8. Status Register 2 Bit Assignments

Bit	Mnemonic	Function	ALERT
7	Res	Reserved for Future Use	No
6	Res	Reserved for Future Use	No
5	Res	Reserved for Future Use	No
4	R2HIGH (Note 1)	1 When Remote 2 High Temperature Limit Tripped	Yes
3	R2LOW (Note 1)	1 When Remote 2 Low Temperature Limit Tripped	Yes
2	D2 OPEN (Note 1)	1 When Remote 2 Sensor Open Circuit	Yes
1	R2THRM1	1 When Remote 2 THERM Limit Tripped	No
0	ALERT	1 When ALERT Condition Exists	No

1. These flags stay high until the status register is read, or they are reset by POR.

The eight flags that can generate an $\overline{\text{ALERT}}$ are NOR'd together. When any flag is high, the $\overline{\text{ALERT}}$ interrupt latch is set and the $\overline{\text{ALERT}}$ output goes low (provided that the flag(s) is/are not masked out).

Reading the Status 1 register will clear the five flags (Bit 6 through Bit 2) in Status Register 1, provided the error conditions that caused the flags to be set have gone away. Reading the Status 2 register will clear the three flags (Bit 4 through Bit 2) in Status Register 2, provided the error conditions that caused the flags to be set have gone away. A flag bit can only be reset if the corresponding value register contains an in-limit measurement, or if the sensor is good.

The $\overline{\text{ALERT}}$ interrupt latch is not reset by reading the status register. It will be reset when the $\overline{\text{ALERT}}$ output has been serviced by the master reading the device address, provided the error condition has gone away and the status register flag bits have been reset.

When Flag 1 and/or Flag 0 of Status Register 1, or Flag 1 of Status Register 2 are set, the $\overline{\text{THERM}}$ output goes low to indicate that the temperature measurements are outside the programmed limits. The $\overline{\text{THERM}}$ output does not need to be reset, unlike the $\overline{\text{ALERT}}$ output. Once the measurements are within the limits, the corresponding status register bits are reset automatically, and the $\overline{\text{THERM}}$ output goes high. The user may add hysteresis by programming Register 0x21. The $\overline{\text{THERM}}$ output will be reset only when the temperature falls below the $\overline{\text{THERM}}$ limit minus hysteresis.

When Pin 8 is configured as $\overline{\text{THERM2}}$, only the high temperature limits are relevant. If Flag 6 and Flag 4 of Status Register 1, or Flag 4 of Status Register 2 are set, the $\overline{\text{THERM2}}$ output goes low to indicate that the temperature measurements are outside the programmed limits. Flag 5 and Flag 3 of Status Register 1, and Flag 3 of Status Register 2 have no effect on $\overline{\text{THERM2}}$. The behavior of $\overline{\text{THERM2}}$ is otherwise the same as $\overline{\text{THERM}}$.

Bit 0 of Status Register 2 gets set whenever the $\overline{\text{ALERT}}$ output is asserted low. Thus, the user need only read Status Register 2 to determine if the ADT7481 is responsible for

the $\overline{\text{ALERT}}$. This bit gets reset when the $\overline{\text{ALERT}}$ output gets reset. If the $\overline{\text{ALERT}}$ output is masked, then this bit is not set.

Offset Register

Offset errors may be introduced into the remote temperature measurement by clock noise or by the thermal diode being located away from the hot spot. To achieve the specified accuracy on this channel, these offsets must be removed.

The offset values are stored as 10-bit, twos complement values.

- The Remote 1 offset MSBs are stored in Register 0x11 and the LSBs are stored in Register 0x12 (low byte, left justified).
- The Remote 2 offset MSBs are stored in Register 0x34 and the LSBs are stored in Register 0x35 (low byte, left justified). The Remote 2 offset can be written to, or read from, the Remote 1 offset registers if Bit 3 of the Configuration 1 register is set to 1. This bit should be set to 0 (default) to read the Remote 1 offset values.

Only the upper two bits of the LSB registers are used. The MSB of the MSB offset register is the sign bit. The minimum offset that can be programmed is -128°C , and the maximum is $+127.75^{\circ}\text{C}$. The value in the offset register is added to, or subtracted from, the measured value of the remote temperature.

The offset register powers up with a default value of 0°C and will have no effect unless the user writes a different value to it.

Table 9. Sample Offset Register Codes

Offset Value	0x11/0x34	0x12/0x35
-128°C	1000 0000	00 00 0000
-4°C	1111 1100	00 00 0000
-1°C	1111 1111	00 000000
-0.25°C	1111 1111	10 00 0000
0°C	0000 0000	00 00 0000
$+0.25^{\circ}\text{C}$	0000 0000	01 00 0000
$+1^{\circ}\text{C}$	0000 0001	00 00 0000
$+4^{\circ}\text{C}$	0000 0100	00 00 0000
$+127.75^{\circ}\text{C}$	0111 1111	11 00 0000

One-Shot Register

The one-shot register is used to initiate a conversion and comparison cycle when the ADT7481 is in standby mode, after which the device returns to standby. Writing to the one-shot register address (0x0F) causes the ADT7481 to perform a conversion and comparison on both the local and the remote temperature channels. This is not a data register as such, and it is the write operation to Address 0x0F that causes the one-shot conversion. The data written to this address is irrelevant and is not stored. However the $\overline{\text{ALERT}}$ and $\overline{\text{THERM}}$ outputs are not operational in one-shot mode and should not be used.

Consecutive ALERT Register

The value written to this register determines how many out-of-limit measurements must occur before an **ALERT** is generated. The default value is that one out-of-limit measurement generates an **ALERT**. The maximum value that can be chosen is 4.

The purpose of this register is to allow the user to perform some filtering of the output. This is particularly useful at the fastest three conversion rates, where no averaging takes place. This register is at Address 0x22. This register has other functions that are listed in Table 10.

Table 10. Consecutive ALERT Register Bit

Bit	Name	Description
7	SCL Timeout	Set to 1, enables the SMBus SCL timeout bit. Default = 0 = timeout disabled. See the Serial Bus Interface section for more information.
6	SDA Timeout	Set to 1 to enable the SMBus SDA Timeout Bit. Default = 0 = Timeout disabled. See the Serial Bus Interface section for more information.
5	Mask Local	Setting this bit to 1 masks ALERTs due to the local temperature exceeding a programmed limit. Default = 0.
4	Res	Reserved for future use.
<3:0>	Consecutive ALERT	These bits set the number of consecutive out-of-limit measurements that have to occur before an ALERT is generated. 000x = 1 001x = 2 011x = 3 111x = 4

Table 11. List of Registers

Read Address (Hex)	Write Address (Hex)	Mnemonic	Power-On Default	Comment	Lock
N/A	N/A	Address Pointer	Undefined		No
00	N/A	Local Temperature Value	0000 0000 (0x00)		No
01	N/A	Remote 1 Temperature Value High Byte	0000 0000 (0x00)	Bit 3 Conf Reg = 0	No
01	N/A	Remote 2 Temperature Value High Byte	0000 0000 (0x00)	Bit 3 Conf Reg = 1	No
02	N/A	Status Register 1	Undefined		No
03	09	Configuration Register 1	0000 0000 (0x00)		Yes
04	0A	Conversion Rate/Channel Selector	0000 0111 (0x07)		Yes
05	0B	Local Temperature High Limit	0101 0101 (0x55) (85°C)		Yes
06	0C	Local Temperature Low Limit	0000 0000 (0x00) (0°C)		Yes
07	0D	Remote 1 Temp High Limit High Byte	0101 0101 (0x55) (85°C)	Bit 3 Conf Reg = 0	Yes
07	0D	Remote 2 Temp High Limit High Byte	0101 0101 (0x55) (85°C)	Bit 3 Conf Reg = 1	Yes
08	0E	Remote 1 Temp Low Limit High Byte	0000 0000 (0x00) (0°C)	Bit 3 Conf Reg = 0	Yes
08	0E	Remote 2 Temp Low Limit High Byte	0000 0000 (0x00) (0°C)	Bit 3 Conf Reg = 1	Yes
N/A	0F (Note 1)	One-Shot			N/A
10	N/A	Remote 1 Temperature Value Low Byte	0000 0000	Bit 3 Conf Reg = 0	No
10	N/A	Remote 2 Temperature Value Low Byte	0000 0000	Bit 3 Conf Reg = 1	No
11	11	Remote 1 Temperature Offset High Byte	0000 0000	Bit 3 Conf Reg = 0	Yes
11	11	Remote 2 Temperature Offset High Byte	0000 0000	Bit 3 Conf Reg = 1	Yes
12	12	Remote 1 Temperature Offset Low Byte	0000 0000	Bit 3 Conf Reg = 0	Yes
12	12	Remote 2 Temperature Offset Low Byte	0000 0000	Bit 3 Conf Reg = 1	Yes
13	13	Remote 1 Temp High Limit Low Byte	0000 0000	Bit 3 Conf Reg = 0	Yes
13	13	Remote 2 Temp High Limit Low Byte	0000 0000	Bit 3 Conf Reg = 1	Yes
14	14	Remote 1 Temp Low Limit Low Byte	0000 0000	Bit 3 Conf Reg = 0	Yes
14	14	Remote 2 Temp Low Limit Low Byte	0000 0000	Bit 3 Conf Reg = 1	Yes
19	19	Remote 1 THERM Limit	0101 0101 (0x55) (85°C)	Bit 3 Conf Reg = 0	Yes
19	19	Remote 2 THERM Limit	0101 0101 (0x55) (85°C)	Bit 3 Conf Reg = 1	Yes
20	20	Local THERM Limit	0101 0101 (0x55) (85°C)		Yes

Table 11. List of Registers

Read Address (Hex)	Write Address (Hex)	Mnemonic	Power-On Default	Comment	Lock
21	21	THERM Hysteresis	0000 1010 (0x0A) (10°C)		Yes
22	22	Consecutive ALERT	0000 0001 (0x01)		Yes
23	N/A	Status Register 2	0000 0000 (0x00)		No
24	24	Configuration 2 Register	0000 0000 (0x00)		Yes
30	N/A	Remote 2 Temperature Value High Byte	0000 0000 (0x00)		No
31	31	Remote 2 Temp High Limit High Byte	0101 0101 (0x55) (85°C)		Yes
32	32	Remote 2 Temp Low Limit High Byte	0000 0000 (0x00) (0°C)		Yes
33	N/A	Remote 2 Temperature Value Low Byte	0000 0000 (0x00)		No
34	34	Remote 2 Temperature Offset High Byte	0000 0000 (0x00)		Yes
35	35	Remote 2 Temperature Offset Low Byte	0000 0000 (0x00)		Yes
36	36	Remote 2 Temp High Limit Low Byte	0000 0000 (0x00) (0°C)		Yes
37	37	Remote 2 Temp Low Limit Low Byte	0000 0000 (0x00) (0°C)		Yes
39	39	Remote 2 THERM Limit	0101 0101 (0x55) (85°C)		Yes
3D	N/A	Device ID	1000 0001 (0x81)		
3E	N/A	Manufacturer ID	0100 0001 (0x41)		N/A

- Writing to Address 0F causes the ADT7481 to perform a single measurement. It is not a data register as such, and it does not matter what data is written to it.

Serial Bus Interface

Control of the ADT7481 is achieved via the serial bus. The ADT7481 is connected to this bus as a slave device under the control of a master device.

The ADT7481 has an SMBus timeout feature. When this is enabled, the SMBus will typically timeout after 25 ms of no activity. However, this feature is not enabled by default. Set Bit 7 (SCL timeout bit) of the consecutive alert register (Address 0x22) to enable the SCL timeout. Set Bit 6 (SDA timeout bit) of the consecutive alert register (Address 0x22) to enable the SDA timeout.

The ADT7481 supports packet error checking (PEC) and its use is optional. It is triggered by supplying the extra clock for the PEC byte. The PEC byte is calculated using CRC-8. The frame check sequence (FCS) conforms to CRC-8 by the polynomial:

$$C(x) = x^8 + x^2 + x^1 + 1 \quad (\text{eq. 1})$$

Consult the SMBus 1.1 specification for more information (www.smbus.org).

Addressing the Device

In general, every SMBus device has a 7-bit device address, except for some devices that have extended, 10-bit addresses. When the master device sends a device address over the bus, the slave device with that address responds. The ADT7481 is available with one device address, 0x4C (1001 100b). An ADT7481-1 is also available. The only difference between the ADT7481 and the ADT7481-1 is the SMBus address. The ADT7481-1 has a fixed SMBus address of 0x4B (1001 011b). The addresses mentioned in this datasheet are 7-bit addresses. The R/W bit needs to be added to arrive at an 8-bit address. Other than the different

SMBus addresses, the ADT7481 and the ADT7481-1 are functionally identical.

The serial bus protocol operates as follows:

The master initiates data transfer by establishing a start condition, defined as a high-to-low transition on the serial data line (SDATA) while the serial clock line (SCLK) remains high. This indicates that an address/data stream follows. All slave peripherals connected to the serial bus respond to the start condition and shift in the next eight bits, consisting of a 7-bit address (MSB first) plus a R/W bit, which determines the direction of the data transfer, that is, whether data will be written to, or read from, the slave device. The peripheral with the address corresponding to the transmitted address responds by pulling the data line low during the low period before the ninth clock pulse, known as the acknowledge bit. All other devices on the bus remain idle while the selected device waits for data to be read from or written to it. If the R/W bit is 0, the master writes to the slave device. If the R/W bit is 1, the master reads from the slave device.

Data is sent over the serial bus in a sequence of nine clock pulses, eight bits of data followed by an acknowledge bit from the slave device. Transitions on the data line must occur during the low period of the clock signal and remain stable during the high period, since a low-to-high transition when the clock is high may be interpreted as a stop signal. The number of data bytes that can be transmitted over the serial bus in a single read or write operation is limited only by what the master and slave devices can handle.

When all data bytes have been read or written, stop conditions are established. In write mode, the master will pull the data line high during the tenth clock pulse to assert

a stop condition. In read mode, the master device will override the acknowledge bit by pulling the data line high during the low period before the ninth clock pulse. This is known as no acknowledge. The master will then take the data line low during the low period before the tenth clock pulse, then high during the tenth clock pulse to assert a stop condition.

Any number of bytes of data may be transferred over the serial bus in one operation, but it is not possible to mix read and write in one operation because the type of operation is determined at the beginning and cannot subsequently be changed without starting a new operation. In the case of the ADT7481, write operations contain either one or two bytes, while read operations contain one byte.

To write data to one of the device data registers or to read data from it, the address pointer register must be set so that the correct data register is addressed. The first byte of a write operation always contains a valid address that is stored in the address pointer register. If data is to be written to the device, the write operation contains a second data byte that is written to the register selected by the address pointer register.

This procedure is illustrated in Figure 15. The device address is sent over the bus followed by R/W set to 0 and followed by two data bytes. The first data byte is the address of the internal data register to be written to, which is stored in the address pointer register. The second data byte is the data to be written to the internal data register.

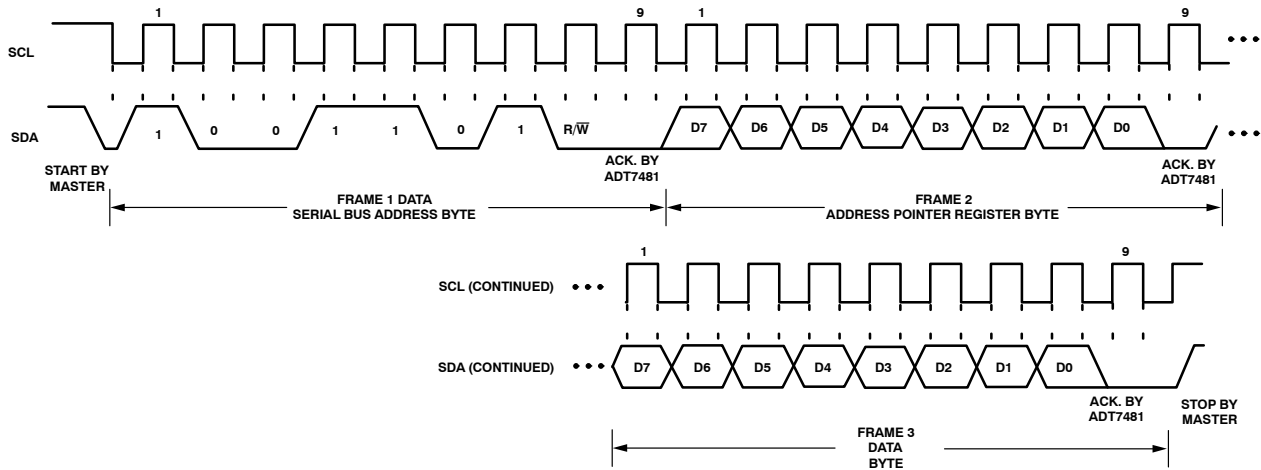

Figure 15. Writing a Register Address to the Address Pointer Register, then Writing Data to the Selected Register

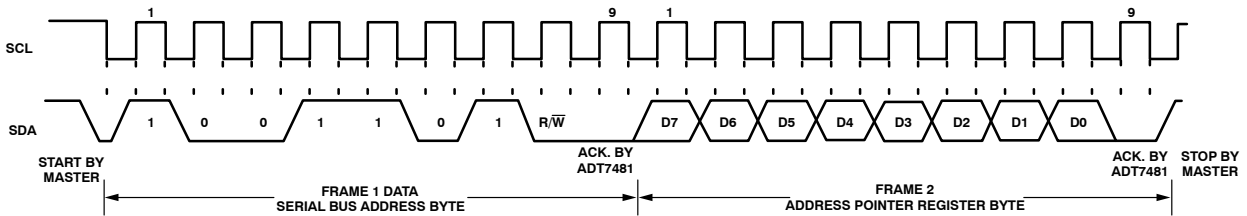

Figure 16. Writing to the Address Pointer Register Only

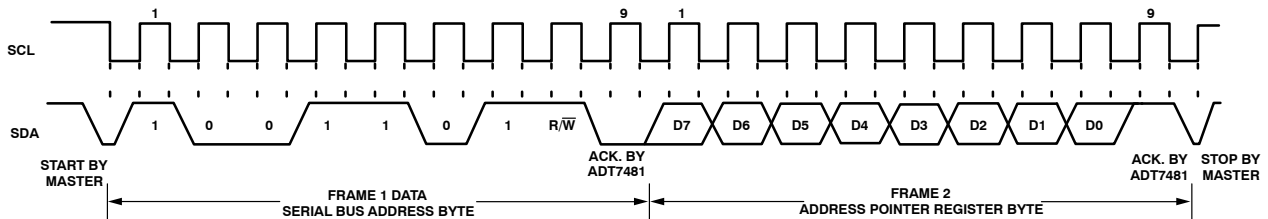

Figure 17. Reading from a Previously Selected Register

When reading data from a register there are two possible scenarios:

- If the address pointer register value of the ADT7481 is unknown or not the desired value, it is necessary to set it to the correct value before data can be read from the desired data register. This is done by performing a write to the ADT7481 as before, but only the data byte containing the register read address is sent, as data is not to be written to the register. This is shown in Figure 16.

A read operation is then performed consisting of the serial bus address, R/W bit set to 1, followed by the data byte read from the data register (shown in Figure 17).

- If the address pointer register is already at the desired address, data can be read from the corresponding data register without first writing to the address pointer register, and the bus transaction shown in Figure 16 can be omitted.

NOTES: It is possible to read a data byte from a data register without first writing to the address pointer register. However, if the address pointer register is already at the correct value, it is not possible to write data to a register without writing to the address pointer register. This is because the first data byte of a write is always written to the address pointer register.

Remember that some of the ADT7481 registers have different addresses for read and write operations. The write address of a register must be written to the address pointer if data is to be written to that register, but it may not be possible to read data from that address. The read address of a register must be written to the address pointer before data can be read from that register.

ALERT Output

Pin 8 can be configured as an $\overline{\text{ALERT}}$ output. The $\overline{\text{ALERT}}$ output goes low whenever an out-of-limit measurement is detected, or if the remote temperature sensor is open circuit. It is an open-drain output and requires a pullup. Several $\overline{\text{ALERT}}$ outputs can be wire-OR'ed together, so that the common line will go low if one or more of the $\overline{\text{ALERT}}$ outputs goes low.

The $\overline{\text{ALERT}}$ output can be used as an interrupt signal to a processor, or it may be used as an $\overline{\text{SMBALERT}}$. Slave devices on the SMBus cannot normally signal to the bus master that they want to talk, but the $\overline{\text{SMBALERT}}$ function allows them to do so.

One or more $\overline{\text{ALERT}}$ outputs can be connected to a common $\overline{\text{SMBALERT}}$ line connected to the master. When

the $\overline{\text{SMBALERT}}$ line is pulled low by one of the devices, the following procedure occurs as illustrated in Figure 18.

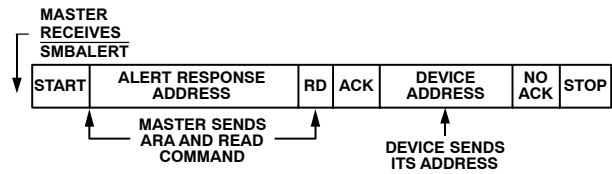

Figure 18. Use of $\overline{\text{SMBALERT}}$

1. $\overline{\text{SMBALERT}}$ is pulled low.
2. Master initiates a read operation and sends the alert response address (ARA = 0001 100). This is a general call address that must not be used as a specific device address.
3. The device with a low $\overline{\text{ALERT}}$ output responds to the alert response address, and the master reads the address from the responding device. An LSB of 1 is added because the device address is comprised of seven bits. The address of the device is now known and it can be interrogated in the usual way.
4. If more than one device has a low $\overline{\text{ALERT}}$ output, the one with the lowest device address will have priority, in accordance with normal SMBus arbitration.
5. Once the ADT7481 has responded to the alert response address, it will reset its $\overline{\text{ALERT}}$ output, provided that the error condition that caused the $\overline{\text{ALERT}}$ no longer exists. If the $\overline{\text{SMBALERT}}$ line remains low, the master sends the ARA again, and so on until all devices with low $\overline{\text{ALERT}}$ outputs respond.

Masking the $\overline{\text{ALERT}}$ Output

The $\overline{\text{ALERT}}$ output can be masked for local, Remote 1, Remote 2 or all three channels. This is done by setting the appropriate mask bits in either the Configuration 1 register (read address = 0x03, write address = 0x09) or in the consecutive $\overline{\text{ALERT}}$ register (address = 0x22)

To mask $\overline{\text{ALERT}}$ s due to local temperature, set Bit 5 of the consecutive $\overline{\text{ALERT}}$ register to 1. Default = 0.

To mask $\overline{\text{ALERT}}$ s due to Remote 1 temperature, set Bit 1 of the Configuration 1 register to 1. Default = 0.

To mask $\overline{\text{ALERT}}$ s due to Remote 2 temperature, set Bit 0 of the Configuration 1 register to 1. Default = 0.

To mask $\overline{\text{ALERT}}$ s due to any channel, set Bit 7 of the Configuration 1 register to 1. Default = 0.

Low Power Standby Mode

The ADT7481 can be put into low power standby mode by setting Bit 6 (Mon/STBY bit) of the Configuration 1 register (Read Address 0x03, Write Address 0x09) to 1. The ADT7481 operates normally when Bit 6 is 0. When Bit 6 is 1, the ADC is inhibited, and any conversion in progress is terminated without writing the result to the corresponding value register.

The SMBus is still enabled in low power standby mode. Power consumption in this standby mode is reduced to a typical of 5 μ A if there is no SMBus activity, or up to 30 μ A if there are clock and data signals on the bus.

When the device is in standby mode, it is still possible to initiate a one-shot conversion of both channels by writing to the one-shot register (Address 0x0F), after which the device will return to standby. It does not matter what is written to the one-shot register, all data written to it is ignored. It is also possible to write new values to the limit register while in standby mode. $\overline{\text{ALERT}}$ and $\overline{\text{THERM}}$ are not available in standby mode and, therefore, should not be used because the state of these pins is unreliable.

Sensor Fault Detection

The ADT7481 has internal sensor fault detection circuitry at its D+ input. This circuit can detect situations where a remote diode is not connected, or is incorrectly connected, to the ADT7481. If the voltage at D+ exceeds $V_{DD} - 1.0$ V (typical), it signifies an open circuit between D+ and D-, and consequently, trips the simple voltage comparator. The output of this comparator is checked when a conversion is initiated. Bit 2 (D1 open flag) of the Status Register 1 (Address 0x02) is set if a fault is detected on the Remote 1 channel. Bit 2 (D2 open flag) of the Status Register 2 (Address 0x23) is set if a fault is detected on the Remote 2 channel. If the $\overline{\text{ALERT}}$ pin is enabled, setting this flag will cause $\overline{\text{ALERT}}$ to assert low.

If a remote sensor is not used with the ADT7481, then the D+ and D- inputs of the ADT7481 need to be tied together to prevent the open flag from being continuously set.

Most temperature sensing diodes have an operating temperature range of -55°C to $+150^{\circ}\text{C}$. Above 150°C , they lose their semiconductor characteristics and approximate conductors instead. This results in a diode short, setting the open flag. The remote diode in this case no longer gives an accurate temperature measurement. A read of the temperature result register will give the last good temperature measurement. The user should be aware that while the diode fault is triggered, the temperature measurement on the remote channels is likely to be inaccurate.

Interrupt System

The ADT7481 has two interrupt outputs, $\overline{\text{ALERT}}$ and $\overline{\text{THERM}}$. Both outputs have different functions and behavior. $\overline{\text{ALERT}}$ is maskable and responds to violations of software-programmed temperature limits or an open-circuit fault on the remote diode. $\overline{\text{THERM}}$ is intended as a fail-safe interrupt output that cannot be masked.

If the Remote 1, Remote 2, or local temperature exceeds the programmed high temperature limits, or equals or exceeds the low temperature limits, the $\overline{\text{ALERT}}$ output is asserted low. An open-circuit fault on the remote diode also causes $\overline{\text{ALERT}}$ to assert. $\overline{\text{ALERT}}$ is reset when serviced by a master reading its device address, provided the error condition has gone away, and the status register has been reset.

The $\overline{\text{THERM}}$ output asserts low if the Remote 1, Remote 2, or local temperature exceeds the programmed $\overline{\text{THERM}}$ limits. The $\overline{\text{THERM}}$ temperature limits should normally be equal to or greater than the high temperature limits. $\overline{\text{THERM}}$ is automatically reset when the temperature falls back within the ($\overline{\text{THERM}}$ - hysteresis) limit. The local and remote $\overline{\text{THERM}}$ limits are set by default to 85°C . A hysteresis value can be programmed, in which case $\overline{\text{THERM}}$ will reset when the temperature falls to the limit value minus the hysteresis value. This applies to both local and remote measurement channels. The power-on hysteresis default value is 10°C , but this may be reprogrammed to any value after powerup.

The hysteresis loop on the $\overline{\text{THERM}}$ outputs is useful when $\overline{\text{THERM}}$ is used for on/off control of a fan. The user's system can be set up so that when $\overline{\text{THERM}}$ asserts, a fan can be switched on to cool the system. When $\overline{\text{THERM}}$ goes high again, the fan can be switched off. Programming a hysteresis value protects from fan jitter, a condition wherein the temperature hovers around the $\overline{\text{THERM}}$ limit, and the fan is constantly being switched on and off.

Table 12. $\overline{\text{THERM}}$ Hysteresis

$\overline{\text{THERM}}$ Hysteresis	Binary Representation
0°C	0 000 0000
1°C	0 000 0001
10°C	0 000 1010

Figure 19 shows how the $\overline{\text{THERM}}$ and $\overline{\text{ALERT}}$ outputs operate. A user may wish to use the $\overline{\text{ALERT}}$ output as a $\overline{\text{SMBALERT}}$ to signal to the host via the SMBus that the temperature has risen. The user could use the $\overline{\text{THERM}}$ output to turn on a fan to cool the system, if the temperature continues to increase. This method would ensure that there is a fail-safe mechanism to cool the system, without the need for host intervention.

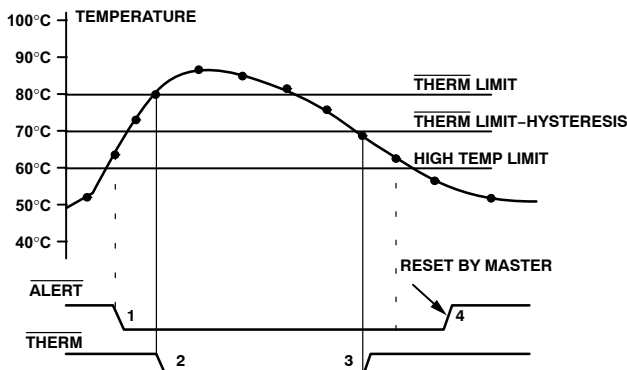

Figure 19. Operation of the $\overline{\text{ALERT}}$ and $\overline{\text{THERM}}$ Interrupts

- If the measured temperature exceeds the high temperature limit, the $\overline{\text{ALERT}}$ output will assert low.
- If the temperature continues to increase and exceeds the $\overline{\text{THERM}}$ limit, the $\overline{\text{THERM}}$ output asserts low. This can be used to throttle the CPU clock or switch on a fan.
- The $\overline{\text{THERM}}$ output de-asserts (goes high) when the temperature falls to $\overline{\text{THERM}}$ limit minus hysteresis. In Figure 19, the default hysteresis value of 10°C is shown.
- The $\overline{\text{ALERT}}$ output de-asserts only when the temperature has fallen below the high temperature limit, and the master has read the device address and cleared the status register.

Pin 8 on the ADT7481 can be configured as either an $\overline{\text{ALERT}}$ output or as an additional $\overline{\text{THERM}}$ output. $\overline{\text{THERM2}}$ will assert low when the temperature exceeds the programmed local and/or remote high temperature limits. It is reset in the same manner as $\overline{\text{THERM}}$, and it is not maskable. The programmed hysteresis value also applies to $\overline{\text{THERM2}}$.

Figure 20 shows how $\overline{\text{THERM}}$ and $\overline{\text{THERM2}}$ might operate together to implement two methods of cooling the system. In this example, the $\overline{\text{THERM2}}$ limits are set lower than the $\overline{\text{THERM}}$ limits. The $\overline{\text{THERM2}}$ output could be used to turn on a fan. If the temperature continues to rise and exceeds the $\overline{\text{THERM}}$ limits, the $\overline{\text{THERM}}$ output could provide additional cooling by throttling the CPU.

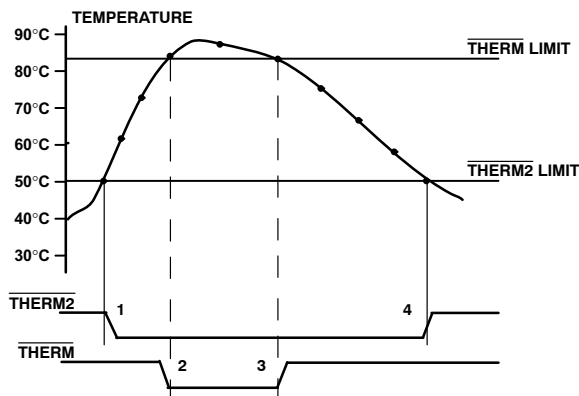

Figure 20. Operation of the $\overline{\text{THERM}}$ and $\overline{\text{THERM2}}$ Interrupts

When the $\overline{\text{THERM2}}$ limit is exceeded, the $\overline{\text{THERM2}}$ signal asserts low.

- If the temperature continues to increase and exceeds the $\overline{\text{THERM}}$ limit, the $\overline{\text{THERM}}$ output asserts low.
- , there is no hysteresis value shown.
- As the system cools further, and the temperature falls below the $\overline{\text{THERM2}}$ limit, the $\overline{\text{THERM2}}$ signal resets. Again, no hysteresis value is shown for $\overline{\text{THERM2}}$.

The temperature measurement could be either the local or the remote temperature measurement.

Applications Information

Noise Filtering

For temperature sensors operating in noisy environments, previous practice was to place a capacitor across the D+ and D- pins to help combat the effects of noise. However, large capacitances affect the accuracy of the temperature measurement, leading to a recommended maximum capacitor value of 1,000 pF.

Factors Affecting Diode Accuracy

Remote Sensing Diode

The ADT7481 is designed to work with substrate transistors built into processors or with discrete transistors. Substrate transistors will generally be PNP types with the collector connected to the substrate. Discrete types can be either a PNP or an NPN transistor connected as a diode (base shorted to collector). If an NPN transistor is used, the collector and base are connected to D+ and the emitter to D-. If a PNP transistor is used, the collector and base are connected to D- and the emitter to D+.

To reduce the error due to variations in both substrate and discrete transistors, a number of factors should be taken into consideration:

- The ideality factor, n_f , of the transistor is a measure of the deviation of the thermal diode from ideal behavior. The ADT7481 is trimmed for an n_f value of 1.008. Use the following equation to calculate the error introduced at a temperature, T (°C), when using a transistor where n_f does not equal 1.008. Consult the processor data sheet for the n_f values.

$$\Delta T = (n_f - 1.008) / 1.008 \times (273.15 \text{ Kelvin} + T) \quad (\text{eq. 2})$$

To factor this in, the user can write the ΔT value to the offset register. It will then automatically be added to, or subtracted from, the temperature measurement by the ADT7481.

- Some CPU manufacturers specify the high and low current levels of the substrate transistors. The high current level of the ADT7481, I_{HIGH} , is 233 μA . The low level current, I_{LOW} , is 14 μA . If the ADT7481 current levels do not match the current levels specified by the CPU manufacturer, it may become necessary to remove an offset. The CPU data sheet will advise whether this offset needs to be removed and how to

calculate it. This offset may be programmed to the offset register. It is important to note that if more than one offset must be considered, the algebraic sum of these offsets must be programmed to the offset register.

If a discrete transistor is being used with the ADT7481, the best accuracy is obtained by choosing devices according to the following criteria:

- Base-emitter voltage greater than 0.25 V at 6 μ A, at the highest operating temperature.
- Base-emitter voltage less than 0.95 V at 100 μ A, at the lowest operating temperature.
- Base resistance less than 100 Ω .
- Small variation in h_{FE} (say 50 to 150) that indicates tight control of V_{BE} characteristics.

Transistors, such as 2N3904, 2N3906, or equivalents in SOT-23 packages, are suitable devices to use.

Thermal Inertia and Self-Heating

Accuracy depends on the temperature of the remote sensing diode and/or the local temperature sensor being at the same temperature as that being measured. A number of factors can affect this. Ideally, the sensor should be in good thermal contact with the part of the system being measured; otherwise, the thermal inertia caused by the sensor's mass causes a lag in the response of the sensor to a temperature change.

In the case of the remote sensor, this should not be a problem, since it will either be a substrate transistor in the processor or a small package device, such as an SOT-23, placed in close proximity to it.

The on-chip sensor, however, will often be remote from the processor and only monitors the general ambient temperature around the package. In practice, the ADT7481 package will be in electrical, and hence, thermal contact with a PCB and may also be in a forced airflow. How accurately the temperature of the board and/or the forced airflow reflects the temperature to be measured will also affect the accuracy of the measurement. Self-heating, due to the power dissipated in the ADT7481 or the remote sensor, causes the chip temperature of the device (or remote sensor) to rise above ambient. However, the current forced through the remote sensor is so small that self-heating is negligible. The worst-case condition occurs when the ADT7481 is converting at 64 conversions per second while sinking the maximum current of 1 mA at the $\overline{\text{ALERT}}$ and $\overline{\text{THERM}}$ output. In this case, the total power dissipation in the device is about 4.5 mW. The thermal resistance, θ_{JA} , of the MSOP-10 package is about 142°C/W.

Layout Considerations

Digital boards can be electrically noisy environments, and the ADT7481 measures very small voltages from the remote sensor, so care must be taken to minimize noise induced at the sensor inputs. Take the following precautions:

- Place the ADT7481 as close as possible to the remote sensing diode. Provided that the worst noise sources such as clock generators, data/address buses, and CRTs are avoided, this distance can range from 4 to 8 inches.
- Route the D+ and D- tracks close together, in parallel, with grounded guard tracks on each side. To minimize inductance and reduce noise pick up, a 5 mil track width and spacing is recommended. Provide a ground plane under the tracks if possible.



Figure 21. Typical Arrangement of Signal Tracks

- Try to minimize the number of copper/solder joints that can cause thermocouple effects. Where copper/solder joints are used, make sure that they are in both the D+ and D- path and at the same temperature.
- Thermocouple effects should not be a major problem as 1°C corresponds to about 200 mV, and thermocouple voltages are about 3 mV/°C of temperature difference.
- Unless there are two thermocouples with a large temperature differential between them, thermocouple voltages should be much less than 200 mV.
- Place a 0.1 μ F bypass capacitor close to the V_{DD} pin. In extremely noisy environments, an input filter capacitor may be placed across D+ and D- close to the ADT7481. This capacitance can affect the temperature measurement, so care must be taken to ensure that any capacitance seen at D+ and D- is a maximum of 1,000 pF. This maximum value includes the filter capacitance, plus any cable or stray capacitance between the pins and the sensor diode.
- If the distance to the remote sensor is more than 8 inches, the use of twisted pair cable is recommended. A total of 6 feet to 12 feet of cable is needed.
- For really long distances (up to 100 feet), use shielded twisted pair, such as Belden No. 8451 microphone cable. Connect the twisted pair to D+ and D- and the shield to GND close to the ADT7481. Leave the remote end of the shield unconnected to avoid ground loops. Because the measurement technique uses switched current sources, excessive cable or filter capacitance can affect the measurement. When using long cables, the filter capacitance can be reduced or removed.

ADT7481

Application Circuit

Figure 22 shows a typical application circuit for the ADT7481, using discrete sensor transistors. The pullups on SCLK, SDATA, and $\overline{\text{ALERT}}$ are required only if they are not already provided elsewhere in the system.

The SCLK and SDATA pins of the ADT7481 can be interfaced directly to the SMBus of an I/O controller, such as the Intel® 820 chipset.

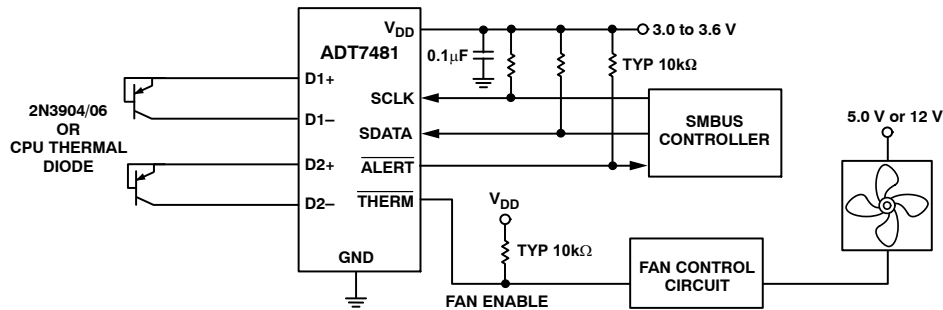

Figure 22. Typical Application Circuit

ORDERING INFORMATION

Device Order Number*	Package Type	Shipping†	Branding	SMBus Address
ADT7481ARMZ	10-Lead MSOP	50 Tube	T08	4C
ADT7481ARMZ-REEL	10-Lead MSOP	3000 Tape & Reel	T08	4C
ADT7481ARMZ-R7	10-Lead MSOP	1000 Tape & Reel	T08	4C
ADT7481ARMZ-001	10-Lead MSOP	50 Tube	T0M	4B
ADT7481ARMZ-1RL	10-Lead MSOP	3000 Tape & Reel	T0M	4B
ADT7481ARMZ-1R7	10-Lead MSOP	1000 Tape & Reel	T0M	4B

†For information on tape and reel specifications, including part orientation and tape sizes, please refer to our Tape and Reel Packaging Specifications Brochure, BRD8011/D.

*The "Z" suffix indicates Pb-Free package available.

ADT7481

PACKAGE DIMENSIONS

MSOP10 CASE 846AC-01 ISSUE 0

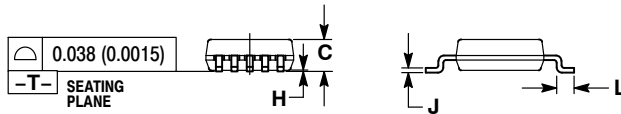
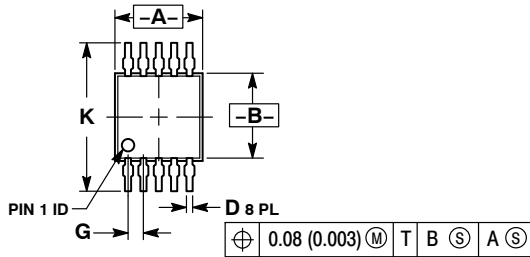

NOTES:

1. DIMENSIONING AND TOLERANCING PER ANSI Y14.5M, 1982.
2. CONTROLLING DIMENSION: MILLIMETER.
3. DIMENSION "A" DOES NOT INCLUDE MOLD FLASH, PROTRUSIONS OR GATE BURRS. MOLD FLASH, PROTRUSIONS OR GATE BURRS SHALL NOT EXCEED 0.15 (0.006) PER SIDE.
4. DIMENSION "B" DOES NOT INCLUDE INTERLEAD FLASH OR PROTRUSION. INTERLEAD FLASH OR PROTRUSION SHALL NOT EXCEED 0.25 (0.010) PER SIDE.
5. 846B-01 OBSOLETE. NEW STANDARD 846B-02

DIM	MILLIMETERS		INCHES	
	MIN	MAX	MIN	MAX
A	2.90	3.10	0.114	0.122
B	2.90	3.10	0.114	0.122
C	0.95	1.10	0.037	0.043
D	0.20	0.30	0.008	0.012
G	0.50 BSC		0.020 BSC	
H	0.05	0.15	0.002	0.006
J	0.10	0.21	0.004	0.008
K	4.75	5.05	0.187	0.199
L	0.40	0.70	0.016	0.028

SOLDERING FOOTPRINT*

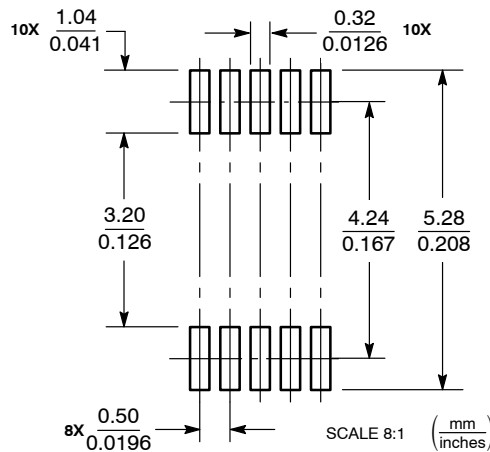

*For additional information on our Pb-Free strategy and soldering details, please download the ON Semiconductor Soldering and Mounting Techniques Reference Manual, SOLDERRM/D.

Protected by U.S. Patents 5,195,827; 5,867,012, 5,982,221; 6,097,239; 6,133,753; 6,169,442, other patents pending.

ON Semiconductor and are registered trademarks of Semiconductor Components Industries, LLC (SCILLC). SCILLC reserves the right to make changes without further notice to any products herein. SCILLC makes no warranty, representation or guarantee regarding the suitability of its products for any particular purpose, nor does SCILLC assume any liability arising out of the application or use of any product or circuit, and specifically disclaims any and all liability, including without limitation special, consequential or incidental damages. "Typical" parameters which may be provided in SCILLC data sheets and/or specifications can and do vary in different applications and actual performance may vary over time. All operating parameters, including "Typicals" must be validated for each customer application by customer's technical experts. SCILLC does not convey any license under its patent rights nor the rights of others. SCILLC products are not designed, intended, or authorized for use as components in systems intended for surgical implant into the body, or other applications intended to support or sustain life, or for any other application in which the failure of the SCILLC product could create a situation where personal injury or death may occur. Should Buyer purchase or use SCILLC products for any such unintended or unauthorized application, Buyer shall indemnify and hold SCILLC and its officers, employees, subsidiaries, affiliates, and distributors harmless against all claims, costs, damages, and expenses, and reasonable attorney fees arising out of, directly or indirectly, any claim of personal injury or death associated with such unintended or unauthorized use, even if such claim alleges that SCILLC was negligent regarding the design or manufacture of the part. SCILLC is an Equal Opportunity/Affirmative Action Employer. This literature is subject to all applicable copyright laws and is not for resale in any manner.

PUBLICATION ORDERING INFORMATION

LITERATURE FULFILLMENT:
Literature Distribution Center for ON Semiconductor
P.O. Box 5163, Denver, Colorado 80217 USA
Phone: 303-675-2175 or 800-344-3860 Toll Free USA/Canada
Fax: 303-675-2176 or 800-344-3867 Toll Free USA/Canada
Email: orderlit@onsemi.com

N. American Technical Support: 800-282-9855 Toll Free USA/Canada
Europe, Middle East and Africa Technical Support:
Phone: 421 33 790 2910
Japan Customer Focus Center
Phone: 81-3-5773-3850

ON Semiconductor Website: www.onsemi.com
Order Literature: <http://www.onsemi.com/orderlit>
For additional information, please contact your local Sales Representative