

Features

- Low Noise Figure
- High IP₃
- Single +3 V to +5 V Supply Voltage
- Lead-Free SOT-89 Package
- 100% Matte Tin Plating over Copper
- Halogen-Free “Green” Mold Compound
- RoHS* Compliant and 260°C Re-flow Compatible

Description

M/A-COM's MAALSS0034 broadband gain stage is a GaAs MMIC amplifier in a lead-free SOT-89 surface mount plastic package. It can be operated from a single 3 to 5 volt supply.

The MAALSS0034 employs a monolithic single-stage self-biased design featuring a convenient 50-ohm input impedance that minimizes the number of external components required. The broadband design provides low noise figure and high IP3 from 70 to 3000 MHz.

M/A-COM fabricates the MAALSS0034 using an E/D MESFET process to realize low noise and high dynamic range. The process features full passivation for performance and reliability.

Ordering Information^{1,2}

Part Number	Package
MAALSS0034	Bulk Packaging
MAALSS0034TR-3000	3000 piece reel
MAALSS0034SMB	Sample Test Board

1. Reference Application Note M513 for reel size information.
2. All sample boards include 5 loose parts.

Functional Block Diagram

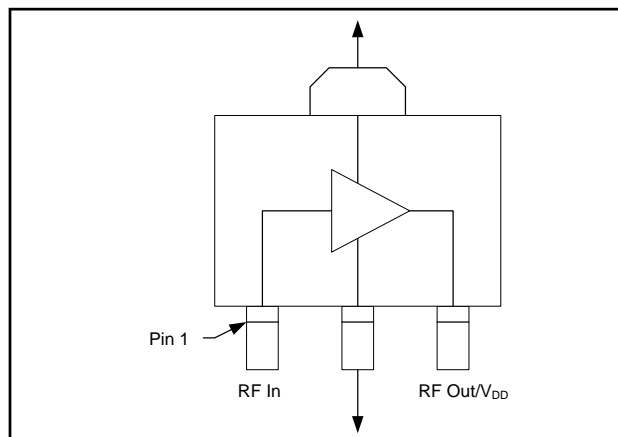

Pin Configuration

Pin	Pin Name	Description
1	RF In	RF Input
2	GND	Ground
3	RF Out/V _{DD}	RF Output & Voltage Bias

Maximum Operating Conditions³

Parameter	Maximum Operating Condition
RF Output Power	23 dBm
Junction Temperature ⁴	150°C
Operating Temperature	-40°C to +85°C

3. Operating at or within these conditions will ensure MTTF > 1 x 10⁶ hours.
4. Typical thermal resistance (θ_{jc}) = 100°C/W.

Absolute Maximum Ratings^{5,6}

Parameter	Absolute Maximum
RF Output Power	24 dBm
Voltage	6.0 volts
Storage Temperature	-65°C to +150°C
Junction Temperature	200°C

5. Exceeding any one or combination of these limits may cause permanent damage to this device.
6. M/A-COM does not recommend sustained operation near these survivability limits.

* Restrictions on Hazardous Substances, European Union Directive 2002/95/EC.

Miniature Broadband Gain Stage 70 - 3000 MHz

Rev. V2

Electrical Specifications: $Z_0 = 50 \Omega$, $T_A = 25^\circ\text{C}$, $V_{DD} = +5\text{ V}$ (unless otherwise specified)

Parameter	Test Conditions	Units	Min.	Typ.	Max.
Gain	0.9 GHz	dB	—	14.5	—
	1.9 GHz	dB	11.0	12.0	13.0
	1.9 GHz ($V_{DD} = +3\text{V}$)	dB	10.5	11.5	13.0
	3.0 GHz	dB	—	9.20	—
Noise Figure	0.9 GHz	dB	—	1.55	—
	1.9 GHz	dB	—	1.60	2.0
	1.9 GHz ($V_{DD} = +3\text{V}$)	dB	—	1.50	2.0
	3.0 GHz	dB	—	1.70	—
Input Return Loss	0.9 GHz	dB	—	10	—
	1.9 GHz	dB	—	15	—
	3.0 GHz	dB	—	18	—
Output Return Loss	0.9 GHz	dB	—	9	—
	1.9 GHz	dB	—	14	—
	3.0 GHz	dB	—	18	—
Output P1dB	0.9 GHz	dBm	—	22	—
	1.9 GHz	dBm	—	23	—
	3.0 GHz	dBm	—	23	—
Output IP ₃	Two tone, -12 dBm/tone, 1 MHz spacing				
	0.9 GHz	dBm	—	33	—
	1.9 GHz	dBm	—	36	—
Current	$V_{DD} = +5\text{ V}$	mA	50	88	110
	$V_{DD} = +3\text{ V}$	mA	35	70	100

Application Schematic

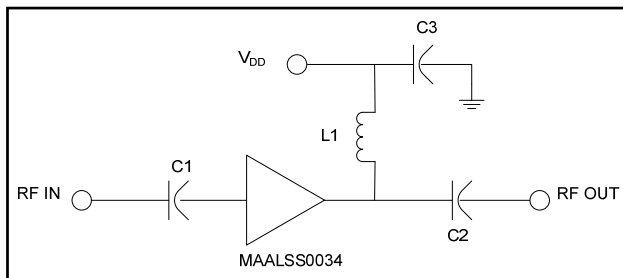

Component List ⁷, 500 - 3000 MHz

Part	Value	Case Style	Manufacturer	Purpose
C1,C2	39 pF	0402	Murata	DC Block
C3	0.1 μF	0402	Murata	RF Bypass
L1	12 nH	0402	Coilcraft	RF Choke/Tuning

7. Please contact M/A-COM application group for lower frequency application circuitry.

Recommended PCB Configuration

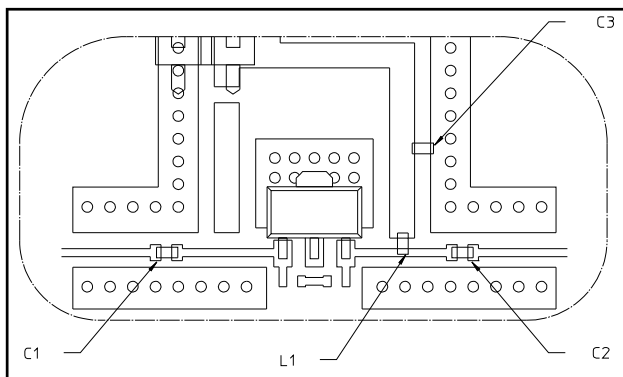

Handling Procedures

Please observe the following precautions to avoid damage:

Static Sensitivity

Gallium Arsenide Integrated Circuits are sensitive to electrostatic discharge (ESD) and can be damaged by static electricity. Proper ESD control techniques should be used when handling these devices.

ADVANCED: Data Sheets contain information regarding a product M/A-COM Technology Solutions is considering for development. Performance is based on target specifications, simulated results, and/or prototype measurements. Commitment to develop is not guaranteed.
PRELIMINARY: Data Sheets contain information regarding a product M/A-COM Technology Solutions has under development. Performance is based on engineering tests. Specifications are typical. Mechanical outline has been fixed. Engineering samples and/or test data may be available. Commitment to produce in volume is not guaranteed.

• **North America** Tel: 800.366.2266 / Fax: 978.366.2266
 • **Europe** Tel: 44.1908.574.200 / Fax: 44.1908.574.300
 • **Asia/Pacific** Tel: 81.44.844.8296 / Fax: 81.44.844.8298
 Visit www.macomtech.com for additional data sheets and product information.

M/A-COM Technology Solutions Inc. and its affiliates reserve the right to make changes to the product(s) or information contained herein without notice.

Typical Performance Curves, $V_{DD} = +5\text{ V}$

Gain

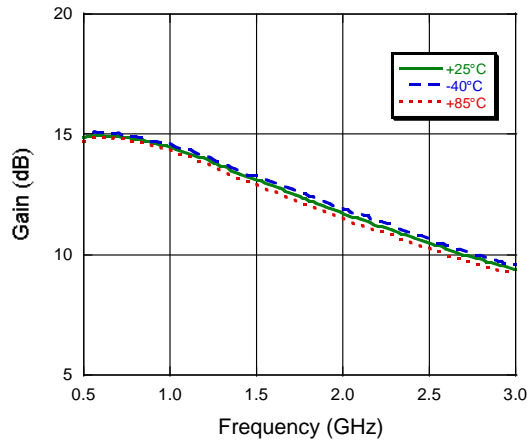

Noise Figure

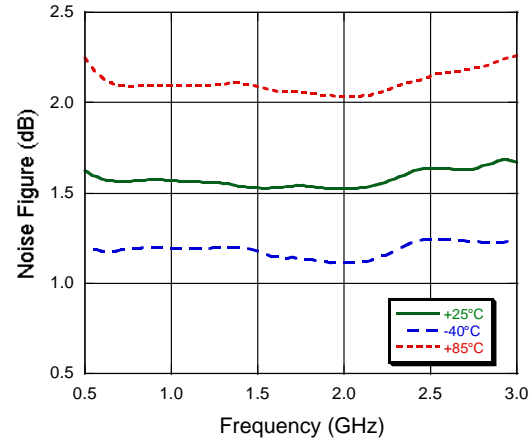

Input Return Loss

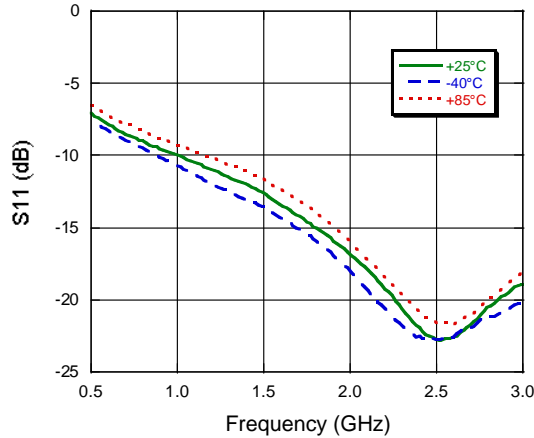

Output Return Loss

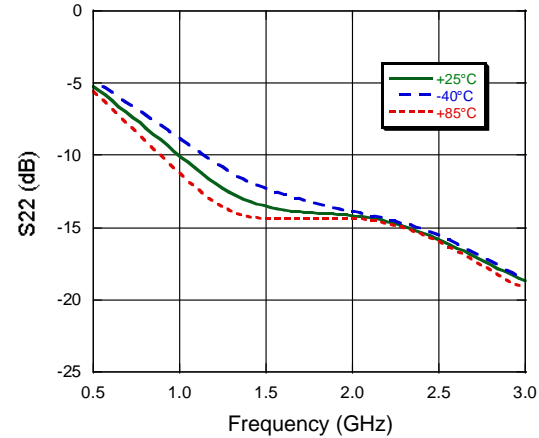

Output P1dB

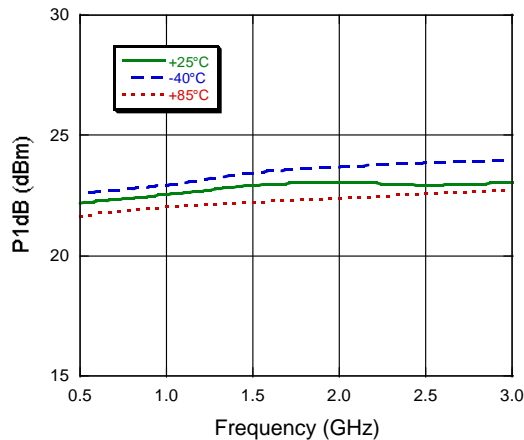

Output IP3, Input Power = -12 dBm

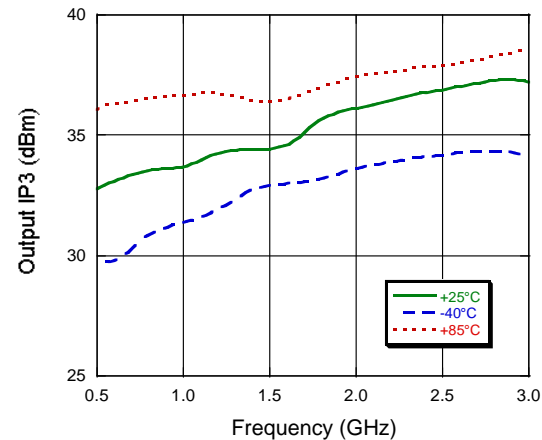

Typical Performance Curves, $V_{DD} = +3\text{ V}$

Gain

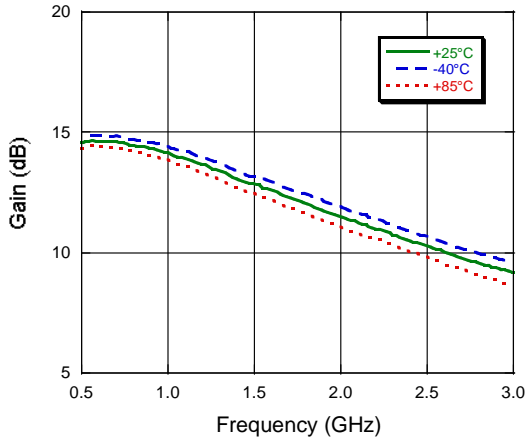

Noise Figure

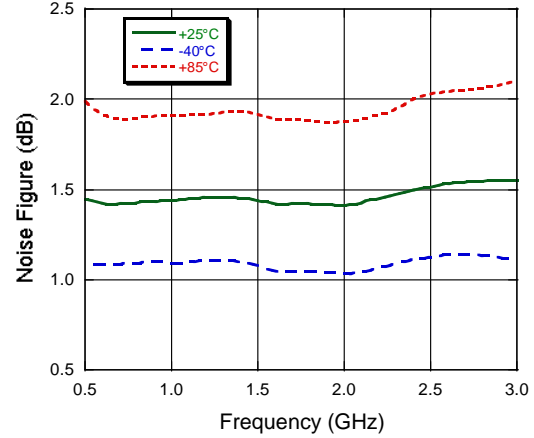

Input Return Loss

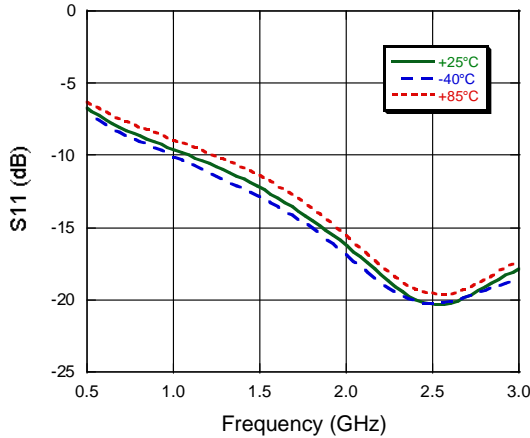

Output Return Loss

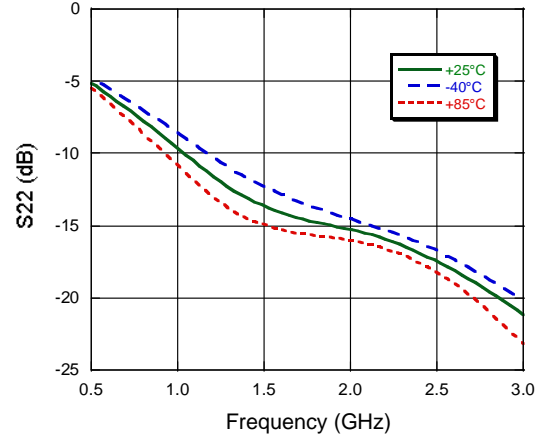

Output P1dB

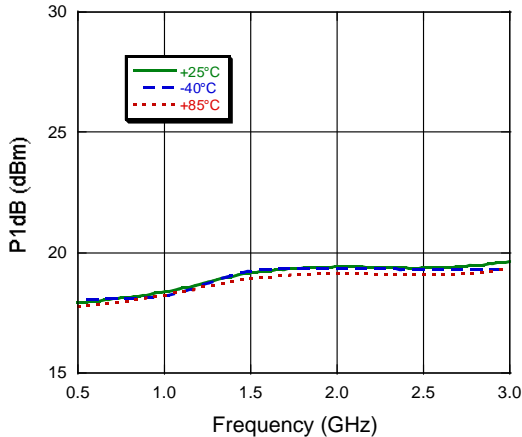

Output IP3, Input Power = -12 dBm

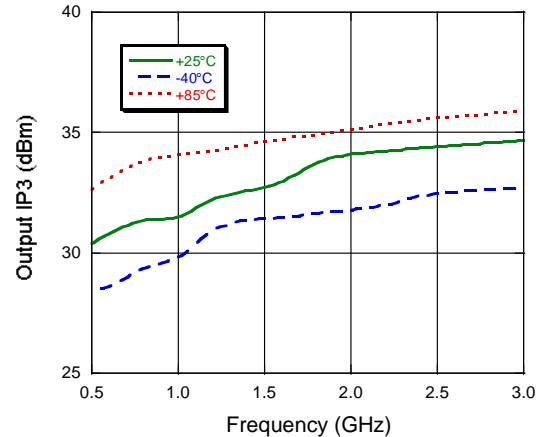

Lead-Free SOT-89†

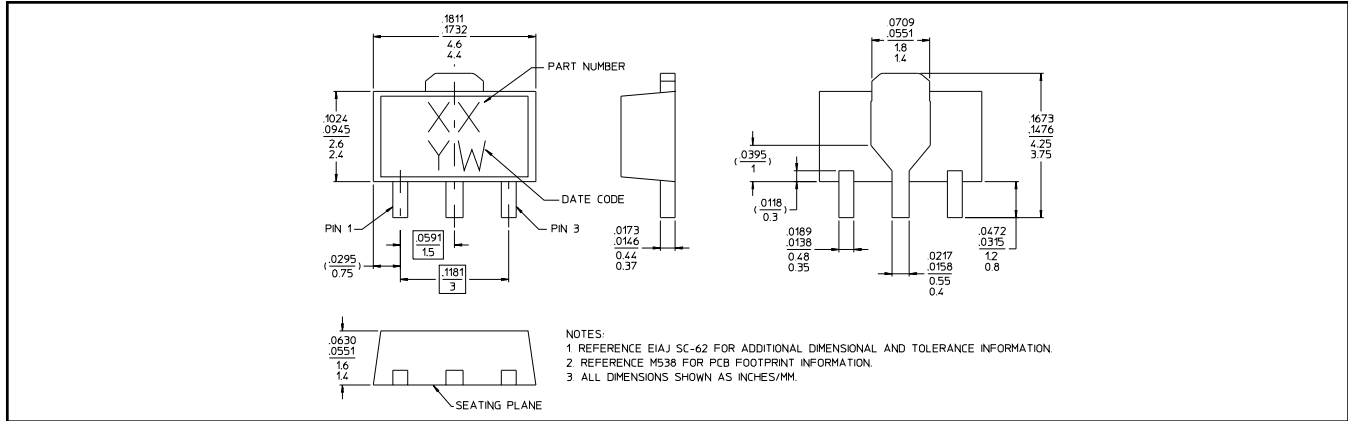

† Reference Application Note M538 for lead-free solder reflow recommendations.
Meets JEDEC moisture sensitivity level 1 requirements.