

17-27GHz Variable Gain Amplifier *Preliminary*

GaAs Monolithic Microwave IC in SMD package

Description

The CHA4693-QGG is a variable gain broadband three-stage monolithic amplifier. It is designed for a wide range of applications, typically commercial communication systems.

The circuit is manufactured with a power pHEMT process, 0.15 μ m gate length, via holes through the substrate and air bridges.

It is available in lead-free SMD package.

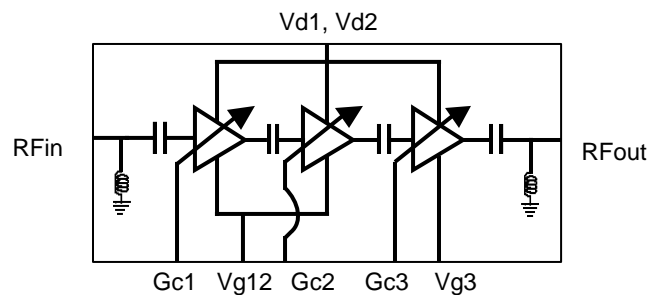
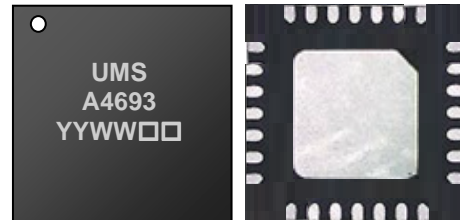

Main Features

- Broadband performance 17-27GHz
- 20dB gain
- 28dBm output IP3 @ gain max
- 24dB gain control range
- 28L-QFN5x5
- ESD protected (see page 14)

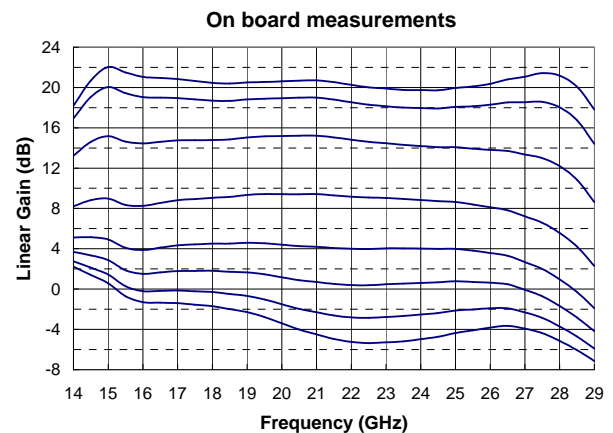

Main Characteristics

Tamb. = 25°C, Vd = 4.5V

Symbol	Parameter	Min	Typ	Max	Unit
Fop	Operating frequency range	17		27	GHz
G	Small signal gain		20		dB
Gc	Gain control range		24		dB
OIP3	Output Intercept Point order 3 @ gain max.		28		dBm

ESD Protection: Electrostatic discharge sensitive device. Observe handling precautions!

Electrical CharacteristicsTamb. = 25°C, Vd_{1,2} = 4.5V, GcX with X=1,2,3*Preliminary*

Symbol	Parameter	Min	Typ	Max	Unit
Fop	Operating frequency range	17		27	GHz
G	Nominal gain @ gain max.		20		dB
NF	Noise Figure @ gain max.		7.5		dB
	Noise Figure @ gain min.		24		dB
RLin	Input Return Loss (Fop<21GHz) (any GcX)		-9		dB
	Input Return Loss (Fop>21GHz) (any GcX)		-12		dB
RLout	Output Return Loss (Fop<21GHz) (any GcX)		-9		dB
	Output Return Loss (Fop>21GHz) (any GcX)		-12		dB
OIP3	Output 3 rd order Intercept Point @ gain max.		28		dBm
	Output 3 rd order Intercept Point @ gain min.		19		dBm
P1dB	Output Power at 1dB gain compression @ gain max.		22		dBm
Gc	Gain control range (Fop<20GHz)		22		dB
	Gain control range (Fop>20GHz)		24		dB
Vd _{1,2}	DC drain voltage		4.5		V
Id	Drain bias quiescent current (*)		250		mA
Idc	Drain current at 1dB gain compression		300		mA
Vg _{12,3}	Gate bias voltage		-1.2		V
GcX	DC gain control voltage	-2		+0,6	V

(*) Id not affected by GcX.

These values are representative of on board measurements as defined on the drawing 97365 (see page 16).

Absolute Maximum Ratings (*)

Tamb = +25°C

Symbol	Parameter	Values	Unit
Vd _{1,2}	Drain bias voltage	5	V
Id	Power supply quiescent current	300	mA
Vg	Gate bias voltage	-2 to 0	V
GcX	DC gain control voltage	-2.5 to +1	V
Pin	RF input power @ gain max.	8	dBm
Top	Operating temperature range	-40 to +85	°C
Tj	Junction temperature	175	°C
Tstg	Storage temperature range	-55 to +125	°C

(*) Operation of this device above anyone of these parameters may cause permanent damage.

Device thermal performances:

All the figures given in this section are obtained assuming that the QFN device is cooled down only by conduction through the package thermal pad (no convection mode considered).

The temperature is monitored at the package back side side interface (Tcase) as shown below.

The system maximum temperature must be adjusted in order to guarantee that Tcase remains below than the maximum value specified in the next table. So, the system PCB must be designed to comply with this requirement.

A derating must be applied on the dissipated power if the Tcase temperature can not be maintained below than the maximum temperature specified in order to guarantee the nominal device life time (MTTF) (see the curve Pdis. Max).

DEVICE THERMAL SPECIFICATION : CHA4693-QGG

Max. junction temperature (Tj max)	:	169 °C
Max. continuous dissipated power @ Tcase= 85 °C	:	1,1 W
=> Pdis derating above Tcase= 85 °C	:	13 mW/°C
Junction-Case thermal resistance (Rth J-C)*	:	<74 °C/W
Min. package back side operating temperature**	:	-40 °C
Max. package back side operating temperature**	:	85 °C
Min. storage temperature	:	-55 °C
Max. storage temperature	:	125 °C

*Rth J-C is calculated is a worst case where the hotter junction of the MMIC is considered.

**Tcase=Package back side temperature measured under the die-attach-pad.

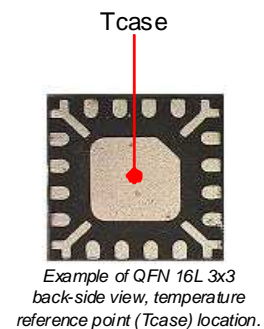
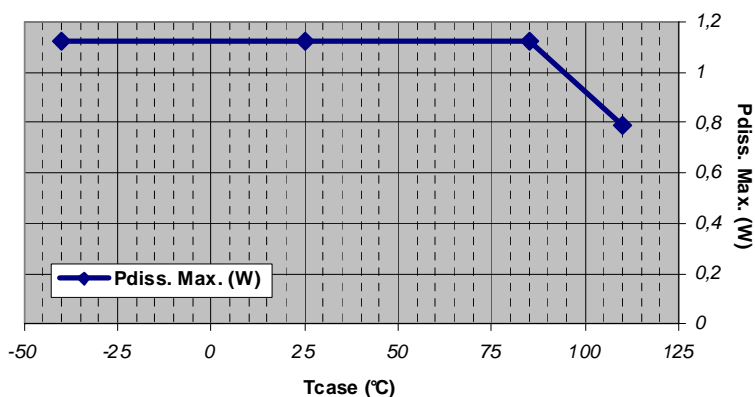

Typical Measured Performance

Preliminary

Tamb. = +25°C, Vd_{1,2} = +4.5V, Vg_{12,3} tuned for Id = 250mA

Measurements in the package access planes, using the proposed land pattern & board 97365, as defined page 16.

Linear Gain versus Frequency

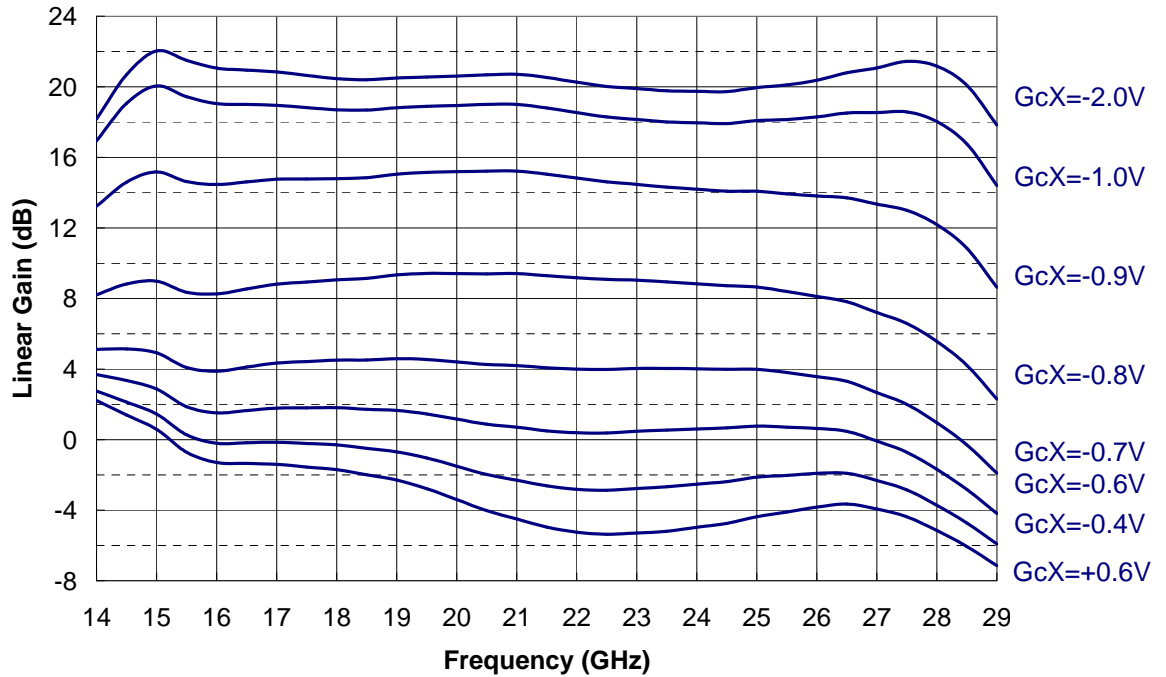

Linear Gain versus Gain Control Voltage

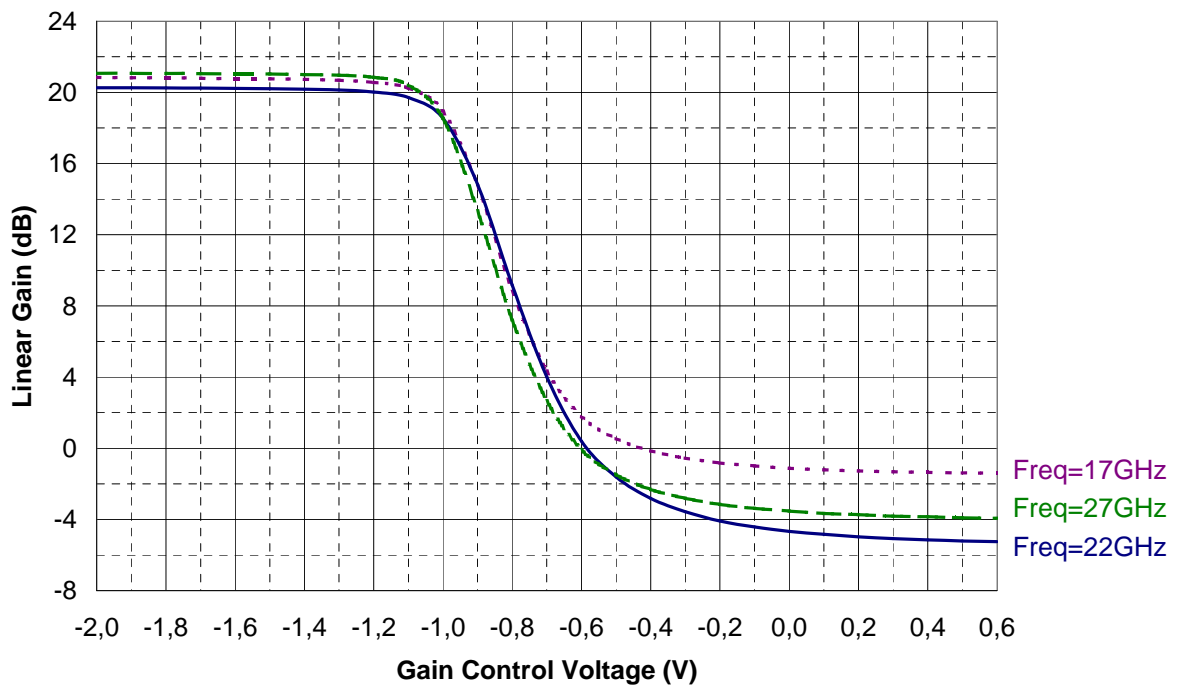

Preliminary

Gain Control Range versus Frequency

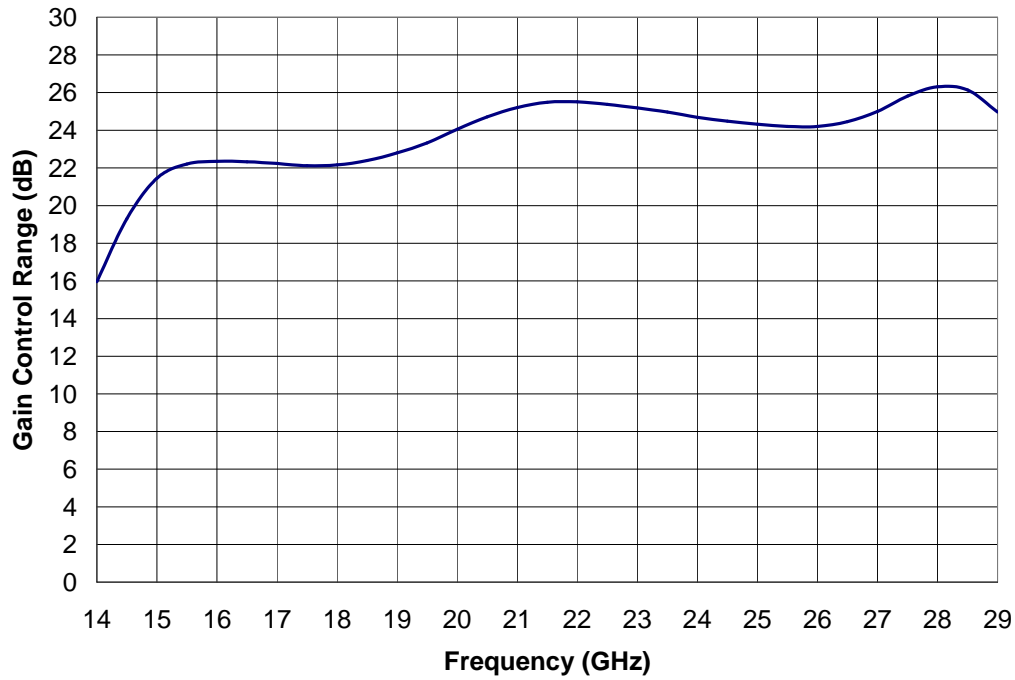

Return Losses versus Frequency and Gain Control Voltage

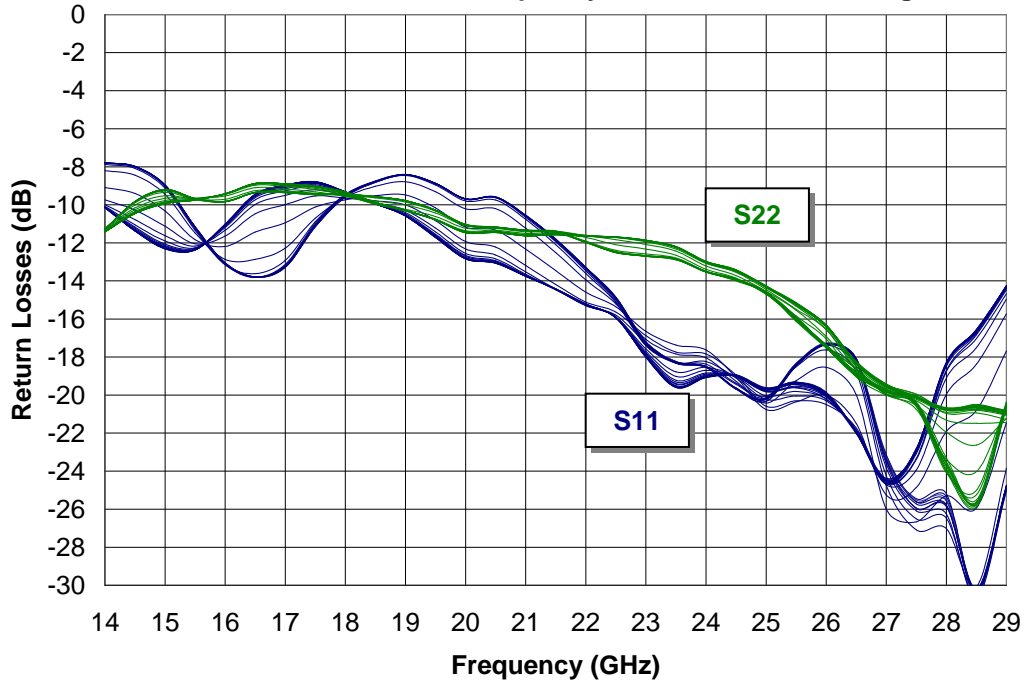

Typical Package Sij parameters for Gc1, Gc2, Gc3 = -2.0V

Preliminary

Tamb. = +25°C, Vd_{1,2} = +4.5V, Id = 250mA

Freq (GHz)	dB(S11)	Ph(S11) (°)	dB(S12)	Ph(S12) (°)	dB(S2 1)	Ph(S21) (°)	dB(S22)	Ph(S22) (°)
2,0	-1,6	105	-62,6	-93	-35,2	-166	-10,7	74
3,0	-3,2	55	-64,1	-151	-26,3	-30	-6,2	152
4,0	-6,8	-11	-84,6	64	-35,7	-141	-1,8	109
5,0	-11,6	-104	-75,6	162	-29,5	51	-1,9	74
6,0	-11,1	173	-69,7	66	-16,8	-70	-2,7	40
7,0	-9,6	125	-62,7	56	-11,8	-167	-4,0	7
8,0	-8,0	93	-62,1	5	-6,5	121	-6,5	-26
9,0	-7,6	58	-63,1	-28	-3,1	50	-10,3	-50
10,0	-8,0	23	-64,2	-90	-0,5	-16	-14,5	-61
11,0	-7,4	-10	-64,7	-128	3,5	-72	-14,9	-57
12,0	-7,8	-47	-64,2	176	7,0	-133	-14,5	-64
13,0	-7,1	-78	-70,6	-173	12,6	167	-13,2	-71
14,0	-7,8	-109	-57,9	163	18,2	92	-11,3	-78
15,0	-9,0	-134	-50,7	110	22,0	-5	-9,2	-100
16,0	-13,1	-152	-51,1	57	21,1	-99	-9,8	-119
17,0	-13,3	-132	-52,8	36	20,8	-173	-9,4	-132
17,5	-11,2	-128	-52,4	28	20,7	152	-9,5	-139
18,0	-9,6	-133	-53,6	19	20,5	118	-9,5	-144
18,5	-8,8	-146	-53,7	12	20,4	84	-9,6	-151
19,0	-8,4	-158	-53,0	0	20,5	49	-9,8	-159
19,5	-8,9	-169	-55,7	-2	20,6	13	-10,3	-165
20,0	-9,7	179	-54,9	-9	20,6	-24	-11,0	-172
20,5	-9,6	174	-58,8	-29	20,7	-58	-11,2	-176
21,0	-10,6	161	-60,3	16	20,7	-94	-11,3	-179
21,5	-11,8	150	-56,0	32	20,5	-131	-11,4	174
22,0	-13,3	137	-54,6	3	20,3	-167	-12,0	168
22,5	-14,9	134	-54,3	1	20,0	157	-12,5	162
23,0	-17,2	139	-55,6	18	19,9	122	-12,7	154
23,5	-18,3	134	-54,2	17	19,8	86	-12,9	145
24,0	-18,5	130	-52,0	33	19,8	47	-13,5	132
24,5	-19,7	132	-48,1	23	19,7	13	-13,9	121
25,0	-20,3	119	-46,1	15	20,0	-25	-14,6	102
25,5	-18,4	102	-45,0	-7	20,1	-64	-16,1	86
26,0	-17,3	81	-43,5	-7	20,4	-104	-17,4	75
26,5	-18,1	52	-43,4	-21	20,8	-148	-18,9	53
27,0	-23,1	32	-43,1	-35	21,1	167	-19,8	23
28,0	-25,6	23	-39,4	-54	21,2	60	-23,3	-37
29,0	-24,7	36	-40,6	-72	17,8	-61	-20,5	-44
30,0	-15,8	15	-40,1	-91	9,8	-178	-18,3	-103
31,0	-9,0	-28	-38,5	-111	0,8	86	-15,5	-122
32,0	-6,3	-90	-36,1	-131	-10,4	-5	-13,1	-149
33,0	-3,7	-134	-36,4	-167	-20,6	-85	-10,5	-167
34,0	-2,6	-169	-40,1	157	-29,4	-161	-7,8	178
35,0	-1,4	164	-42,7	139	-37,1	146	-5,5	160
36,0	-1,7	138	-46,8	119	-43,1	97	-4,1	142
37,0	0,4	127	-55,8	-165	-52,9	152	-2,3	128
38,0	-0,1	109	-46,0	143	-43,0	117	-1,1	112
39,0	-0,1	95	-48,7	135	-48,2	144	-0,5	99
40,0	-1,1	82	-50,9	90	-50,0	57	-0,6	87

Refer to the “definition of the Sij reference planes” section below.

Typical Measured Performance

Preliminary

Tamb. = +25°C, Vd_{1,2} = +4.5V, Vg_{12,3} tuned for Id = 250mA

Measurements in the plan of the connectors (losses not deembedded), using the proposed land pattern & board 97365, as defined page 16.

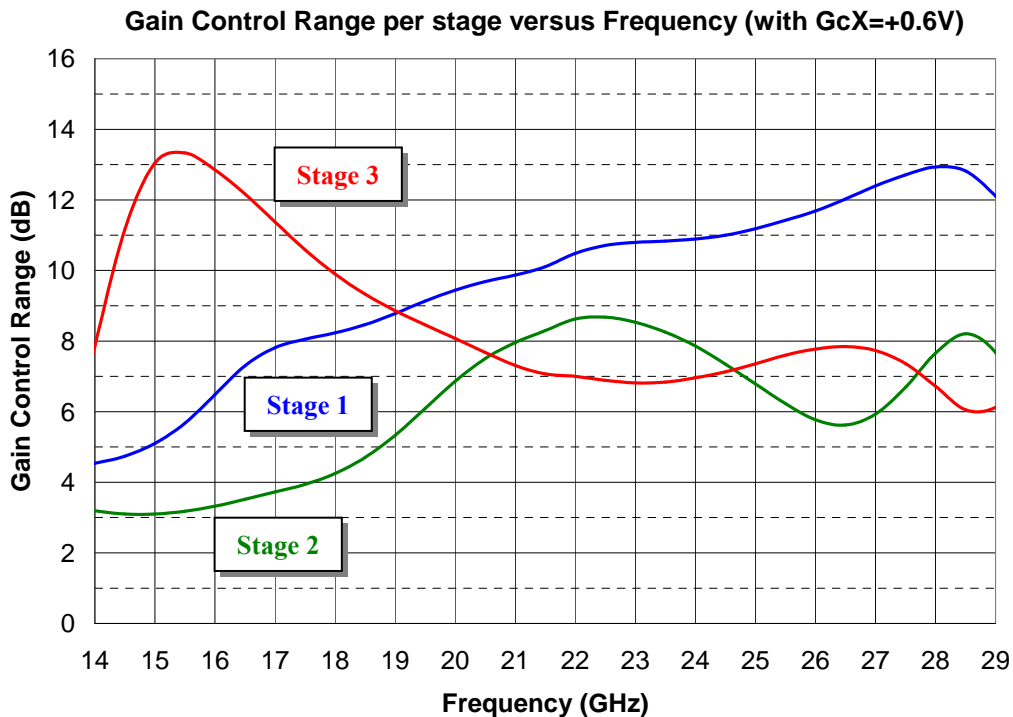
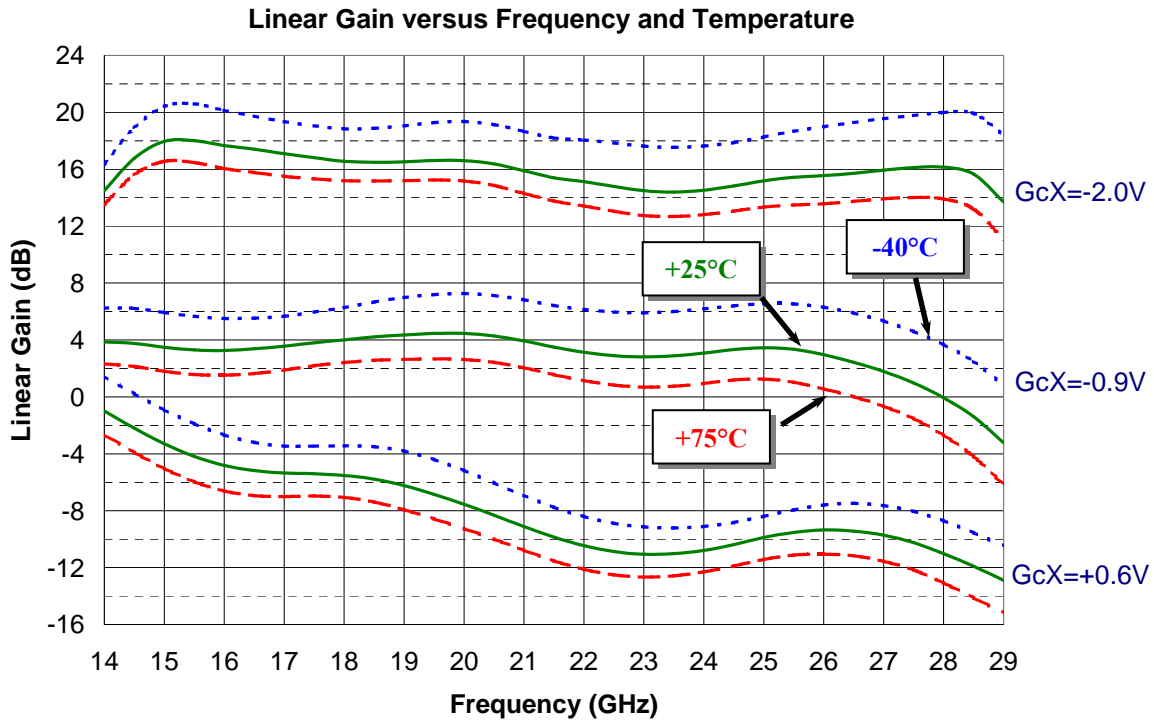

Preliminary

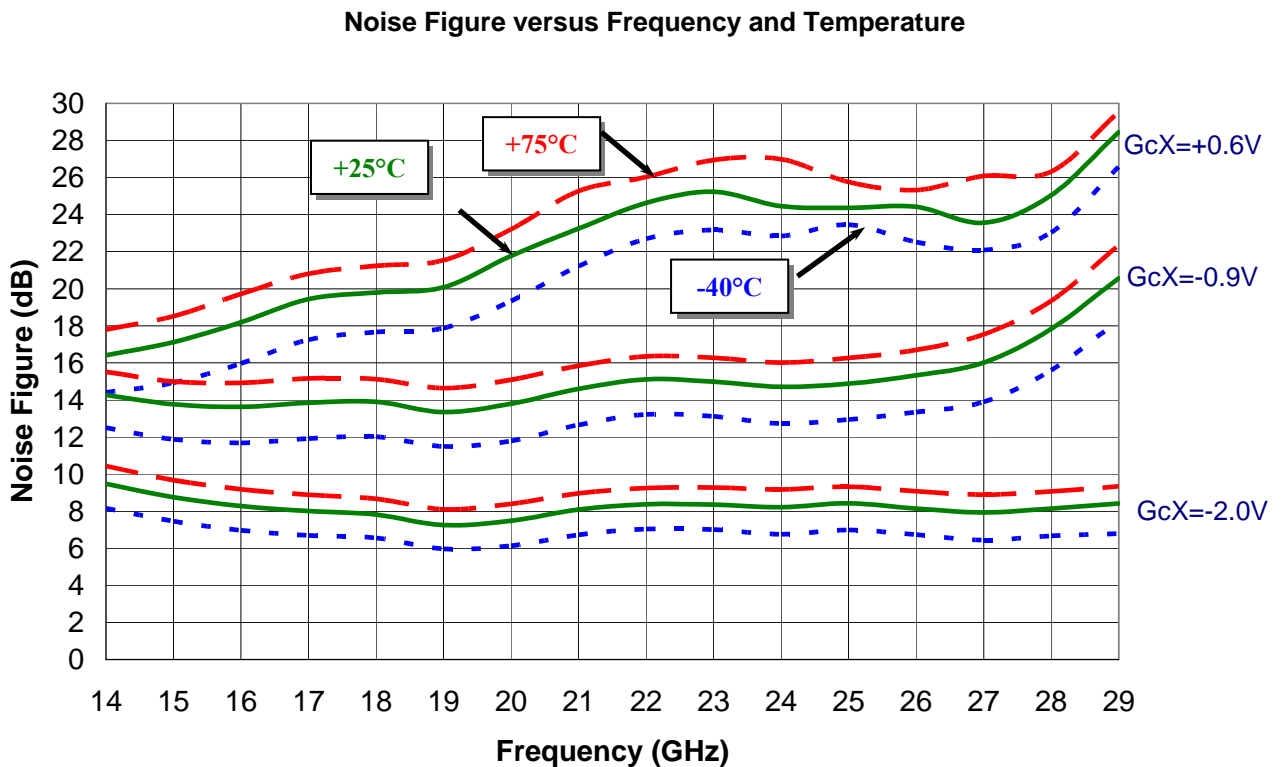
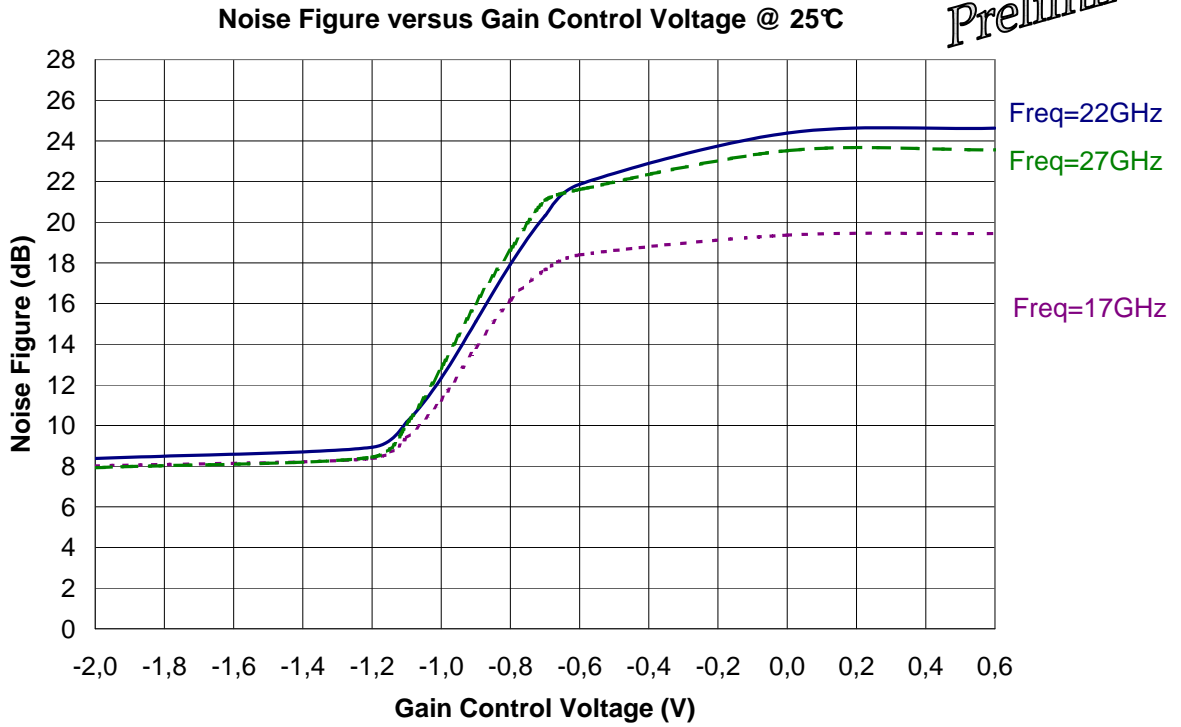

Preliminary

Output IP3 versus Dual Carrier Output Power and Temperature @ 17GHz

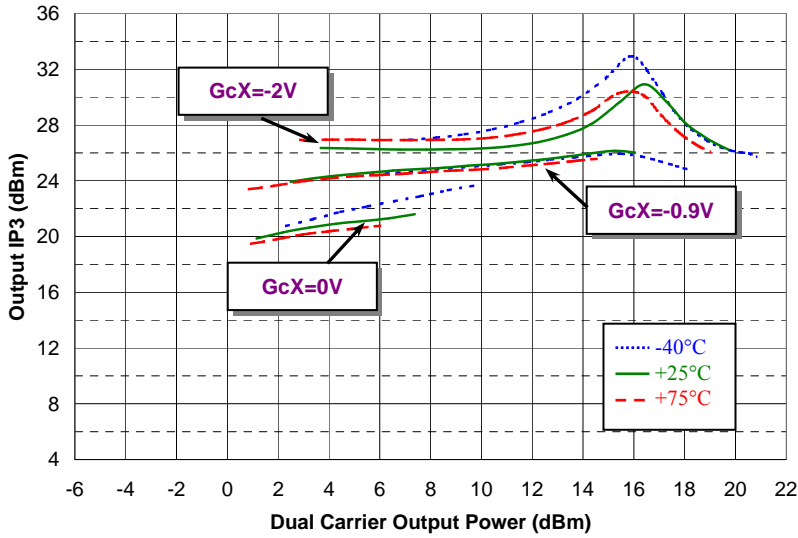

Output IP3 versus Dual Carrier Output Power and Temperature @ 21GHz

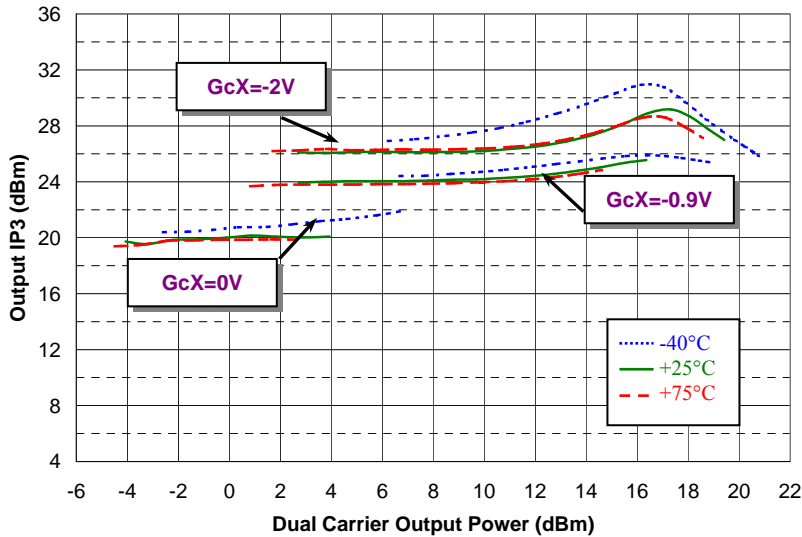

Output IP3 versus Dual Carrier Output Power and Temperature @ 27GHz

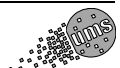
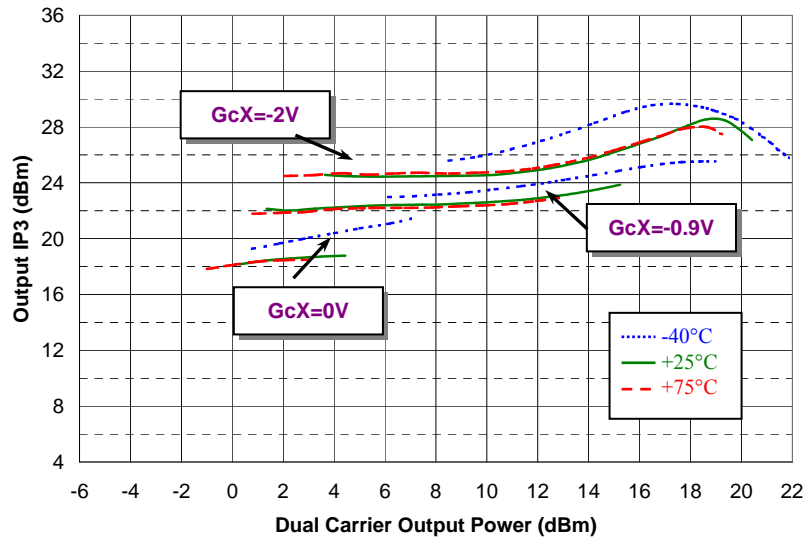

Note:

Preliminary

To decrease Noise or OIP3 variation versus gain control, it is possible to bias separately the 3 gain control voltages, Gc1, Gc2, Gc3.

- ➔ To limit Noise figure variation, keep Gc1 at -2V
- ➔ To limit OIP3 variation, keep Gc3 at -2V

Output Power at 1dB Gain Compression versus Frequency and Temperature for GcX=-2V

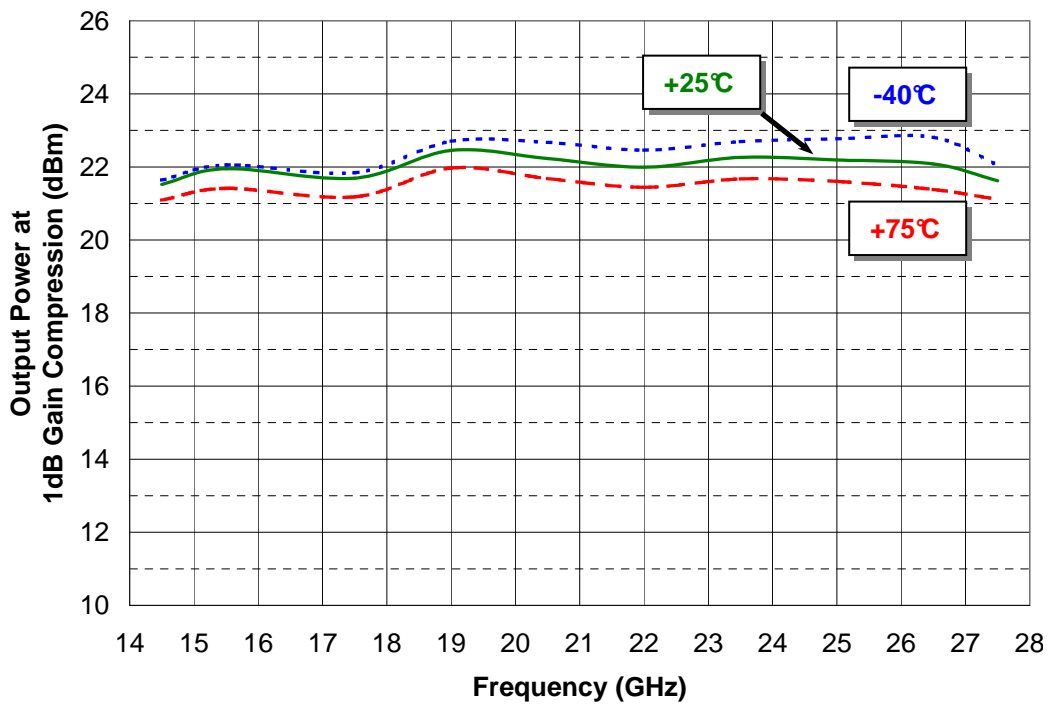

Preliminary

Gain and Output Power versus Input Power and Temperature @ 17.5GHz

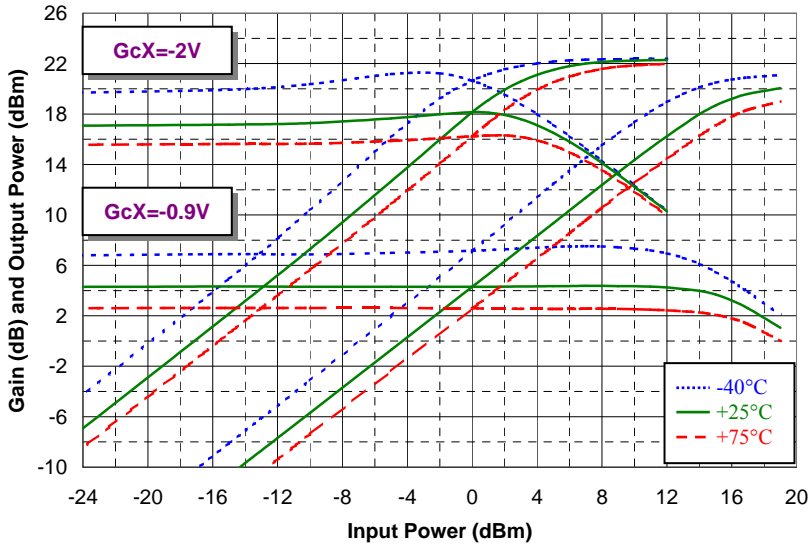

Gain and Output Power versus Input Power and Temperature @ 22GHz

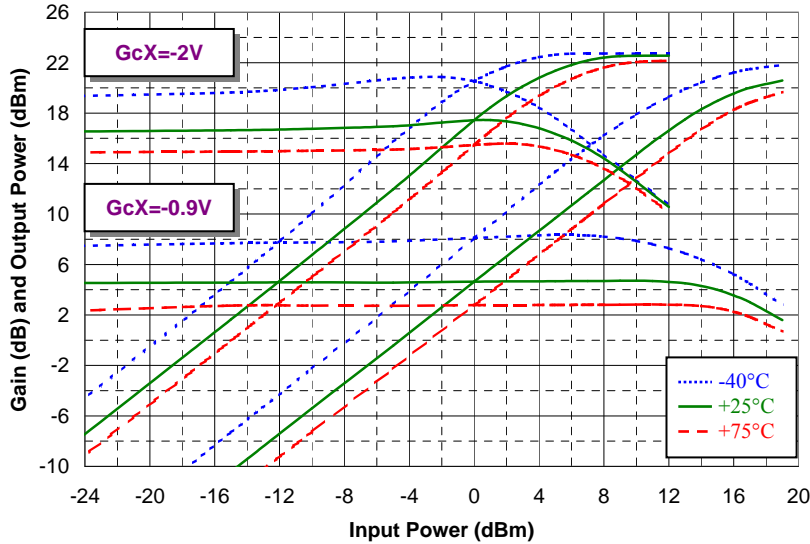

Gain and Output Power versus Input Power and Temperature @ 26.5GHz

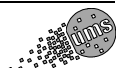
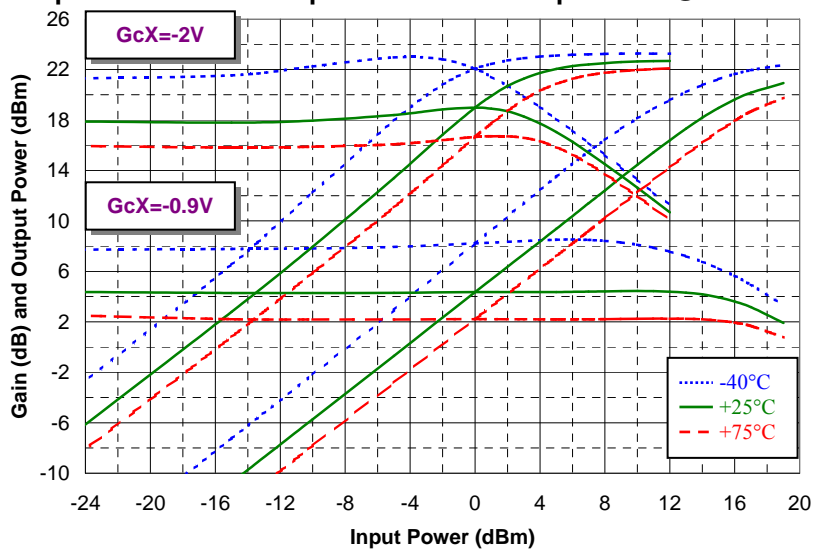

Package outline

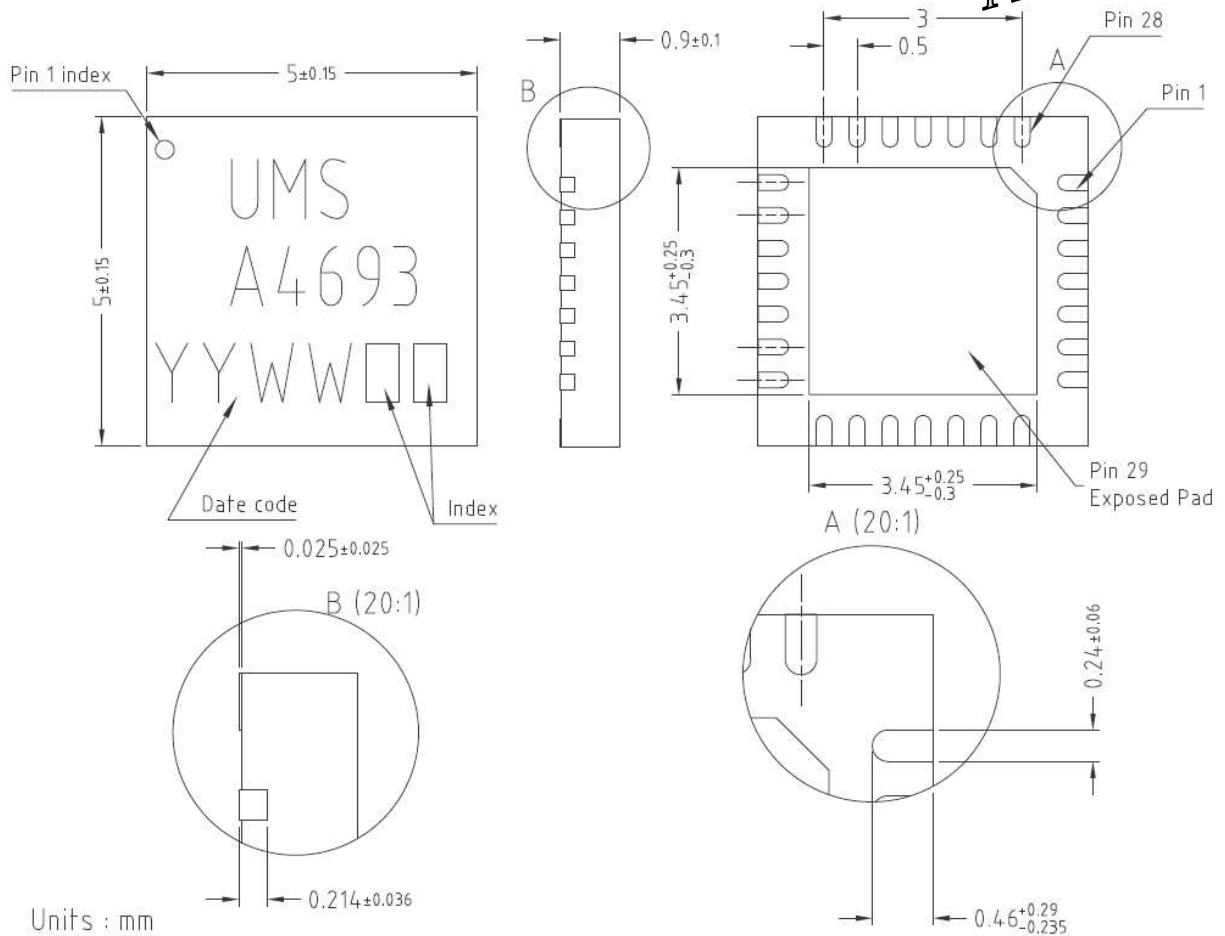

Units : mm

From the standard : JEDEC MO-220 [VHHD]

Matt tin, Lead free (Green)

1- Gnd	10- Nc	19- Gnd	28- Nc
2- RF IN	11- Nc	20- Nc	29- GND
3- Gnd	12- Vd	21- Gnd	
4- Gnd	13- Nc	22- Gnd	
5- Nc	14- Gc3	23- Nc	
6- Gnd	15- Gnd	24- Vd	
7- Gnd	16- Gnd	25- Nc	
8- Gc1	17- RF OUT	26- Vg3	
9- Gc2	18- Gnd	27- Vg1-Vg2	

It is recommended to ground the pin #22 through the PCB board.

Note

Preliminary

Due to ESD protection circuits on RF input and output, an external capacitance might be requested to isolate the product from external voltage that could be present on the RF accesses.

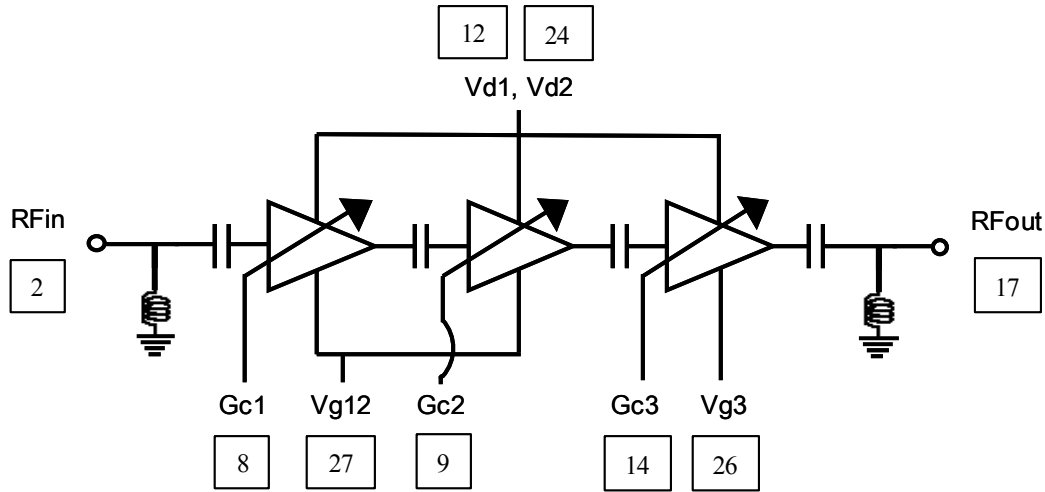

ESD protections are implemented on each gate accesses.

The DC connections do not include any decoupling capacitor in package, therefore it is mandatory to provide a good external DC decoupling on the PC board, as close as possible to the package.

Definition of the Sij reference planes

The reference planes are defined from the footprint of the recommended characterization board 97365 shown below.

The reference is the symmetrical axis of the package. The input and output reference planes are located at 3.66mm offset (input wise and output wise respectively) from this axis. Then, the given Sij incorporates this land pattern.

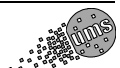
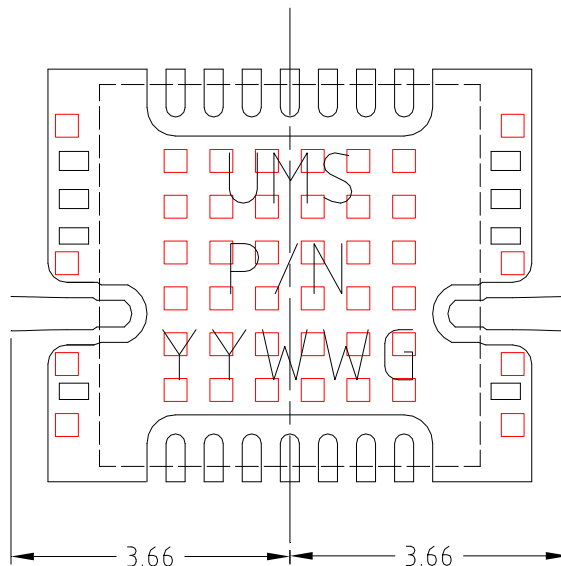

Preliminary

Recommended footprint for 28L-QFN5X5

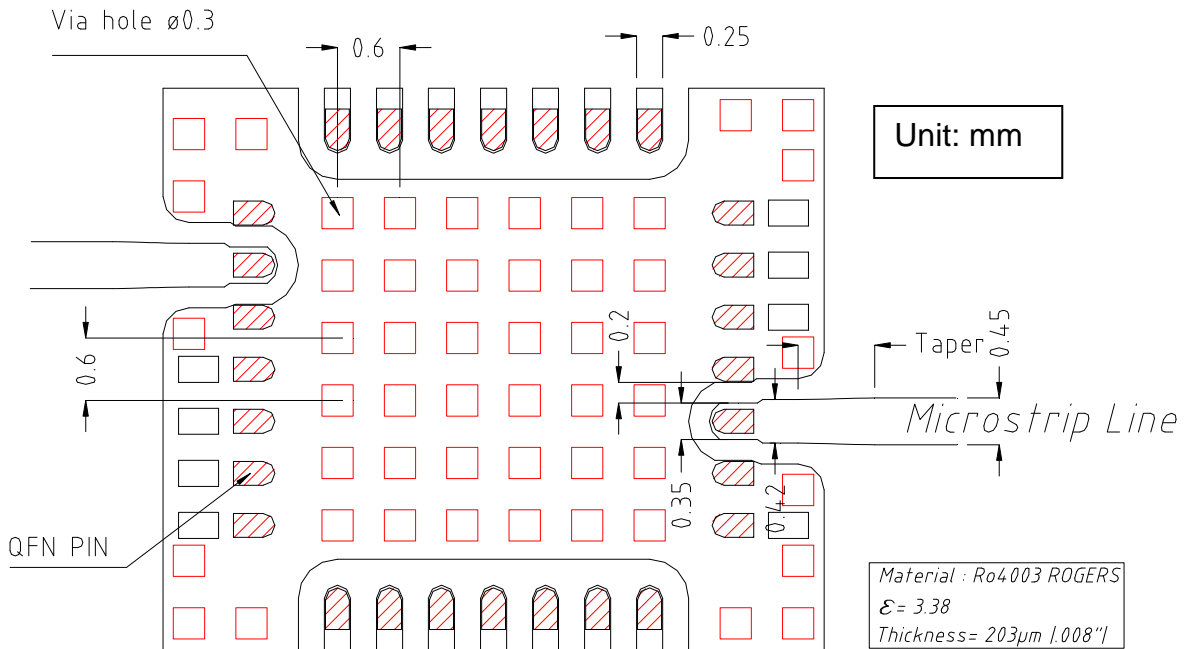

SMD mounting procedure

The SMD leadless package has been designed for high volume surface mount PCB assembly process. The dimensions and footprint required for the PCB (motherboard) are given in the drawing above.

For the mounting process standard techniques involving solder paste and a suitable reflow process can be used. For further details, see application note AN0017.

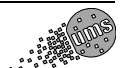

Proposed Assembly board "97365" for the 28L-QFN5x5 products characterization.

- Compatible with the proposed footprint.
- Based on typically Ro4003 / 8mils or equivalent.
- Using a microstrip to coplanar transition to access the package.
- Recommended for the implementation of this product on a module board.

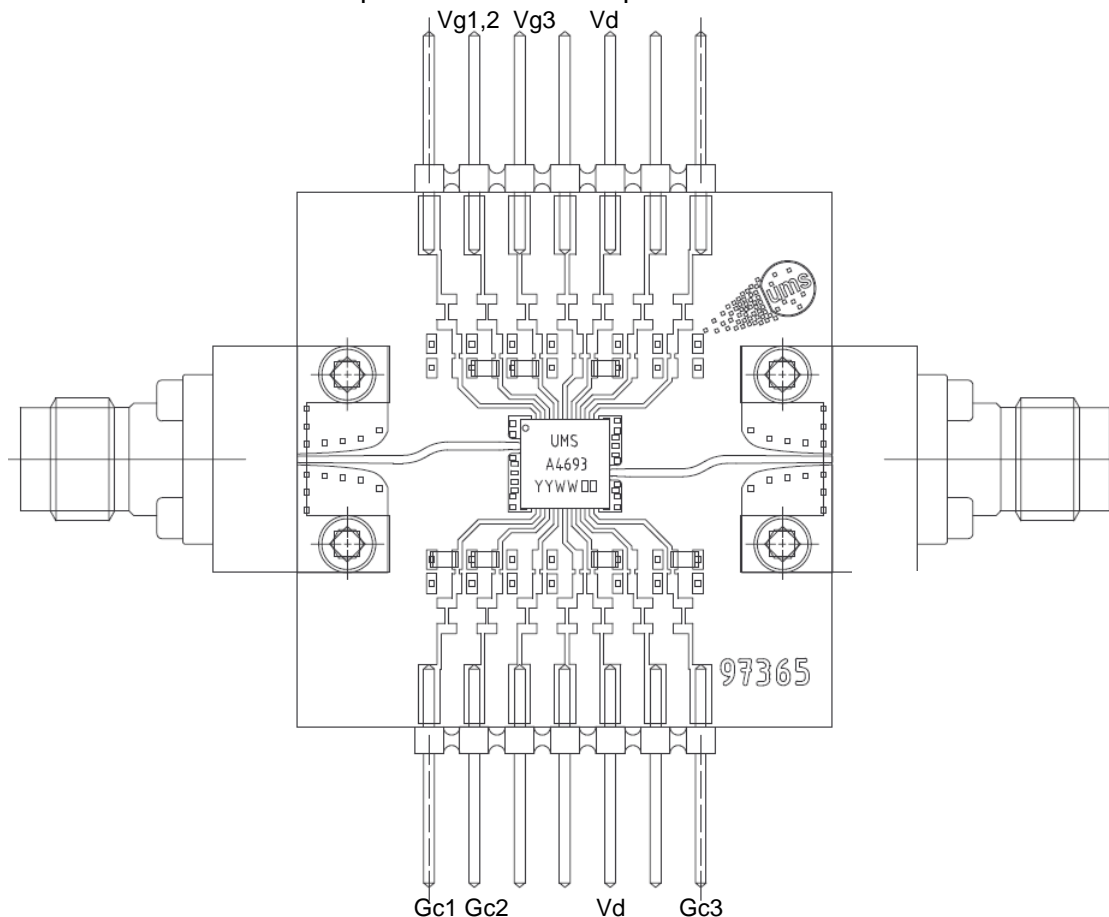

Decoupling capacitors of $10\text{nF} \pm 10\%$ are recommended for all DC accesses.

Ordering Information

QFN 5x5 RoHS compliant package: CHA4693-QGG/XY
 Stick: XY = 20 Tape & reel: XY = 21

Information furnished is believed to be accurate and reliable. However **United Monolithic Semiconductors S.A.S.** assumes no responsibility for the consequences of use of such information nor for any infringement of patents or other rights of third parties which may result from its use. No license is granted by implication or otherwise under any patent or patent rights of **United Monolithic Semiconductors S.A.S.** Specifications mentioned in this publication are subject to change without notice. This publication supersedes and replaces all information previously supplied. **United Monolithic Semiconductors S.A.S.** products are not authorised for use as critical components in life support devices or systems without express written approval from **United Monolithic Semiconductors S.A.S.**