

FDZ5013 / FDZ5013C

Frequency Doubler

Rev. V2

Features

- Input 3 to 12 GHz
- Output 6 to 24 GHz
- Input Drive Level +13 dBm (nominal)
- Hermetically-Sealed Package

Description

The FDZ5013 is a passive bridge diode frequency doubler, designed for use in military, commercial and test equipment applications. The design utilizes Schottky bridge quad diodes and broadband soft dielectric and/or ferrite baluns to attain excellent performance. The use of high temperature solder assembly processes used internally makes it ideal for use in manual and semi-automated assembly. Environmental screening available to MIL-STD-883, MIL-STD-202, or MIL-DTL-28837, consult factory.

Ordering Information

Part Number	Package
FDZ5013	Versapac
FDZ5013C	SMA Connectorized

Product Image

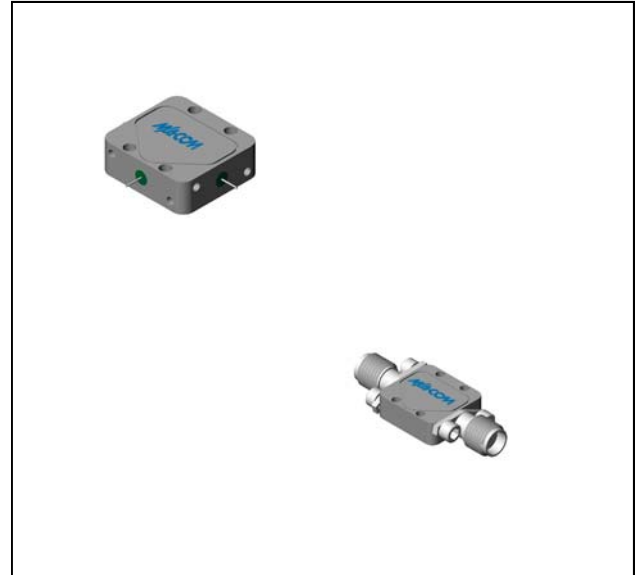

Electrical Specifications: $Z_0 = 50\Omega$ $P_{in} = +13$ dBm

Parameter	Test Conditions	Units	Typical	Guaranteed	
				+25°C	-54° to +85°C
SSB Conversion Loss (max)	$f_{in} = 3$ to 12 GHz	dB	12	14.5	15
Fundamental Suppression (min)	$f_{in} = 5$ to 8 GHz $f_{in} = 3$ to 9 GHz $f_{in} = 3$ to 12 GHz	dBc	15.0 13.0 11.0	11.0 9.5 8.0	9.0 7.5 6.0
Third Harmonic Suppression	$f_{in} = 3.0$ to 5.0 GHz $f_{in} = 5.0$ to 8.5 GHz	dBc	25 22	20 17	18 15
Input VSWR	$f_{in} = 5$ to 10 GHz $f_{in} = 3$ to 12 GHz		1.7:1 2.0:1		

Typical Performance Curves

VSWR vs. Frequency

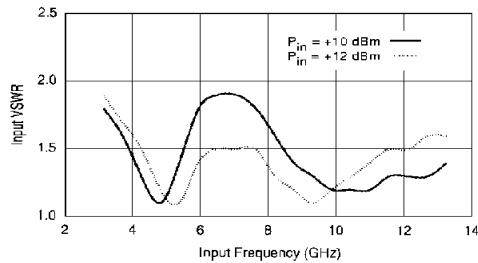

VSWR vs. Frequency

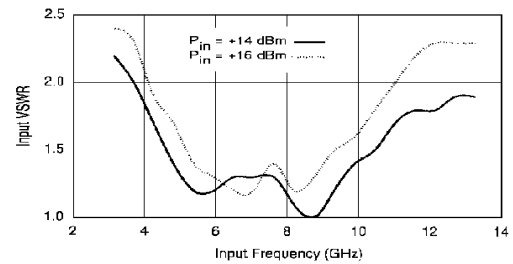

Conversion Loss vs. Frequency

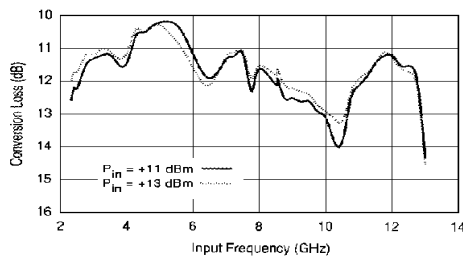

Conversion Loss vs. Frequency

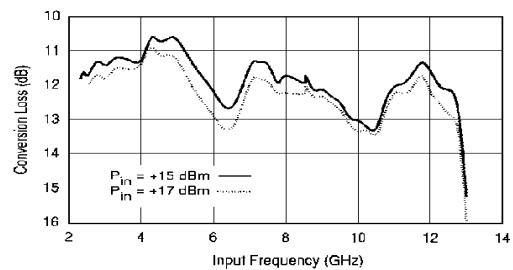

Fundamental Suppression vs. Frequency

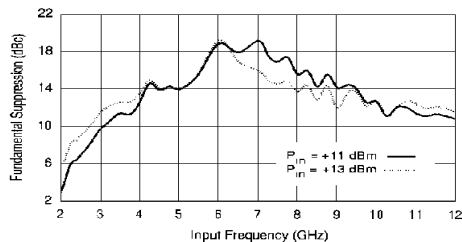

Fundamental Suppression vs. Frequency

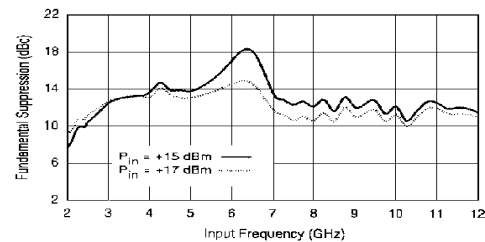

Absolute Maximum Ratings

Parameter	Absolute Maximum
Operating Temperature	-54°C to +100°C
Storage Temperature	-65°C to +100°C
Peak Input Power	+23 dBm max @ +25°C +20 dBm max @ +100°C
Peak Input Current	50 mA DC

3rd Harmonic Suppression vs. Frequency

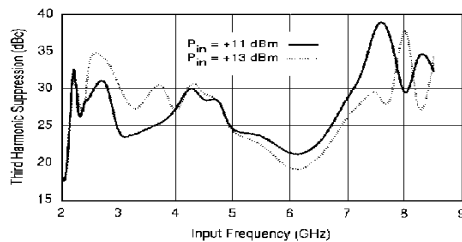

3rd Harmonic Suppression vs. Frequency

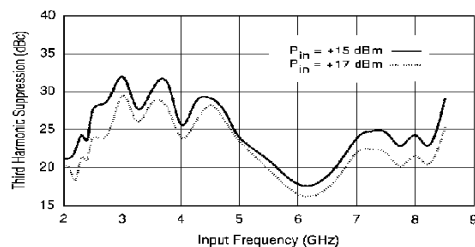

Outline Drawing: Versapac *

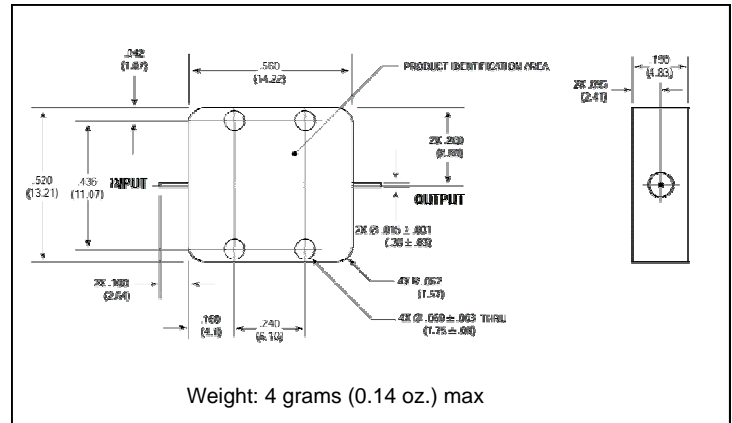

Outline Drawing: SMA Connectorized *

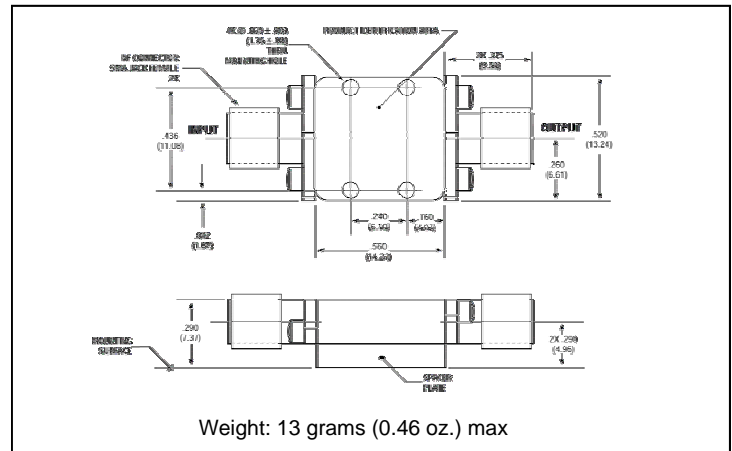

* Dimensions are inches (millimeters) ± 0.015 (0.38) unless otherwise specified.