



LIGITEK

LIGITEK ELECTRONICS CO.,LTD.  
Property of Ligitek Only

---

RECTANGLE TYPE LED LAMPS



Lead-Free Parts

**LG75240-PF**

# DATA SHEET

DOC. NO : QW0905-LG75240-PF

REV. : A

DATE : 20 - Feb. - 2006



### Package Dimensions

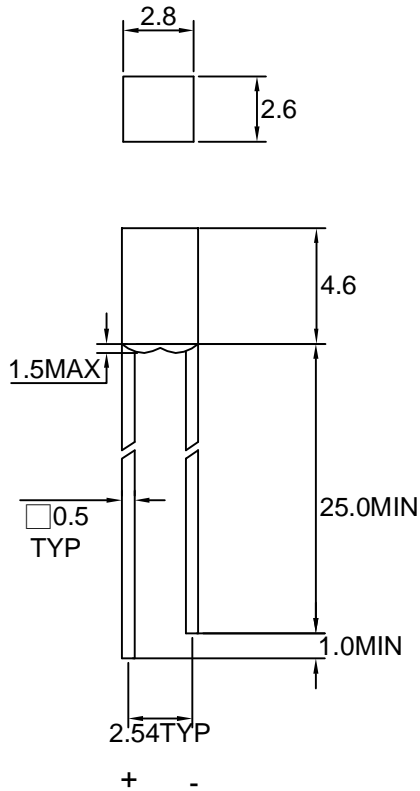

Note : 1.All dimension are in millimeter tolerance is  $\pm 0.25\text{mm}$  unless otherwise noted.  
2.Specifications are subject to change without notice.

### Directivity Radiation

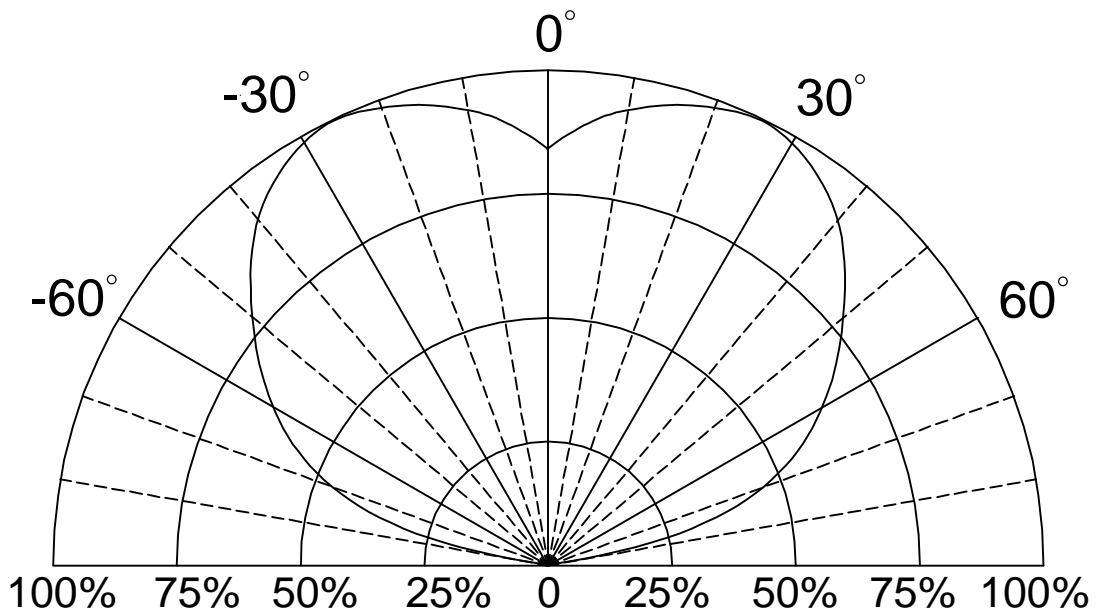

**Absolute Maximum Ratings at Ta=25 °C**

| Parameter                               | Symbol | Ratings    | UNIT |
|---|--------|------------|------|
|   |        | G          |      |
| Forward Current                         | IF     | 30         | mA   |
| Peak Forward Current<br>Duty 1/10@10KHz | IFP    | 120        | mA   |
| Power Dissipation                       | PD     | 100        | mW   |
| Reverse Current @5V                     | Ir     | 10         | μA   |
| Operating Temperature                   | Topr   | -40 ~ +85  | °C   |
| Storage Temperature                     | Tstg   | -40 ~ +100 | °C   |

**Typical Electrical & Optical Characteristics (Ta=25 °C)**

| PART NO    | MATERIAL | COLOR   |                | Peak wave length<br>λ Pnm | Spectral halfwidth<br>Δ λ nm | Forward voltage<br>@ 20mA(V) |      | Luminous intensity<br>@ 10mA(mcd) |      | Viewing angle<br>2θ 1/2<br>(deg) |
|------------|----------|---------|----------------|---------------------------|------------------------------|------------------------------|------|-----------------------------------|------|----------------------------------|
|            |          | Emitted | Lens           |                           |                              | Min.                         | Max. | Min.                              | Typ. |                                  |
| LG75240-PF | GaP      | Green   | Green Diffused | 565                       | 30                           | 1.7                          | 2.6  | 4.5                               | 12   | 138                              |

Note : 1. The forward voltage data did not including ±0.1V testing tolerance.  
2. The luminous intensity data did not including ±15% testing tolerance.



### Typical Electro-Optical Characteristics Curve

#### G CHIP

Fig.1 Forward current vs. Forward Voltage

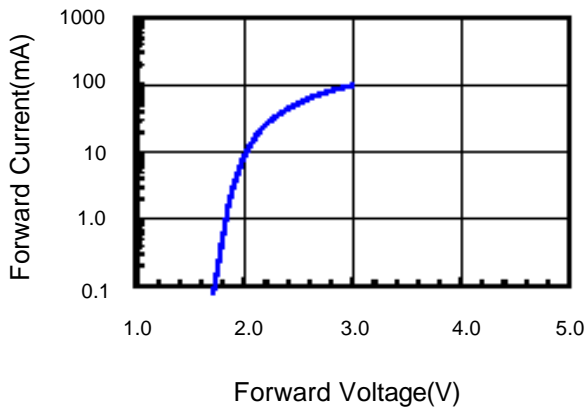

Fig.2 Relative Intensity vs. Forward Current

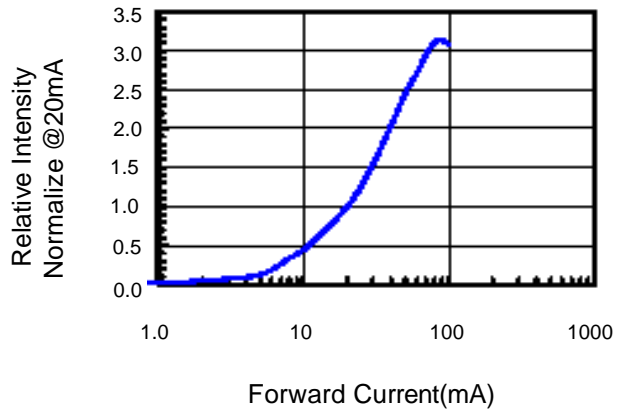

Fig.3 Forward Voltage vs. Temperature

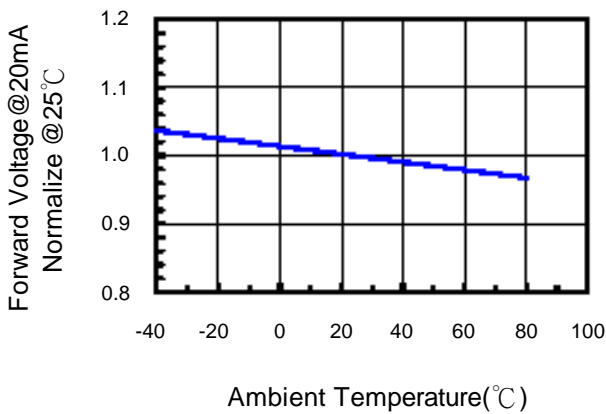

Fig.4 Relative Intensity vs. Temperature

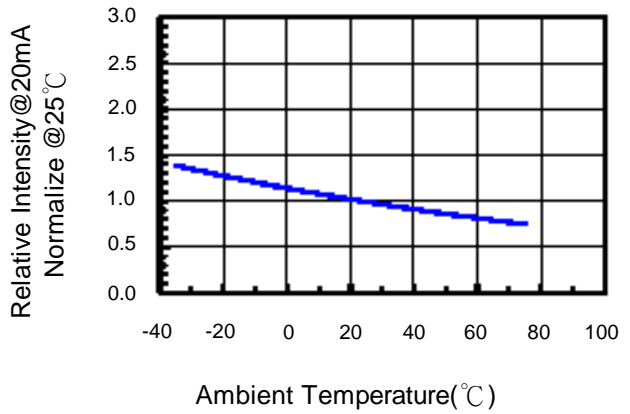

Fig.5 Relative Intensity vs. Wavelength

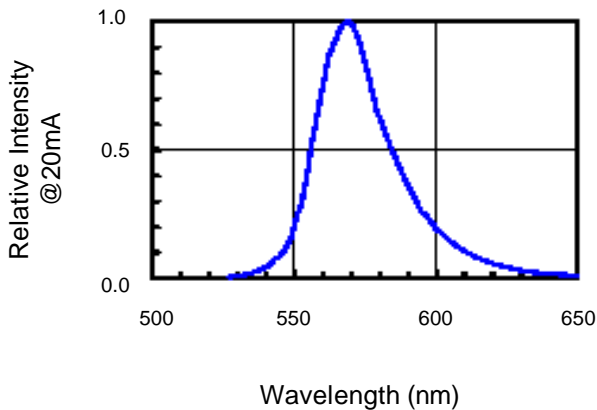

Fig.6 Directive Radiation



### Soldering Condition(Pb-Free)

#### 1.Iron:

- Soldering Iron:30W Max
- Temperature 350° C Max
- Soldering Time:3 Seconds Max(One Time)
- Distance:2mm Min(From solder joint to body)

#### 2.Wave Soldering Profile

- Dip Soldering
- Preheat: 120° C Max
- Preheat time: 60seconds Max
- Ramp-up
- 2° C/sec(max)
- Ramp-Down:-5° C/sec(max)
- Solder Bath:260° C Max
- Dipping Time:3 seconds Max
- Distance:2mm Min(From solder joint to body)

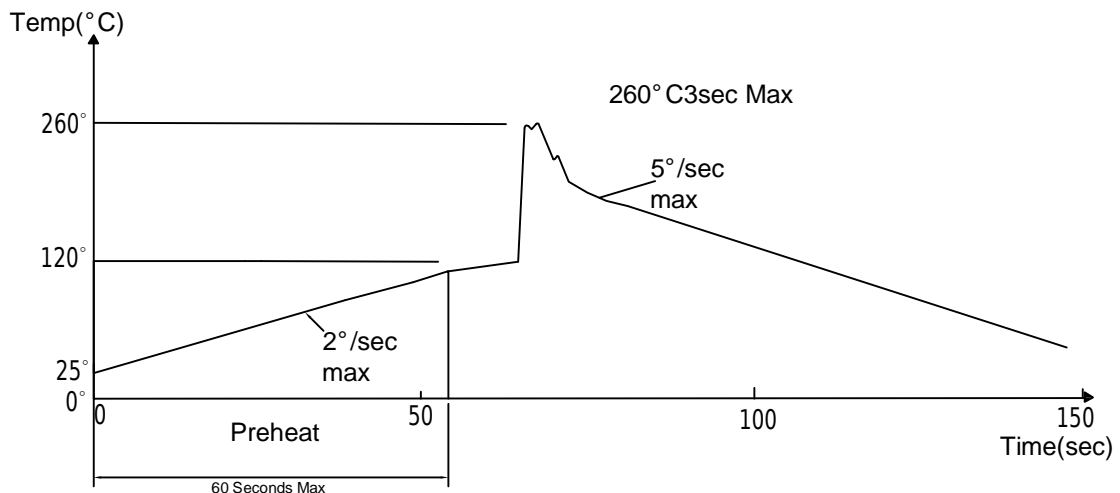

**Reliability Test:**

| Test Item                           | Test Condition   | Description   | Reference Standard   |
|-------------------------------------|--|---|--|
| Operating Life Test                 | 1.Under Room Temperature<br>2.If=20mA<br>3.t=1000 hrs (-24hrs, +72hrs) | This test is conducted for the purpose of determining the resistance of a part in electrical and thermal stressed.  | MIL-STD-750: 1026<br>MIL-STD-883: 1005<br>JIS C 7021: B-1                      |
| High Temperature Storage Test       | 1.Ta=105 °C±5°C<br>2.t=1000 hrs (-24hrs, +72hrs)                       | The purpose of this is the resistance of the device which is laid under condition of high temperature for hours.  | MIL-STD-883:1008<br>JIS C 7021: B-10   |
| Low Temperature Storage Test        | 1.Ta=-40 °C±5°C<br>2.t=1000 hrs (-24hrs, +72hrs)                       | The purpose of this is the resistance of the device which is laid under condition of low temperature for hours.   | JIS C 7021: B-12   |
| High Temperature High Humidity Test | 1.Ta=65 °C±5°C<br>2.RH=90%~95%<br>3.t=240hrs ±2hrs                     | The purpose of this test is the resistance of the device under tropical for hours.  | MIL-STD-202:103B<br>JIS C 7021: B-11   |
| Thermal Shock Test                  | 1.Ta=105 °C±5°C & -40 °C±5°C<br>(10min) (10min)<br>2.total 10 cycles   | The purpose of this is the resistance of the device to sudden extreme changes in high and low temperature.  | MIL-STD-202: 107D<br>MIL-STD-750: 1051<br>MIL-STD-883: 1011                    |
| Solder Resistance Test              | 1.T.Sol=260 °C±5°C<br>2.Dwell time= 10 ±1sec.                          | This test intended to determine the thermal characteristic resistance of the device to sudden exposures at extreme changes in temperature when soldering the lead wire. | MIL-STD-202: 210A<br>MIL-STD-750: 2031<br>JIS C 7021: A-1                      |
| Solderability Test                  | 1.T.Sol=230 °C±5°C<br>2.Dwell time=5 ±1sec                             | This test intended to see soldering well performed or not.  | MIL-STD-202: 208D<br>MIL-STD-750: 2026<br>MIL-STD-883: 2003<br>JIS C 7021: A-2 |