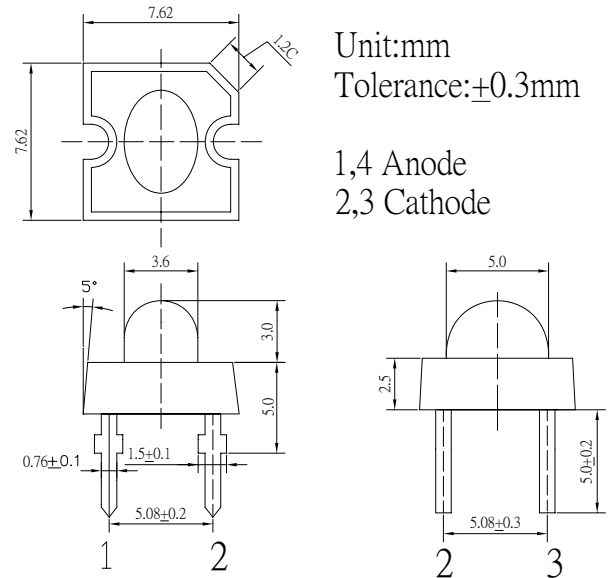

■Features

- High Luminous Super Flux Output
- 3.6x5.0mm Oval Standard Directivity
- Long Lifetime Operation
- Low Thermal Resistance
- Superior Weather-Resistance
- UV Resistant Epoxy
- Water Clear Type

■Applications

- Interior and exterior automotive lighting (e.g. dashboard backlighting etc.)
- Backlighting (Illuminated advertising, general lighting, etc)
- Decorative Lighting
- Other Lighting

■Outline Dimension

■Absolute Maximum Rating

(Ta=25°C)

Item	Symbol	Value	Unit
DC Forward Current	I_F	50	mA
Pulse Forward Current*	I_{FP}	100	mA
Reverse Voltage	V_R	5	V
Power Dissipation	P_D	180	mW
Operating Temperature	Topr	-30 ~ +85	°C
Storage Temperature	Tstg	-40 ~ +100	°C
Lead Soldering Temperature	Tsol	260°C / 5sec	-

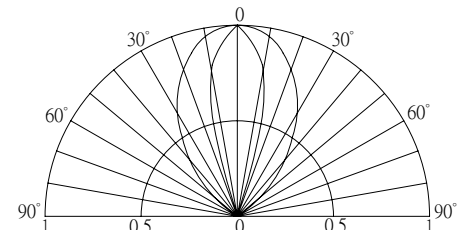
*Pulse width Max.10ms , Duty ratio max 1/10

■Directivity

■Electrical -Optical Characteristics

(Ta=25°C)

Item	Symbol	Condition	Min.	Typ.	Max.	Unit
DC Forward Voltage	V_F	$I_F=30mA$	2.9	3.1	3.6	V
DC Reverse Current	I_R	$V_R=5V$	-	-	10	μA
Luminous Intensity*	I_v	$I_F=30mA$	5800	7500	-	mcd
Chromaticity Coordinates*	x	$I_F=30mA$	-	0.45	-	
	y	$I_F=30mA$	-	0.41	-	
50% Power Angle	$2\theta_{1/2}$	$I_F=30mA$	-	30/70	-	deg

*1 Tolerance of chromaticity coordinate is ±10%

*2 Tolerance of luminous intensity is ±15%