

Surface Mount Zener Diode

MMSZ52XXBS Series

A suffix of "-C" specifies halogen-free

200mW, SOD-323

Electrical Characteristics @ $T_A=25^\circ\text{C}$ unless otherwise specified

Type Number	Marking Code		Zener Voltage Range (Note 1)				Maximum Zener Impedance (Note 3)		Maximum Reverse Leakage Current (Note 1)	
			$V_Z @ I_{ZT}$			I_{ZT}	$Z_{ZT}@I_{ZT}$	$V_{ZK} @ I_{ZK} = 0.25\text{mA}$	$I_R @ V_R$	
			Nom	Min	Max				μA	V
			V	V	V	mA	Ω			
MMSZ5221BS	C1	1A	2.4	2.28	2.52	20	30	1200	100	1.0
MMSZ5222BS	C2	1B	2.5	2.38	2.63	20	30	1250	100	1.0
MMSZ5223BS	C3	1C	2.7	2.57	2.84	20	30	1300	75	1.0
MMSZ5225BS	C5	1E	3.0	2.85	3.15	20	30	1600	50	1.0
MMSZ5226BS	D1	8A	3.3	3.14	3.47	20	28	1600	25	1.0
MMSZ5227BS	D2	8B	3.6	3.42	3.78	20	24	1700	15	1.0
MMSZ5228BS	D3	8C	3.9	3.71	4.10	20	23	1900	10	1.0
MMSZ5229BS	D4	8D	4.3	4.09	4.52	20	22	2000	5.0	1.0
MMSZ5230BS	D5	8E	4.7	4.47	4.94	20	19	1900	5.0	2.0
MMSZ5231BS	E1	8F	5.1	4.85	5.36	20	17	1600	5.0	2.0
MMSZ5232BS	E2	8G	5.6	5.32	5.88	20	11	1600	5.0	3.0
MMSZ5233BS	E3	8H	6.0	5.70	6.30	20	7	1600	5.0	3.5
MMSZ5234BS	E4	8J	6.2	5.89	6.51	20	7	1000	5.0	4.0
MMSZ5235BS	E5	8K	6.8	6.46	7.14	20	5	750	3.0	5.0
MMSZ5236BS	F1	8L	7.5	7.13	7.88	20	6	500	3.0	6.0
MMSZ5237BS	F2	8M	8.2	7.79	8.61	20	8	500	3.0	6.5
MMSZ5238BS	F3	8N	8.7	8.27	9.14	20	8	600	3.0	6.5
MMSZ5239BS	F4	8P	9.1	8.65	9.56	20	10	600	3.0	7.0
MMSZ5240BS	F5	8Q	10	9.50	10.50	20	17	600	3.0	8.0
MMSZ5241BS	H1	8R	11	10.45	11.55	20	22	600	2.0	8.4
MMSZ5242BS	H2	8S	12	11.40	12.60	20	30	600	1.0	9.1
MMSZ5243BS	H3	8T	13	12.35	13.65	9.5	13	600	0.5	9.9
MMSZ5245BS	H5	8V	15	14.25	15.75	8.5	16	600	0.1	11
MMSZ5246BS	J1	8W	16	15.20	16.80	7.8	17	600	0.1	12
MMSZ5248BS	J3	8Y	18	17.10	18.90	7.0	21	600	0.1	14
MMSZ5250BS	J5	2A	20	19.00	21.00	6.2	25	600	0.1	15
MMSZ5251BS	K1	2B	22	20.90	23.10	5.6	29	600	0.1	17
MMSZ5252BS	K2	2C	24	22.80	25.20	5.2	33	600	0.1	18
MMSZ5254BS	K4	2E	27	25.65	28.35	5.0	41	600	0.1	21
MMSZ5255BS	K5	2F	28	26.60	29.40	4.5	44	600	0.1	21
MMSZ5256BS	M1	2G	30	28.50	31.50	4.2	49	600	0.1	23
MMSZ5257BS	M2	2H	33	31.35	34.65	3.8	58	700	0.1	25
MMSZ5258BS	M3	2J	36	34.20	37.80	3.4	70	700	0.1	27
MMSZ5259BS	M4	2K	39	37.05	40.95	3.2	80	800	0.1	30

Notes:

1. Short duration test pulse used to minimize self-heating effect.
2. Device mount on ceramic PCB; 7.6 mm x 9.4 mm x 0.87 mm with pad areas 25 mm².
3. f = 1 kHz

• Maximum Ratings @ $T_A=25^\circ\text{C}$ unless otherwise specified

Characteristic	Symbol	Value	Unit
Forward Voltage (Note 1) @ $I_F = 10\text{ mA}$	V_F	1.0	V
Power Dissipation (Note 2)	P_d	200	mW
Thermal Resistance, Junction to Ambient Air (Note 2)	$R_{\theta JA}$	650	$^\circ\text{C} / \text{W}$
Operating and Storage Temperature Range	T_J, T_{STG}	-65 ~ +150	$^\circ\text{C}$

Notes:

1. Short duration test pulse used in minimizes self-heating effect.
2. Device mount on ceramic PCB; 7.6 mm x 9.4 mm x 0.87 mm with pad areas 25 mm².

Features

- RoHS Compliant
- Planar Die Construction
- General Purpose Dissipation
- Ideally suited for Automated Assembly Process

Mechanical Data

- Case: SOD-323, Plastic
- Case material – UL Flammability Rating Classification 94V-0
- Moisture sensitivity: Level 1 per J-STD-020A
- Terminals: Solderable per MIL-STD-202, Method 208
- Polarity: Cathode Band
- Weight: 0.005 grams (approx.)

Outline

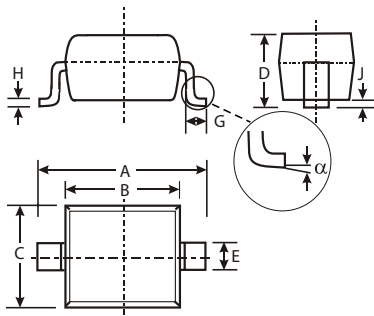

SOD-323		
Dim	Min	Max
A	2.30	2.70
B	1.95	1.75
C	1.15	1.35
D	-	0.95
E	0.31 Typical	
G	0.15	-
H	0.11 Typical	
J	-	0.10
α	0°	8°
All Dimensions in mm		

● Electrical Characteristic Curves @ TA=25°C

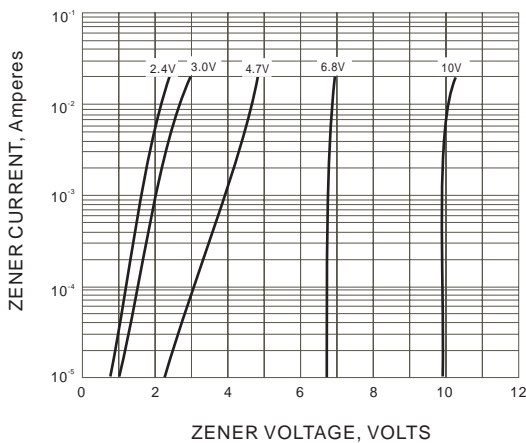

Fig.1 ZENER VOLTAGE VERSUS ZENER CURRENT

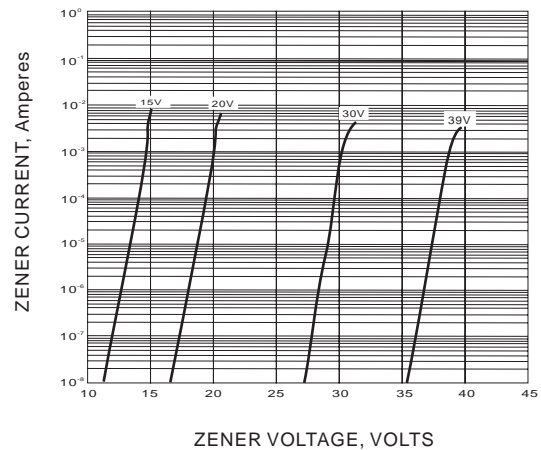

Fig.2 ZENER VOLTAGE VERSUS ZENER CURRENT

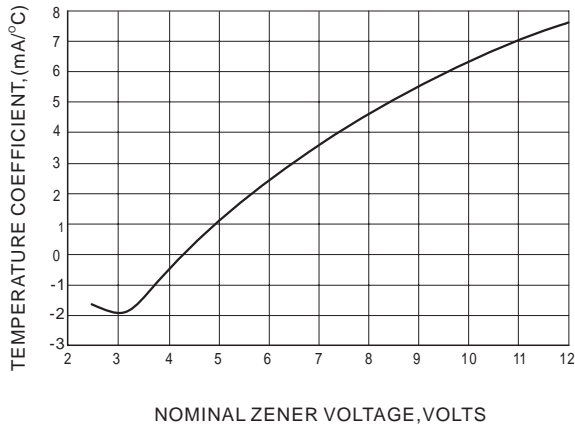

Fig.3 TEMPERATURE COEFFICIENTS

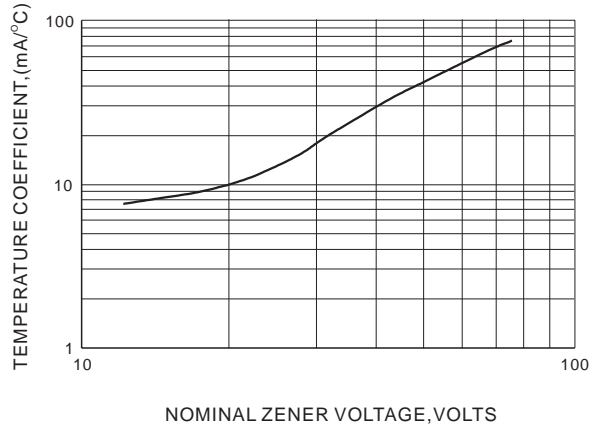

Fig.4 TEMPERATURE COEFFICIENTS

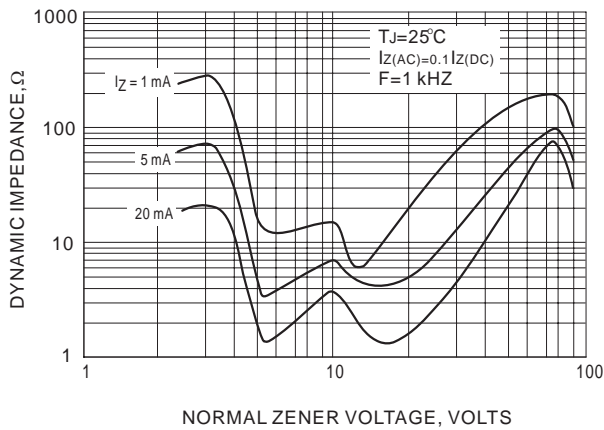

Fig.5 EFFECT OF ZENER VOLTAGE ON ZENER IMPEDANCE

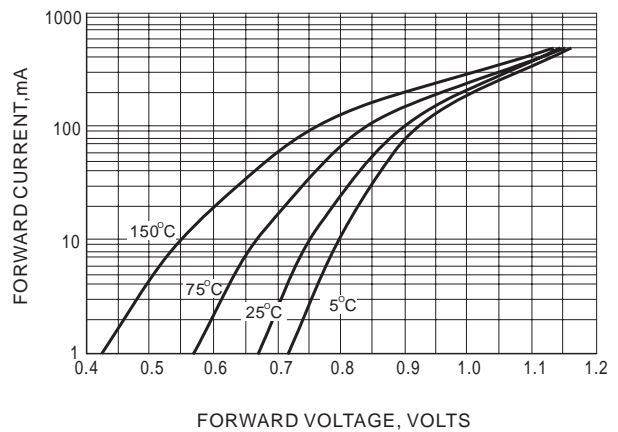

Fig.6 TYPICAL FORWARD VOLTAGE

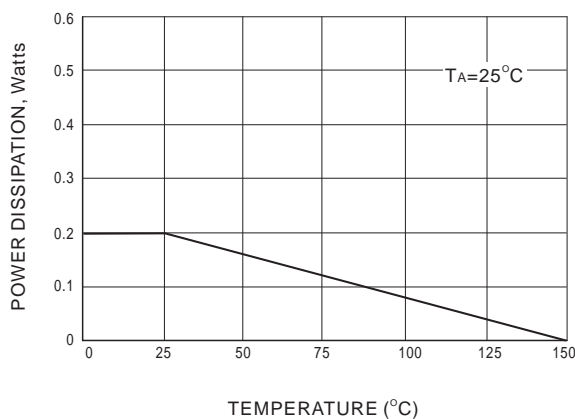

Fig.7 STEADY STATE POWER DERATING

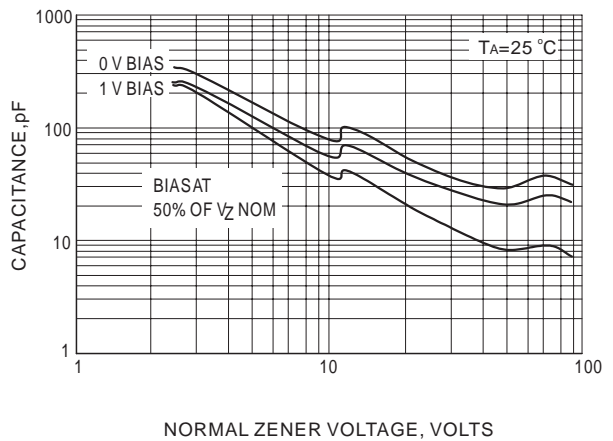

Fig.7 TYPICAL CAPACITANCE