

3 Volt Voltage Variable Attenuator 25 dB, DC - 2.5 GHz

Rev. V1

Features

- Single Voltage Control: 0 to -3 Volts
- 25 dB Attenuation Range at 0.9 GHz
- Low DC Power Consumption
- Lead-Free SOT-25 Package
- 100% Matte Tin Plating over Copper
- Halogen-Free "Green" Mold Compound
- 260°C Reflow Compatible
- RoHS* Compliant Version of AT-255

Description

M/A-COM's MAAVSS0006 is a GaAs MMIC voltage variable absorptive attenuator in a lead-free SOT-25 surface mount plastic package. The MAAVSS0005 is ideally suited for use where variable attenuation, fine tuning, and very low power consumption are required.

Typical applications include radio, cellular, GPS equipment and automatic gain/level control circuits.

The MAAVSS0006 is fabricated using a mature 1-micron GaAs MESFET process. The process features full chip passivation for increased performance and reliability.

Ordering Information ^{1,2}

Part Number	Package
MAAVSS0006	Bulk Packaging
MAAVSS0006TR-3000	3000 piece reel
MAAVSS0006SMB	Sample Board

1. Reference Application Note M513 for reel size information.
2. All sample boards include 5 loose parts.

Functional Schematic ³

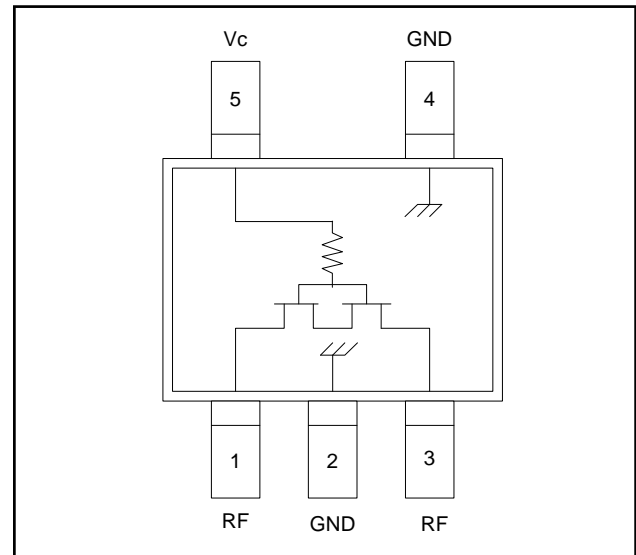

3. $V_C = -3\text{ V to } 0\text{ V @ } 25\text{ }\mu\text{A maximum.}$

Pin Configuration

Pin No.	Function	Pin No.	Function
1	RF Port	4	Ground
2	Ground	5	V_C
3	RF Port		

Absolute Maximum Ratings ^{4,5}

Parameter	Absolute Maximum
Input Power	+21 dBm
Control Voltage V_C	$-8\text{ V} \leq V_C \leq +0.5\text{ V}$
Operating Temperature	$-40^\circ\text{C to } +85^\circ\text{C}$
Storage Temperature	$-65^\circ\text{C to } +150^\circ\text{C}$

4. Exceeding any one or combination of these limits may cause permanent damage to this device.
5. M/A-COM does not recommend sustained operation near these survivability limits.

* Restrictions on Hazardous Substances, European Directive 2002/95/EC.

3 Volt Voltage Variable Attenuator 25 dB, DC - 2.5 GHz

Rev. V1

Electrical Specifications: $T_A = 25^\circ\text{C}$, $Z_0 = 50 \Omega$

Parameter	Test Conditions	Units	Min	Typ	Max
Insertion Loss ⁵	DC - 2.0 GHz	dB	—	3.6	4.2
Attenuation	DC - 1.0 GHz	dB	23	25	—
	1.0 - 2.0 GHz	dB	18	20	—
Flatness (Peak-to-Peak)	0.5 - 1.0 GHz	dB	—	± 7	± 10
	1.0 - 2.0 GHz	dB	—	± 5	± 8
VSWR	DC - 2.0 GHz	Ratio	—	3:1	—
Trise, Tfall	10% to 90% RF, 90% to 10% RF	nS	—	10	—
Ton, Toff	50% Control to 90% RF, 50% Control to 10% RF	nS	—	20	—
Transients	In Band	mV	—	10	—

5. Insertion loss varies 0.003 dB/°C.

Lead-Free SOT-25[†]

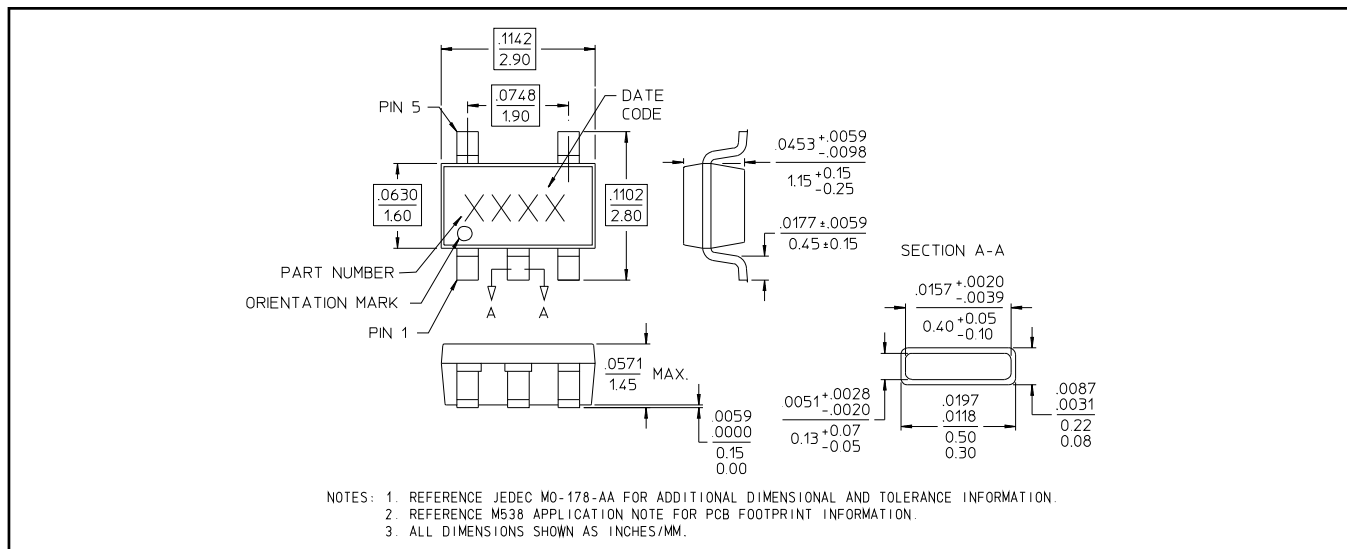

[†] Reference Application Note M538 for lead-free solder reflow recommendations.
Meets JEDEC moisture sensitivity level 1 requirements.

Handling Procedures

Please observe the following precautions to avoid damage:

Static Sensitivity

Gallium Arsenide Integrated Circuits are sensitive to electrostatic discharge (ESD) and can be damaged by static electricity. Proper ESD control techniques should be used when handling these devices.

Typical Performance Curves

Relative Attenuation vs. Control Voltage

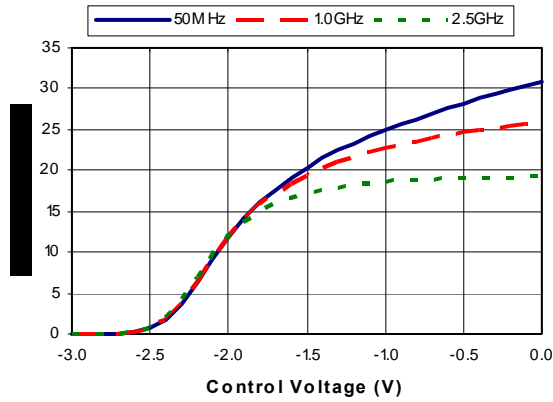

Insertion Loss vs. Frequency

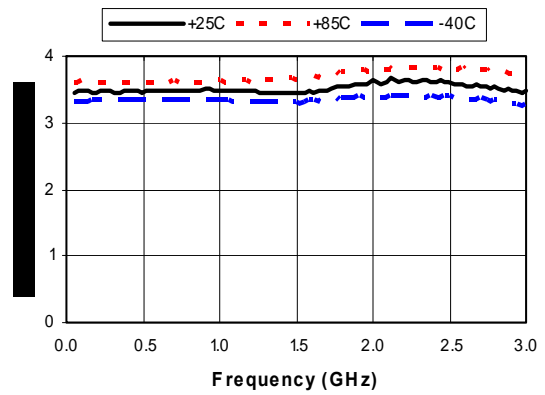

Maximum Relative Attenuation vs. Frequency

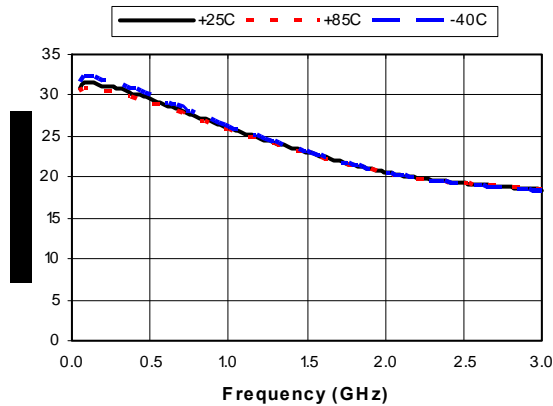

Return Loss vs. Control Voltage @ 900 MHz

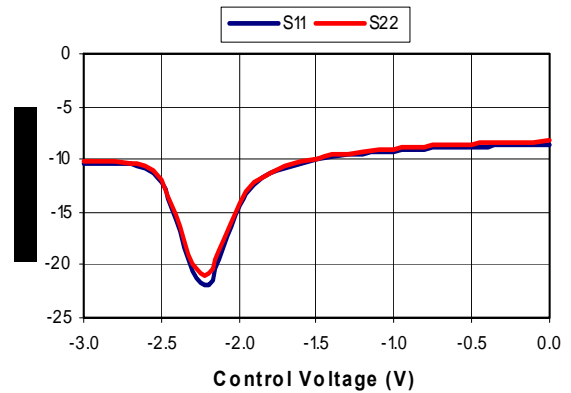

Input IP3 vs. Control Voltage

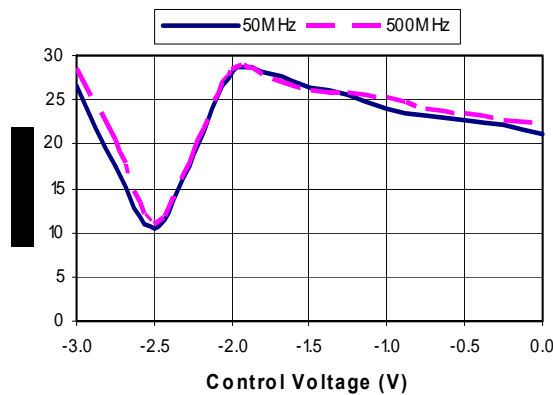

Input P1dB vs. Control Voltage

