

## Dual Boost chopper NPT IGBT Power Module

$V_{CES} = 1200V$   
 $I_C = 50A @ T_c = 80^\circ C$

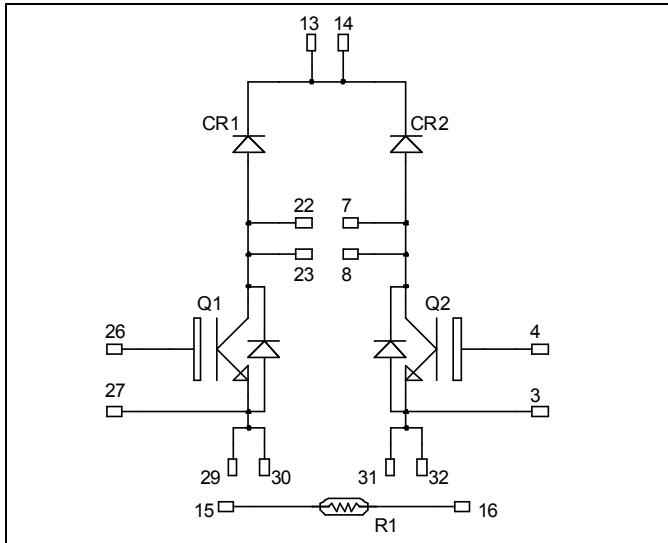

### Application

- AC and DC motor control
- Switched Mode Power Supplies

### Features

- Non Punch Through (NPT) Fast IGBT
  - Low voltage drop
  - Low tail current
  - Switching frequency up to 50 kHz
  - Soft recovery parallel diodes
  - Low diode VF
  - Low leakage current
  - RBSOA and SCSOA rated
  - Symmetrical design
- Kelvin emitter for easy drive
- Very low stray inductance
- High level of integration
- Internal thermistor for temperature monitoring

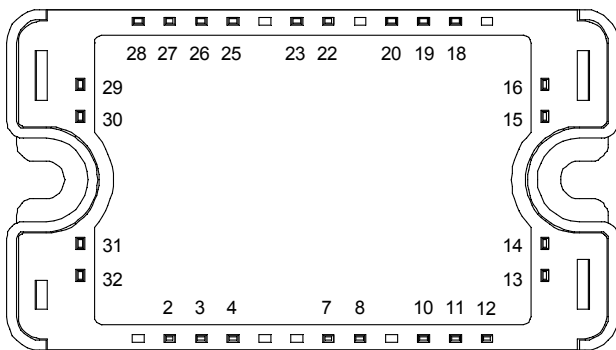

### Benefits

- Outstanding performance at high frequency operation
- Direct mounting to heatsink (isolated package)
- Low junction to case thermal resistance
- Solderable terminals both for power and signal for easy PCB mounting
- Low profile
- Easy paralleling due to positive TC of VCEsat
- Each leg can be easily paralleled to achieve a single buck of twice the current capability
- RoHS compliant

All multiple inputs and outputs must be shorted together  
 Example: 13/14 ; 29/30 ; 22/23 ...

### Absolute maximum ratings

Symbol	Parameter	Max ratings	Unit
$V_{CES}$	Collector - Emitter Breakdown Voltage	1200	V
$I_C$	Continuous Collector Current	$T_c = 25^\circ C$	70
		$T_c = 80^\circ C$	50
$I_{CM}$	Pulsed Collector Current	$T_c = 25^\circ C$	150
$V_{GE}$	Gate - Emitter Voltage	$\pm 20$	V
$P_D$	Maximum Power Dissipation	$T_c = 25^\circ C$	312
RBSOA	Reverse Bias Safe Operating Area	$T_j = 150^\circ C$	100A @ 1200V

**CAUTION:** These Devices are sensitive to Electrostatic Discharge. Proper Handling Procedures Should Be Followed. See application note APT0502 on [www.microsemi.com](http://www.microsemi.com)

All ratings @  $T_j = 25^\circ\text{C}$  unless otherwise specified

**Electrical Characteristics**

Symbol	Characteristic	Test Conditions	Min	Typ	Max	Unit
$I_{CES}$	Zero Gate Voltage Collector Current	$V_{GE} = 0\text{V}$ $V_{CE} = 1200\text{V}$	$T_j = 25^\circ\text{C}$		250	$\mu\text{A}$
			$T_j = 125^\circ\text{C}$		500	
$V_{CE(sat)}$	Collector Emitter saturation Voltage	$V_{GE} = 15\text{V}$ $I_C = 50\text{A}$	$T_j = 25^\circ\text{C}$	3.2	3.7	V
			$T_j = 125^\circ\text{C}$	4.0		
$V_{GE(th)}$	Gate Threshold Voltage	$V_{GE} = V_{CE2}$ , $I_C = 1\text{ mA}$	4.5		6.5	V
$I_{GES}$	Gate – Emitter Leakage Current	$V_{GE} = 20\text{ V}$ , $V_{CE} = 0\text{V}$			100	nA

**Dynamic Characteristics**

Symbol	Characteristic	Test Conditions	Min	Typ	Max	Unit
$C_{ies}$	Input Capacitance	$V_{GE} = 0\text{V}$ $V_{CE} = 25\text{V}$ $f = 1\text{MHz}$		3450		pF
$C_{oes}$	Output Capacitance			330		
$C_{res}$	Reverse Transfer Capacitance			220		
$Q_g$	Total gate Charge	$V_{GS} = 15\text{V}$ $V_{Bus} = 600\text{V}$ $I_C = 50\text{A}$		330		nC
$Q_{ge}$	Gate – Emitter Charge			35		
$Q_{gc}$	Gate – Collector Charge			200		
$T_{d(on)}$	Turn-on Delay Time	Inductive Switching ( $25^\circ\text{C}$ ) $V_{GE} = 15\text{V}$ $V_{Bus} = 600\text{V}$ $I_C = 50\text{A}$ $R_G = 5\ \Omega$		35		ns
$T_r$	Rise Time			65		
$T_{d(off)}$	Turn-off Delay Time			320		
$T_f$	Fall Time			30		
$T_{d(on)}$	Turn-on Delay Time	Inductive Switching ( $125^\circ\text{C}$ ) $V_{GE} = \pm 15\text{V}$ $V_{Bus} = 600\text{V}$ $I_C = 50\text{A}$ $R_G = 5\ \Omega$		35		ns
$T_r$	Rise Time			65		
$T_{d(off)}$	Turn-off Delay Time			360		
$T_f$	Fall Time			40		
$E_{on}$	Turn-on Switching Energy	$V_{GE} = \pm 15\text{V}$ $V_{Bus} = 600\text{V}$ $I_C = 50\text{A}$ $R_G = 5\ \Omega$	$T_j = 125^\circ\text{C}$		6.9	mJ
$E_{off}$	Turn-off Switching Energy				3.05	
$I_{sc}$	Short Circuit data	$V_{GE} \leq 15\text{V}$ ; $V_{Bus} = 900\text{V}$ $t_p \leq 10\ \mu\text{s}$ ; $T_j = 125^\circ\text{C}$		300		A

**Chopper diode ratings and characteristics**

Symbol	Characteristic	Test Conditions	Min	Typ	Max	Unit
$V_{RRM}$	Maximum Peak Repetitive Reverse Voltage		1200			V
$I_{RM}$	Maximum Reverse Leakage Current	$V_R = 1200\text{V}$	$T_j = 25^\circ\text{C}$		100	$\mu\text{A}$
			$T_j = 125^\circ\text{C}$		500	
$I_F$	DC Forward Current	$T_c = 80^\circ\text{C}$		60		A
$V_F$	Diode Forward Voltage	$I_F = 60\text{A}$		2.5	3	V
		$I_F = 120\text{A}$		3		
		$I_F = 60\text{A}$	$T_j = 125^\circ\text{C}$	1.8		
$t_{rr}$	Reverse Recovery Time	$I_F = 60\text{A}$ $V_R = 800\text{V}$ $di/dt = 200\text{A}/\mu\text{s}$	$T_j = 25^\circ\text{C}$	265		ns
			$T_j = 125^\circ\text{C}$	350		
$Q_{rr}$	Reverse Recovery Charge	$I_F = 60\text{A}$ $V_R = 800\text{V}$ $di/dt = 200\text{A}/\mu\text{s}$	$T_j = 25^\circ\text{C}$	560		nC
			$T_j = 125^\circ\text{C}$	2890		

## Thermal and package characteristics

Symbol	Characteristic	Min	Typ	Max	Unit	
R <sub>thJC</sub>	Junction to Case Thermal Resistance	IGBT		0.4	°C/W	
		Diode		0.9		
V <sub>ISOL</sub>	RMS Isolation Voltage, any terminal to case t=1 min, I <sub>isol</sub> <1mA, 50/60Hz	2500			V	
T <sub>J</sub>	Operating junction temperature range	-40		150	°C	
T <sub>STG</sub>	Storage Temperature Range	-40		125		
T <sub>C</sub>	Operating Case Temperature	-40		100		
Torque	Mounting torque	To heatsink	M4	2.5	4.7	N.m
Wt	Package Weight				110	g

## Temperature sensor NTC (see application note APT0406 on www.microsemi.com for more information).

Symbol	Characteristic	Min	Typ	Max	Unit
R <sub>25</sub>	Resistance @ 25°C		50		kΩ
ΔR <sub>25</sub> /R <sub>25</sub>			5		%
B <sub>25/85</sub>	T <sub>25</sub> = 298.15 K		3952		K
ΔB/B	T <sub>C</sub> = 100°C		4		%

$$R_T = \frac{R_{25}}{\exp\left[B_{25/85}\left(\frac{1}{T_{25}} - \frac{1}{T}\right)\right]}$$

T: Thermistor temperature  
 R<sub>T</sub>: Thermistor value at T

## SP3 Package outline (dimensions in mm)

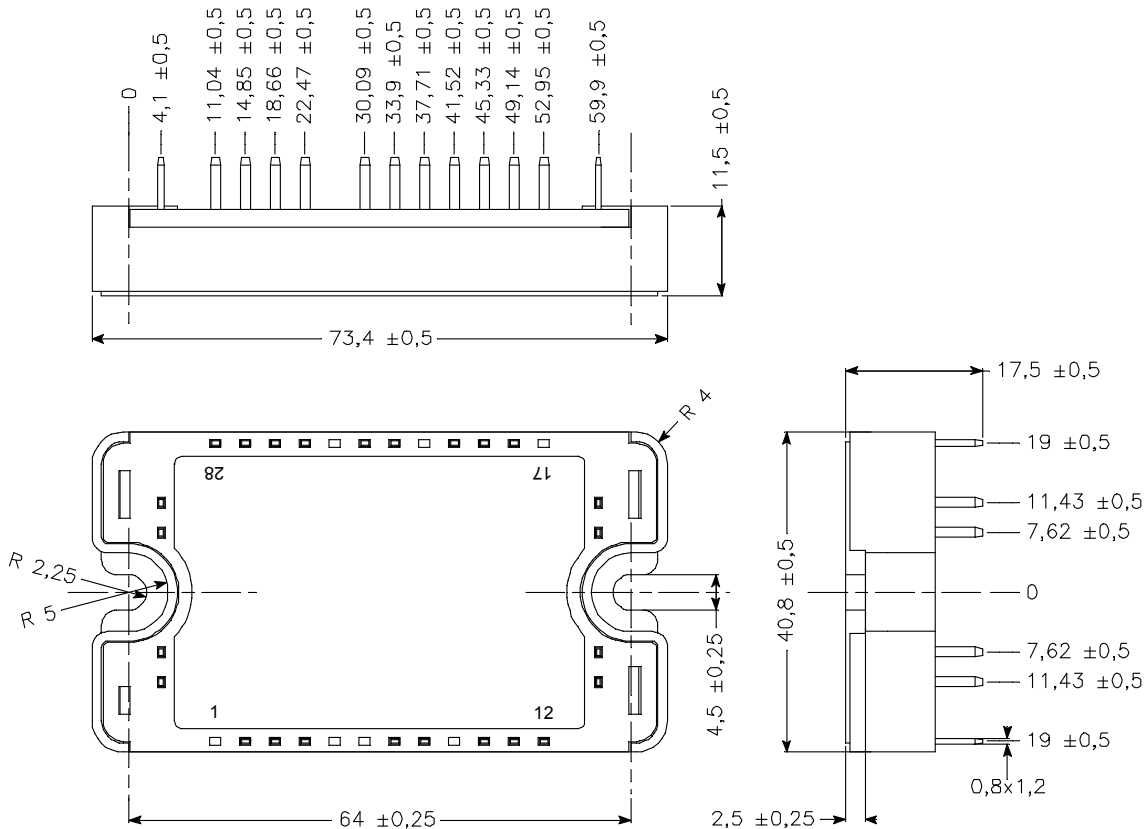

See application note 1901 - Mounting Instructions for SP3 Power Modules on [www.microsemi.com](http://www.microsemi.com)

## Typical IGBT Performance Curve

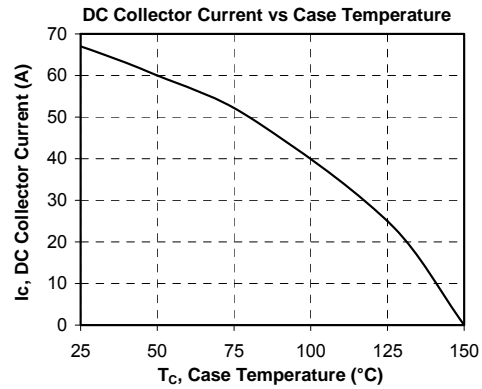
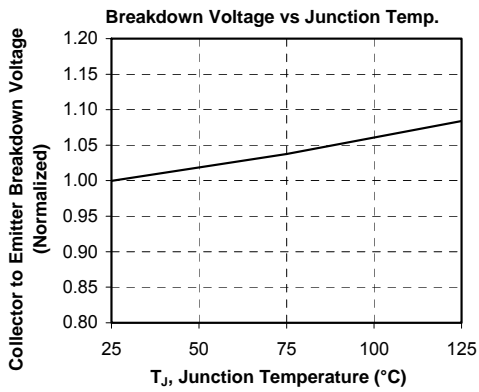
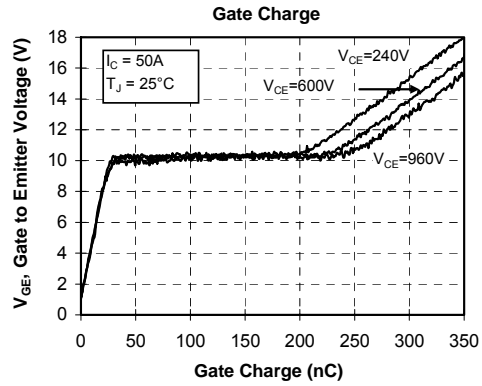
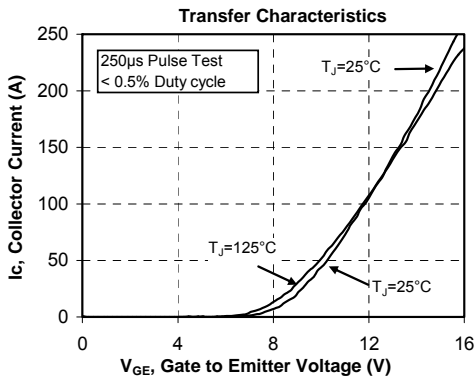
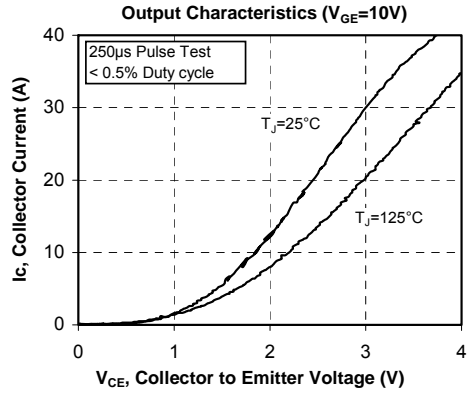
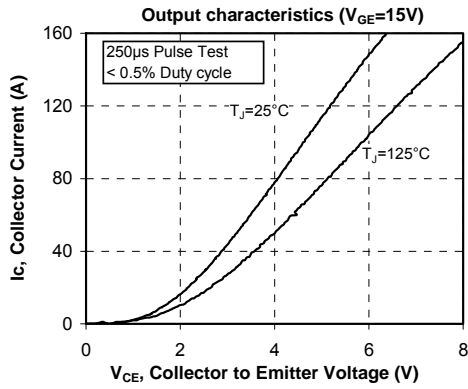

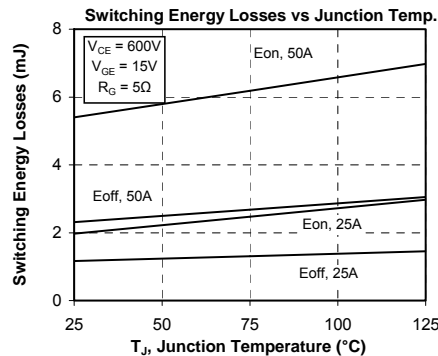
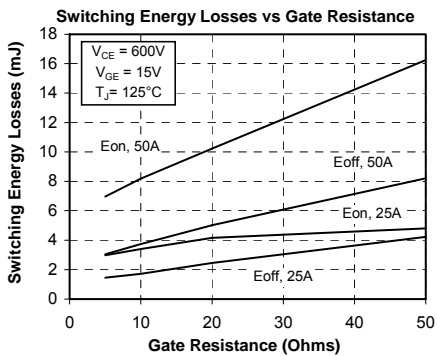
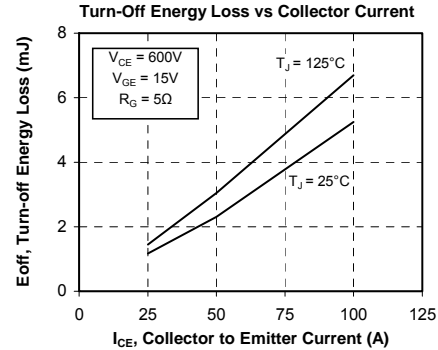
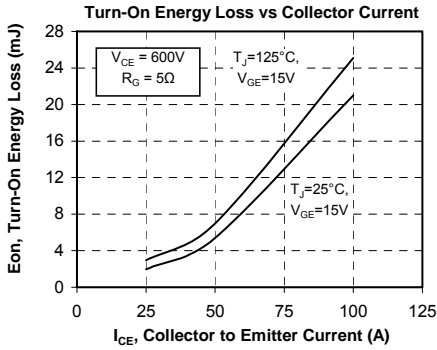
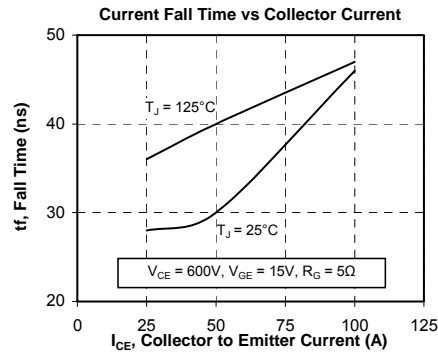
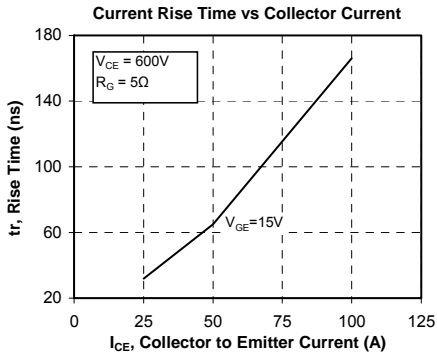
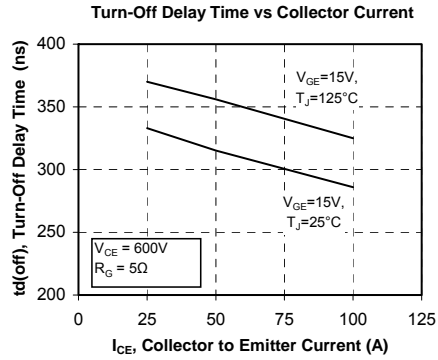
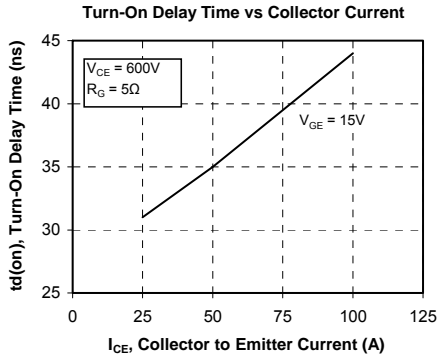

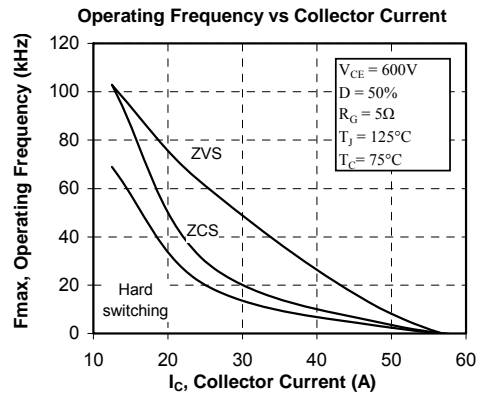
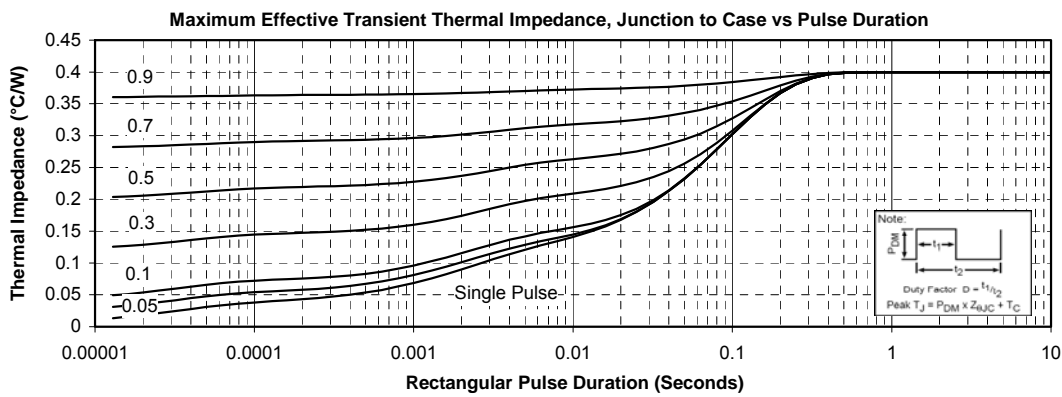
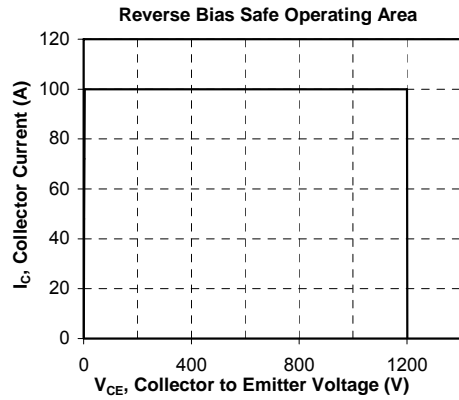
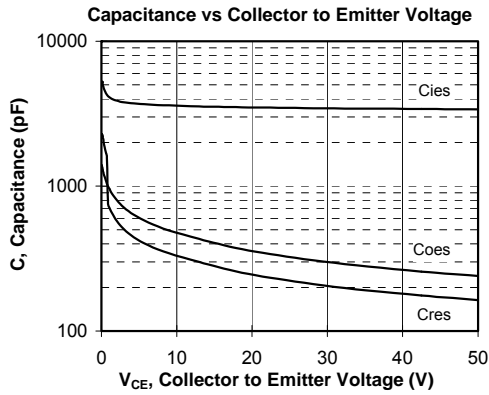

## Typical diode Performance Curve

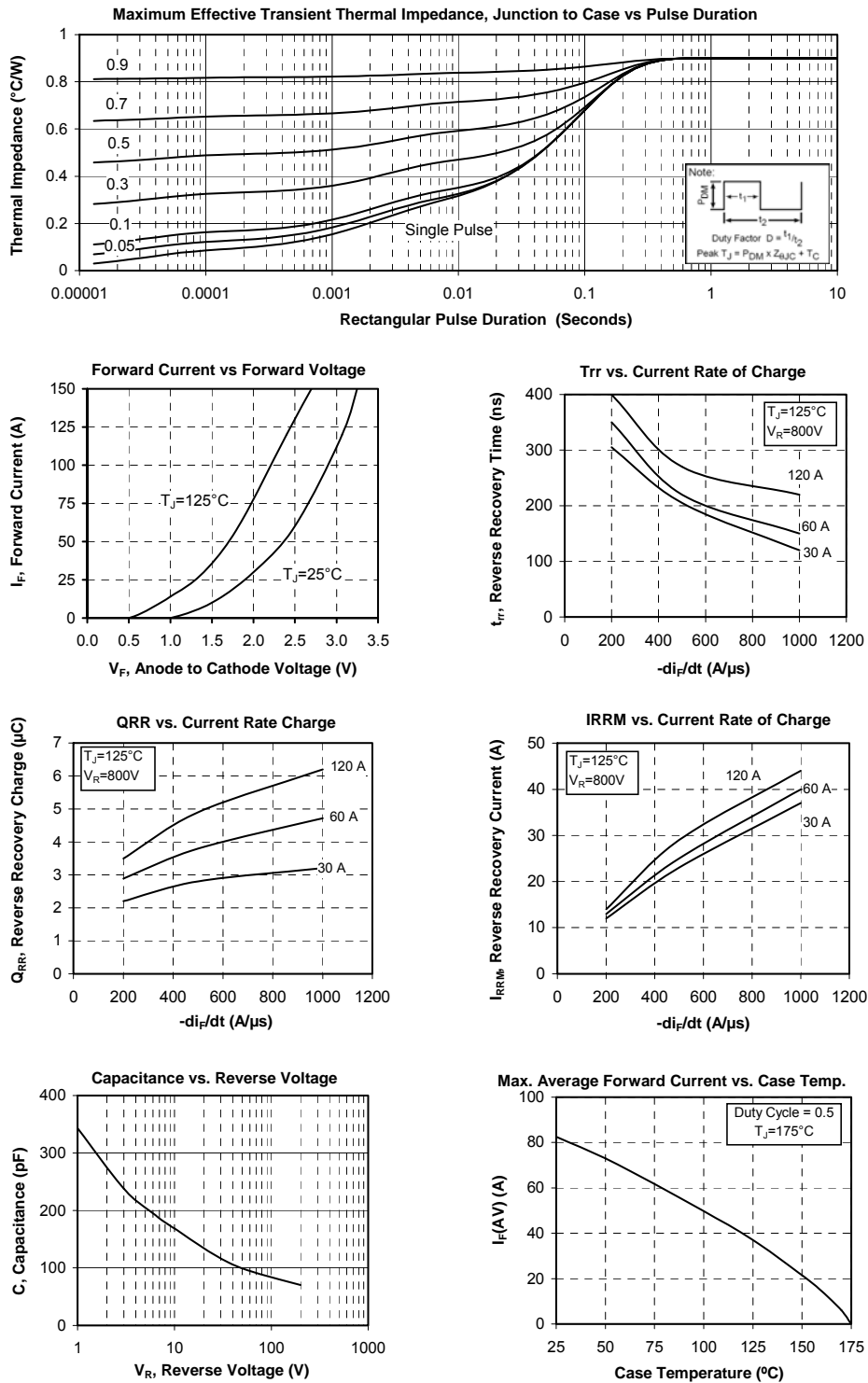

Microsemi reserves the right to change, without notice, the specifications and information contained herein

Microsemi's products are covered by one or more of U.S. patents 4,895,810 5,045,903 5,089,434 5,182,234 5,019,522 5,262,336 6,503,786 5,256,583 4,748,103 5,283,202 5,231,474 5,434,095 5,528,058 and foreign patents. U.S and Foreign patents pending. All Rights Reserved.