

Industrial Grade AC/DC Power Supply With PFC

85-264 Vrms Input Voltage	12/24/36/48 V Semi-Regulated Output	500 W Output Continuous	700 W Output Transient	Up to 90% Full Load Efficiency
------------------------------	--	----------------------------	---------------------------	-----------------------------------

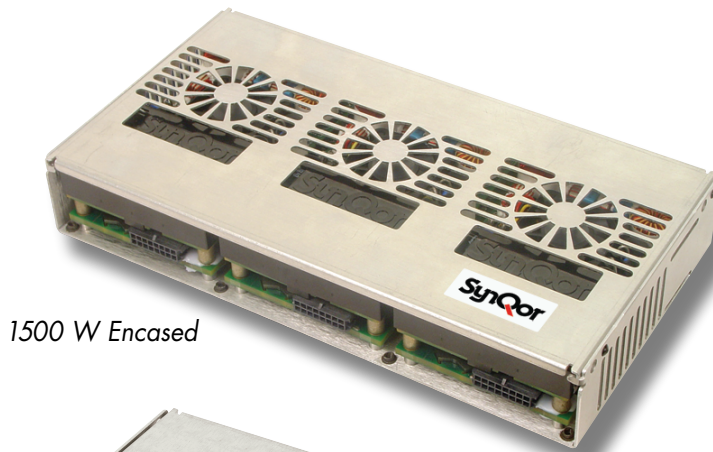

1500 W Encased

ACuQor®



1000 W Encased



500 W Encased

Package Configurations Available

Up to three units can be factory mounted into a chassis. The 500 W Single V_{out} Series can be configured as follows:

- 500 W (1 unit)
- 1000 W (2 units)
- 1500 W (3 units)

500 W Single V_{out} Series Features

- High efficiency (90% for 48 VOUT Model at 500 W)
- Universal input voltage range
- Semi-regulated output for bus stability
- Parallel operation supported
- Integral fan cooling with speed control
- Active PFC; EN61000-3-2 compliant
- Low noise; EN55011 / EN55022 Class B compliant
- Over-current, over-voltage, and over-temp protection
- DC Power Good / AC Power Good signals
- Remote enable input
- Fan status output / Fan enable input
- Small size: 3.59" x 5.25" x 1.63"
- RoHS 6/6 compliant
- 5 V (250 mW) standby output



Technical Specification

PRELIMINARY

AC Input: 85-264 V_{RMS}
DC Output: 12/24/36/48V Semi-reg.
Power: 500 W Series
Grade: Industrial

ACuQor 500W Series ELECTRICAL CHARACTERISTICS

All specifications typical with T_A = 25 °C, unless otherwise specified.

MAIN OUTPUT SPECIFICATIONS		
Output power (continuous) (5 s transient)	85-132/170-264 Vrms 85-132/170-264 Vrms 132-170 Vrms	500 W 700 W See Figures 11, 12
Nominal DC output voltage (at 250W) (Semi-regulated)	12 Vout 24 Vout 36 Vout 48 Vout	12.4 V 25 V 37.5 V 50 V
Efficiency (see figs. 1, 3, 5, 7)	12 Vout, 115 Vrms, 500 W 48 Vout, 115 Vrms, 500 W 12 Vout, 230 Vrms, 500 W 48 Vout, 230 Vrms, 500 W	86% typ. 89% typ. 88% typ. 90% typ.
Hold-up time (to -20%)	12 Vout 24 / 36 / 48 Vout	12 ms @ 500 W 16 ms @ 500 W
Maximum load capacitance	12 Vout 24 Vout 36 Vout 48 Vout	16,000 µF 8,000 µF 4,000 µF 2,000 µF
Output ripple voltage	Switching frequency (20 MHz BW) Twice line frequency (at 300W)	0.5% p-p 5.0% p-p
Turn-on delay		2 s max.
Transient response	Iout steps from 50-75% At 0.2 A/µs	3% typ / 6% max. dev. 100 ms recovery
Overvoltage protection	Cyclic restart	110-120%
Short circuit protection	Cyclic operation	115% rated Iout
Total regulation	Over line, load and temperature	±6.0%
Auxillary Output	Always on (See Note 1)	5 V @ 50 mA
Thermal protection	Automatic recovery	+125 °C (PCB Temp)
REMOTE_ENABLE	Input Low Voltage Input High Voltage	0.45 V (max) 4.15 V (min)
INPUT SPECIFICATIONS		
AC input voltage	Universal range	85-264 Vrms
Input frequency		47-63 Hz
Input current	115 Vrms @ 500 W 230 Vrms @ 500 W	5 Arms 2.5 Arms
Power factor		>0.98
Input surge current	264 Vrms (cold start)	40 A max.
Internal input fuses	Both AC lines	10.0 A

GENERAL SPECIFICATIONS		
Fundamental ripple freq.	Input Output	500 kHz 250 kHz
Audible noise	Fan speed varies with temp.	39 dBA @ 1 m max.
Weight (EQ) (RQ) (TQ)		540 g (19.1 oz) 1068 g (37.7 oz) 1582 g (55.8 oz)
MTBF	MIL-217 Demonstrated	343.6 kHours TBD kHours

ISOLATION SPECIFICATIONS		
Isolation voltage	Input to output Input to ground Output to ground	3000 Vrms 1500 Vrms 500 Vrms
Insulation resistance	Output to ground	10 MΩ min.
Leakage currents		See Note 2

ENVIRONMENTAL CHARACTERISTICS		
Thermal performance	Operating ambient (see Figure 9) Non-operating ambient	0 °C to +70 °C -40 °C to +85 °C
Relative humidity	Non-condensing	5-95% RH
Altitude	Operating Non-operating	10,000 ft max. 30,000 ft max.
Random vibration	5-500 Hz	0.03 g2/Hz
Shock	Half-sine, 10 ms, 3 axes	20 g peak

EMC CHARACTERISTICS		
Conducted emissions	EN55011 and EN55022, FCC part15	Level B
Line frequency harmonics	EN61000-3-2	Class A
Voltage fluctuations	EN61000-3-3	Clause 5b
ESD air	EN61000-4-2	Level 3
ESD contact	EN61000-4-2	Level 3
Radiated immunity	EN61000-4-3	Level 3
Fast transients	EN61000-4-4	Level 3
Line surge immunity	EN61000-4-5	Level 3
Conducted immunity	EN61000-4-6	Level 3
Power freq. mag. field	EN61000-4-8	3 A/m
Voltage dip immunity	EN61000-4-11	Perf Criteria A, A, B <5% UT 10 ms, 70% UT 500 ms, 40% UT 100 ms

SAFETY AGENCY CERTIFICATIONS (pending)	
All certification marks appear on individual unit labels.	
UL60950	
IEC/EN 60950	
CE Marked	
cUL CSA Standards	

- NOTES:
- Derate 1 mA per °C above 50 °C ambient temperature.
 - Leakage currents:

AC Leakage Current from Input to Earth	AC Line Connection	Normal Condition	Open Neutral Fault
ACuQor Typical at 110% nominal input voltage 60 Hz	240 V L-N, 1 phase	400 µA	800 µA
	208 V L-L, 120 V L-N, 1 of 3 phases	200 µA	400 µA
	240 V L-N-L, 120 V L-N, split phase	200 µA	400 µA

EFFICIENCY, DERATING, AND V_{OUT} DROOP CURVES

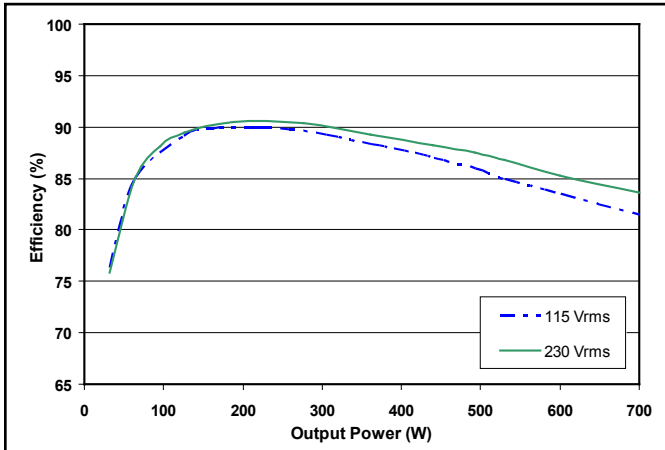

Figure 1: 12 V_{OUT} efficiency curves.

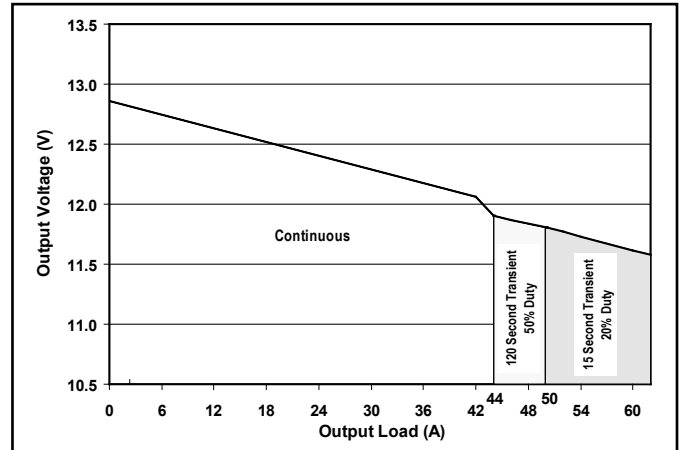

Figure 2: 12 V_{OUT} droop characteristics.

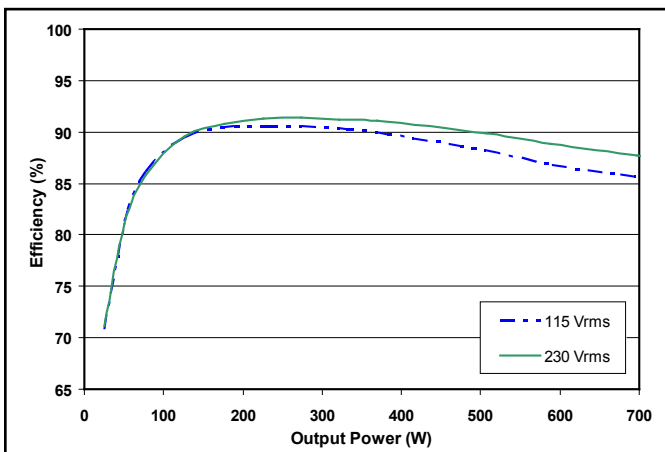

Figure 3: 24 V_{OUT} efficiency curves.

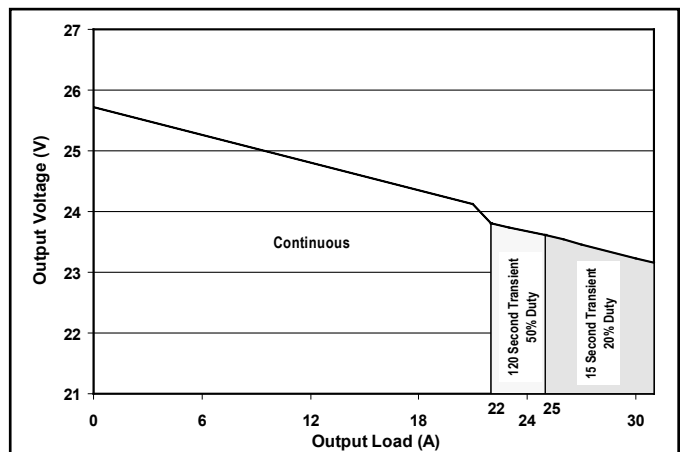

Figure 4: 24 V_{OUT} droop characteristics.

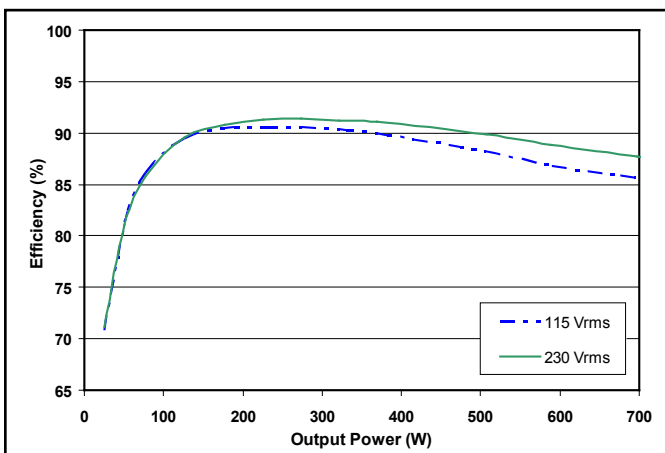

Figure 5: 36 V_{OUT} efficiency curves.

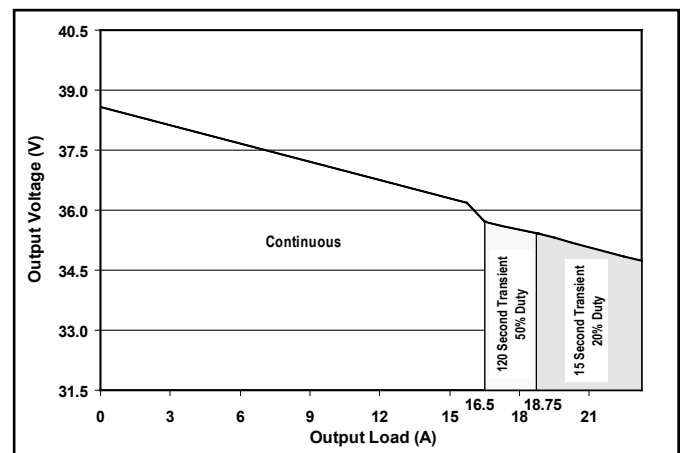

Figure 6: 36 V_{OUT} droop characteristics.

EFFICIENCY, DERATING, AND V_{OUT} DROOP CURVES

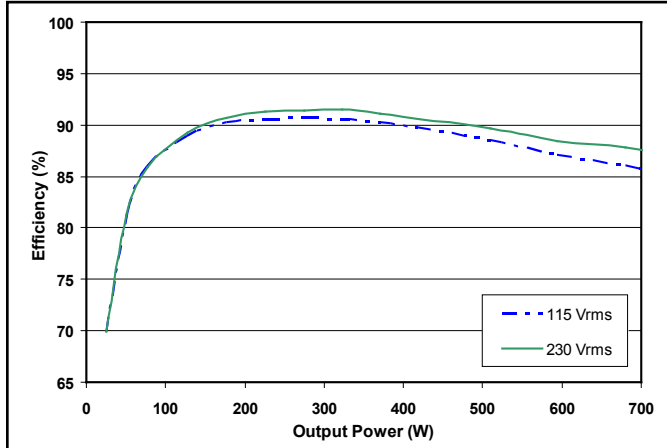

Figure 7: 48 V_{OUT} efficiency curves.

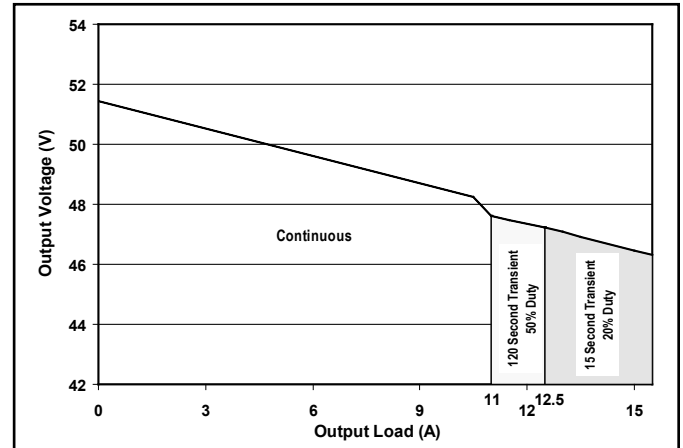

Figure 8: 48 V_{OUT} droop characteristics.

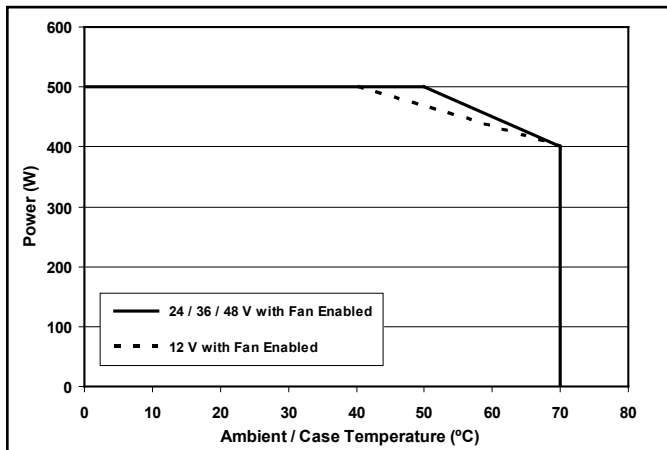

Figure 9: Continuous power derating curve in natural convection. For Fan Disabled, see Figure 10.

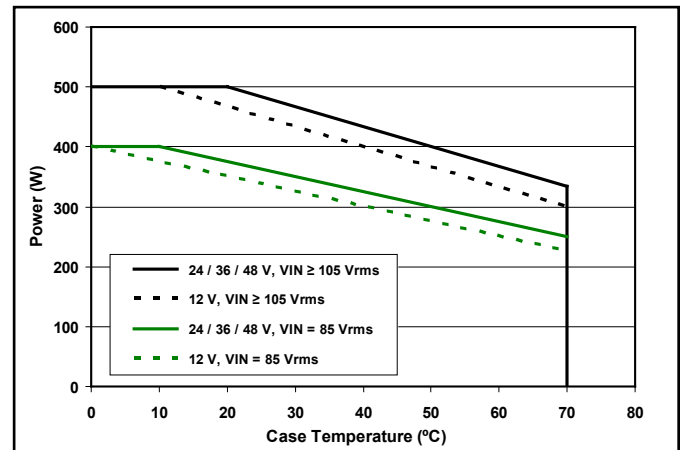

Figure 10: Fan Disabled continuous power derating curve in natural convection.

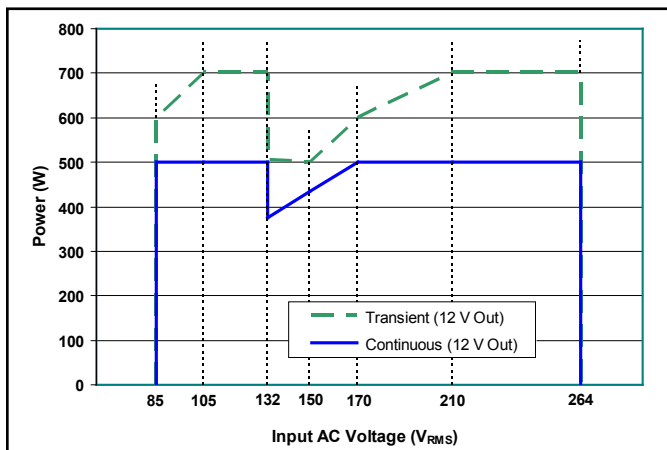

Figure 11: Rated output power vs Input AC Voltage.

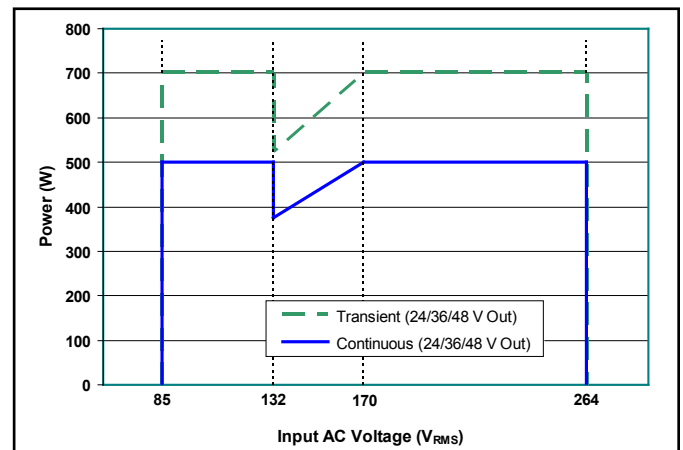

Figure 12: Rated output power vs Input AC Voltage.



Technical Specification

PRELIMINARY

AC Input: 85-264 V_{RMS}
DC Output: 12/24/36/48V Semi-reg.
Power: 500 W Series
Grade: Industrial

MECHANICAL DRAWINGS (1 Module Encased Version – E Package Type)

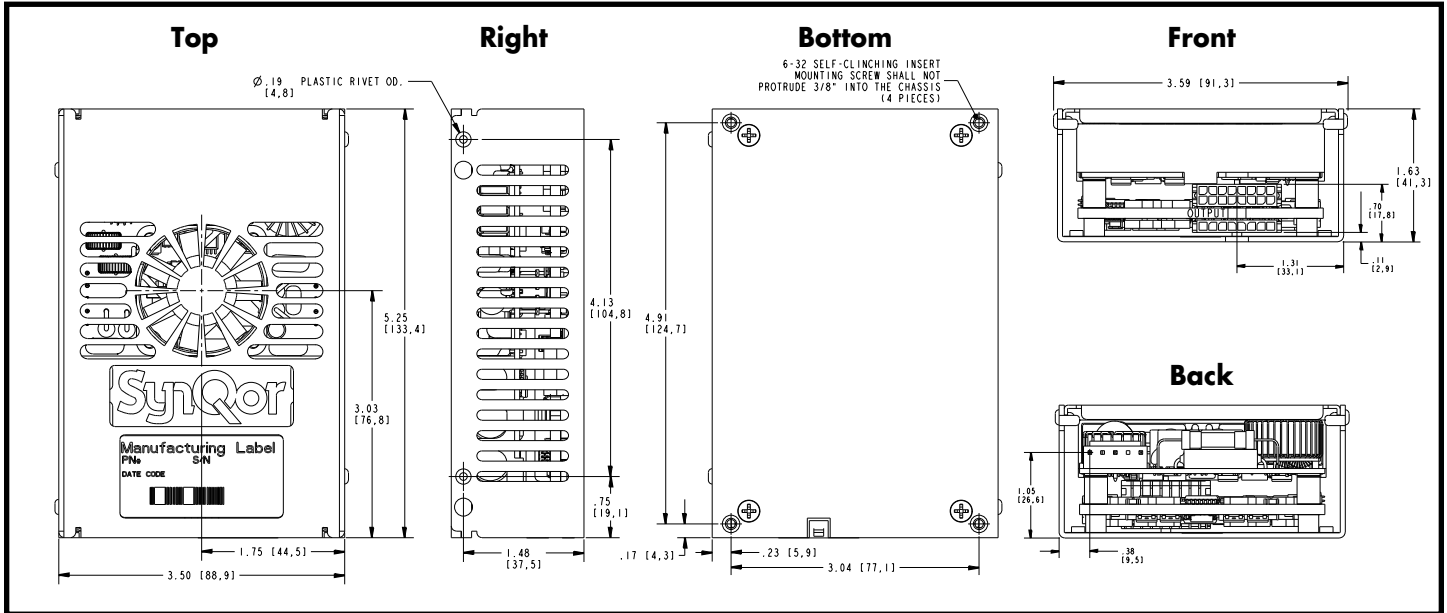

NOTES (applies to all mechanicals)

- 1) Recommended screw tightening torque of 6 in.lbs
- 2) Undimensioned components are shown for visual reference only
- 3) All dimensions in inches [mm]

Tolerances: x.xx in \pm 0.02
 x.xxx in \pm 0.010

PRELIMINARY

AC Input: 85-264 V_{RMS}
DC Output: 12/24/36/48V Semi-reg.
Power: 500 W Series
Grade: Industrial

MECHANICAL DRAWINGS (2 Modules Flat Version – R Package Type)

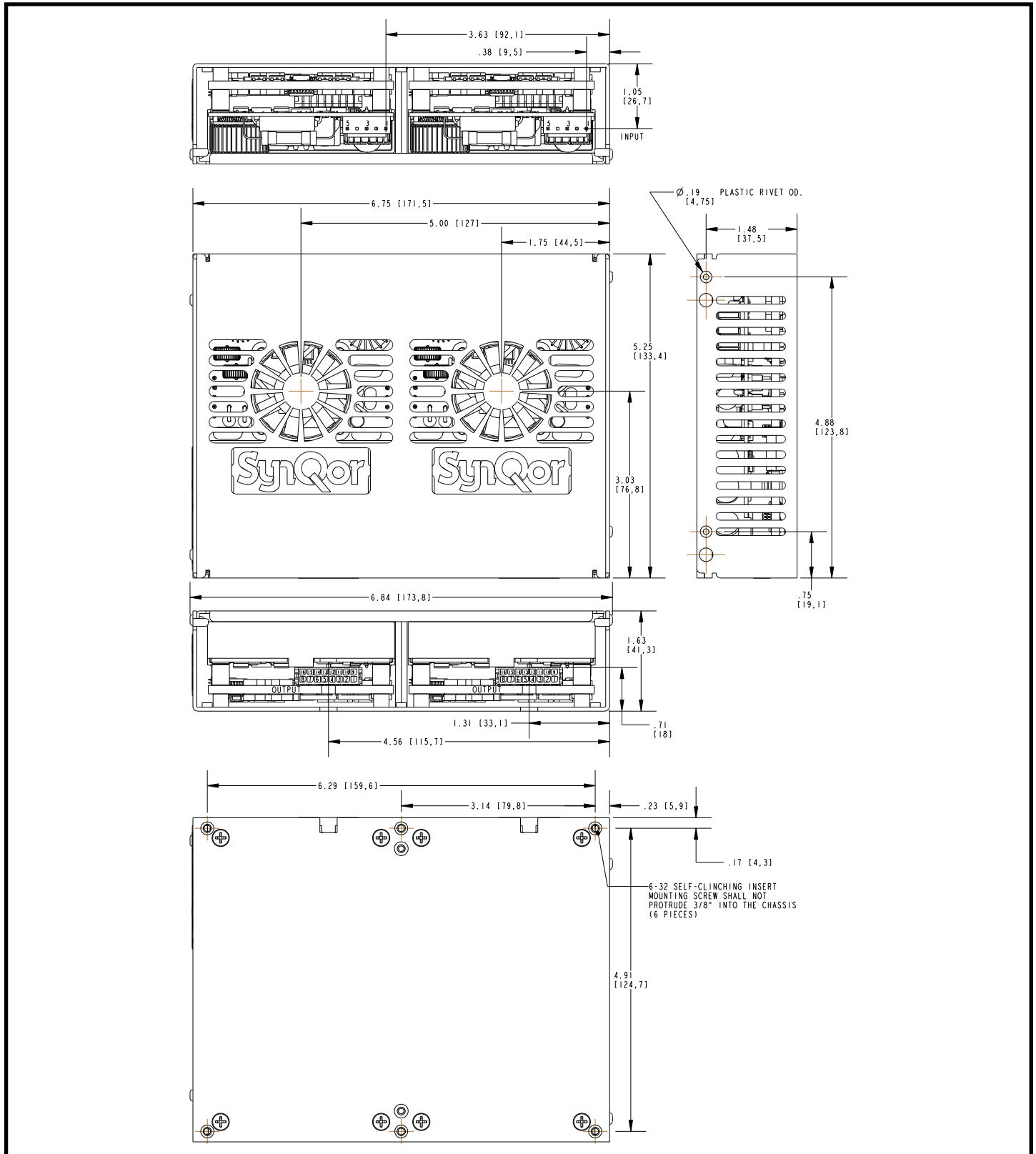



Technical Specification

PRELIMINARY

AC Input: 85-264 V_{RMS}
DC Output: 12/24/36/48V Semi-reg.
Power: 500 W Series
Grade: Industrial

MECHANICAL DRAWINGS (3 Modules Flat Version – T Package Type)

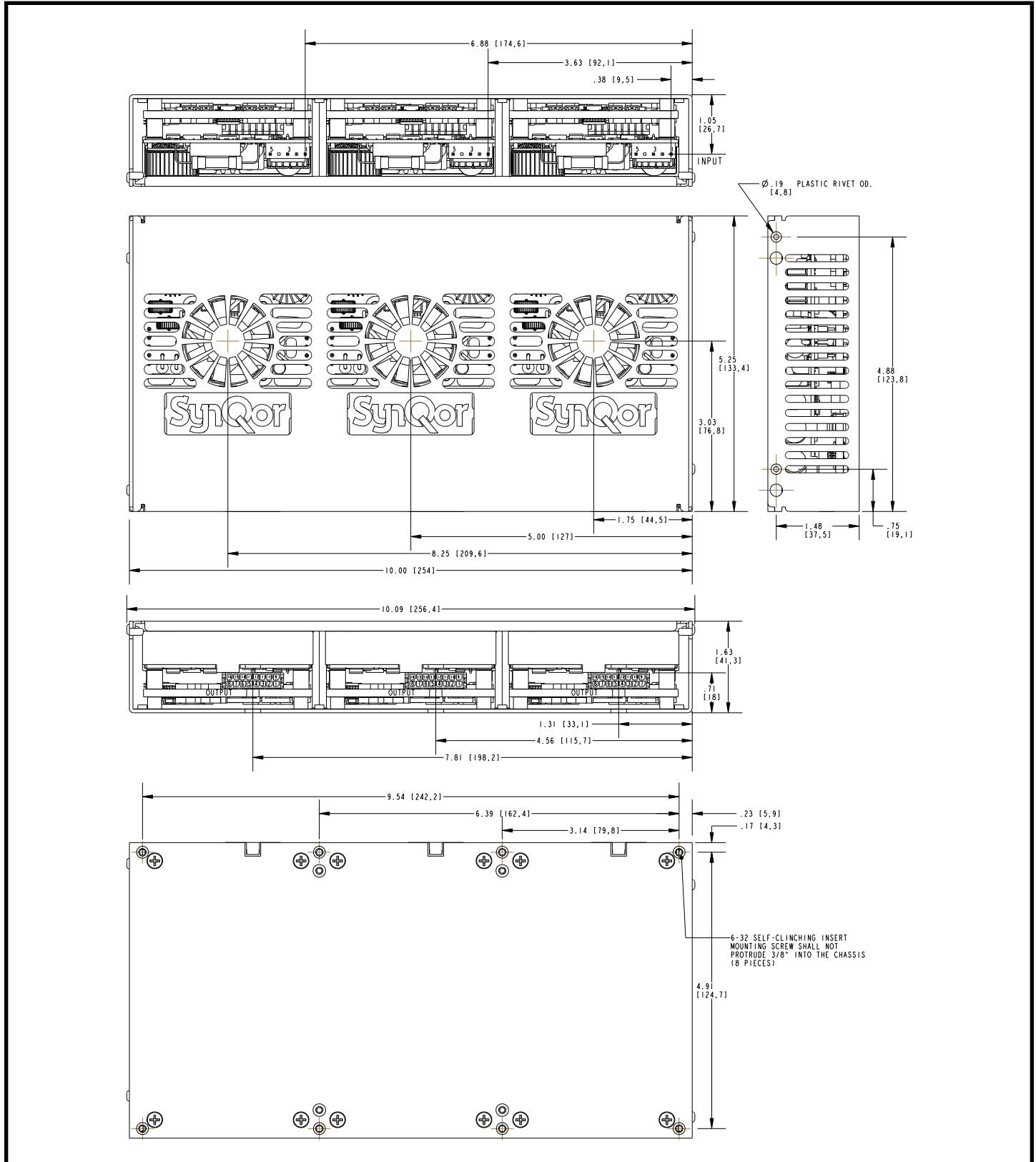

CONNECTOR DETAILS

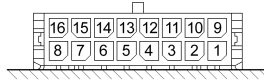

OUTPUT CONNECTOR PINOUT (top side)

Pin 1	FAN_GOOD	Open collector with internal 5V pullup. See Figure A. Pulsed low on fan failure, 100ms, 50% duty. Short to VOUT(-) to disable fan.
Pin 2	AC_POWER_GOOD	Open collector with internal 5V pullup. See Figure B. Pulled low on AC power dropout.
Pin 3	DC_POWER_GOOD	Open collector with internal 5V pullup. See Figure B. Pulled low during startup ramp and within 5 °C of temperature shutdown threshold.
Pin 4	5V_STANDBY	5 V @ 50 mA available whenever AC power is applied.
Pin 5	VOUT(+)	Positive Output Voltage.
Pin 6	VOUT(+)	Positive Output Voltage.
Pin 7	VOUT(+)	Positive Output Voltage.
Pin 8	VOUT(+)	Positive Output Voltage.
Pin 9	Reserved	Reserved for future use.
Pin 10	Reserved	Reserved for future use.
Pin 11	REMOTE_ENABLE	Logic input. See Figure C. Pull high to enable main output.
Pin 12	VOUT(-)	Negative Output Voltage.
Pin 13	VOUT(-)	Negative Output Voltage.
Pin 14	VOUT(-)	Negative Output Voltage.
Pin 15	VOUT(-)	Negative Output Voltage.
Pin 16	VOUT(-)	Negative Output Voltage.

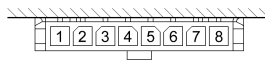

12 V OUTPUT CONNECTOR PINOUT (bottom side)

Pin 1	VOUT(+)	Positive Output Voltage.
Pin 2	VOUT(+)	Positive Output Voltage.
Pin 3	VOUT(+)	Positive Output Voltage.
Pin 4	VOUT(+)	Positive Output Voltage.
Pin 5	VOUT(-)	Negative Output Voltage.
Pin 6	VOUT(-)	Negative Output Voltage.
Pin 7	VOUT(-)	Negative Output Voltage.
Pin 8	VOUT(-)	Negative Output Voltage.

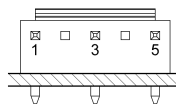

INDIVIDUAL INPUT CONNECTOR PINOUT

Pin 1	Ground
Pin 3	AC Neutral
Pin 5	AC Line

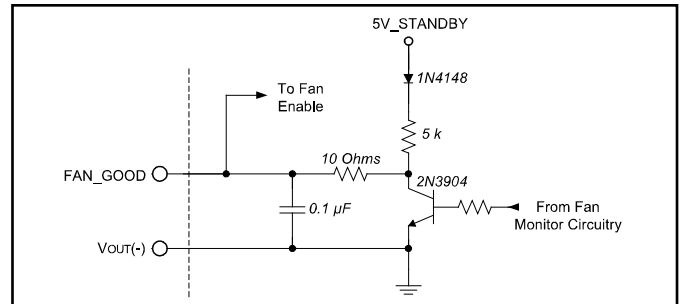

Figure A: Fan status output / Fan enable input interface circuitry.

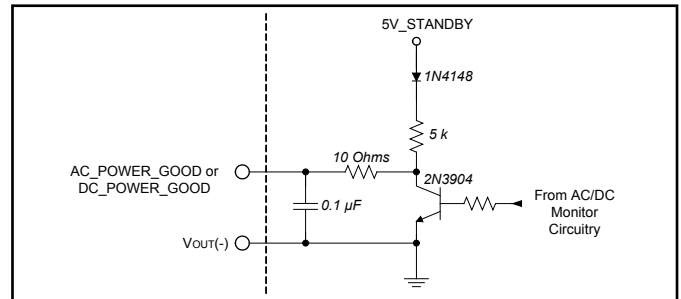

Figure B: Power good interface circuitry.

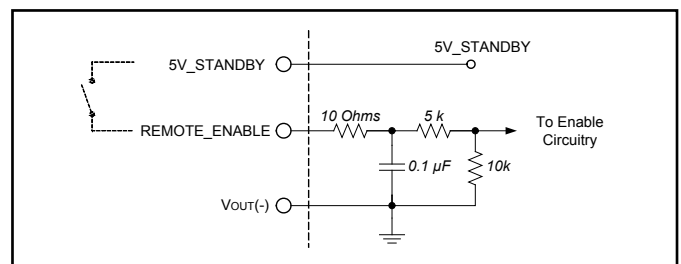

Figure C: Remote enable interface circuitry.

MATING CONNECTORS

Connector	Type	Contact
OUTPUT (16 pins)	Molex 430251600	Molex 430300008*
12V_OUTPUT (8 pins)	Molex 436450800	Molex 430300008*
INPUT	JST VHR-5N	JST SVH-41T-P1.1

* Each contact rated for a maximum of 5.5 A.

PARALLEL OPERATION - MULTIPLE UNITS

Chassis configurations for Parallel Units

ACuQor units are available either open-frame or pre-mounted at the factory. Up to 3 units can be mounted into a chassis, in either side-by-side or stacked configurations. For a complete list of options, see the "Part Numbering System" table on the last page, under "Package Type", along with the Mechanical Drawings pages. Only side-by-side configurations can be populated with 500W units, since each includes a thermal pad underneath.

Interconnection of Parallel Units

ACuQor units mounted in 2 and 3 unit chassis are not connected together. This allows the physical routing and connectivity of the external wiring to be customized to each application. The following table summarizes the recommended wiring to operate multiple units in parallel:

Specifications of Parallel Units

As a rule, units wired in parallel behave the same as single units. Any specification will remain unchanged that is expressed in units of voltage, time, frequency, or efficiency. Specifications expressed in terms of power, current, or capacitance, should be scaled by the number of units wired in parallel.

ACuQor units are individually calibrated at the factory, so that the output voltage vs. output current characteristic is always consistent (see Vout droop characteristic figures). As such, multiple units will share output current accurately. Full current is guaranteed from a bank of multiple units wired in parallel.

Output Connector Signal	Suggested Connection	Behavior with Multiple Units
REMOTE_ENABLE	Wire in parallel	Inputs activated simultaneously
FAN_GOOD	"	Wired-OR outputs – can be pulled low by any unit during an abnormal condition.
AC_POWER_GOOD	"	"
DC_POWER_GOOD	"	"
VOUT(+), VOUT(-)	"	Built-in droop characteristic ensures graceful current sharing.
12V_STANDBY*	"	"
5V_STANDBY	Do not wire in parallel	Fully regulated characteristic does not support current sharing. If placed in parallel, only the output with the highest set-point will drive current.

*Note: Triple output models only.



Technical Specification

PRELIMINARY

AC Input: 85-264 V_{RMS}
DC Output: 12/24/36/48V Semi-reg.
Power: 500 W Series
Grade: Industrial

INSTALLATION INSTRUCTIONS

General: ACuQor AC/DC power supplies are intended for use as components in industrial equipment. ACuQor units must be properly installed within end use equipment before they can be safely applied as described in this document. The suitability of the ACuQor/equipment combination must be verified through end product investigation.

Mounting: Refer to the Mechanical Drawings section. ACuQor units are provided with threaded stainless-steel stand-offs or inserts for mounting. This mounting hardware is internally connected to the input connector protective-earth terminal for functional-earth EMC control. Any orientation (vertical, horizontal, etc.) may be used. Adequate air space should be provided over the fan intake (top) and exhaust (sides) to allow for exchange of cooling air. ACuQor is designed for a pollution degree 2 environment. The suitability of the enclosed ACuQor mechanical assemblies must be verified through end product investigation.

Encased models: A minimum of 5 mm electrical clearance should be allowed from the connector ends of encased models.

Input: Refer to the Connector Details section for input connector wiring. ACuQor products require a single phase AC power source of 100-240V 50/60Hz nominal. Refer to nameplate label for input current ratings. A protective-earth connection is also required. Minimum wire size of 18 AWG (0.8mm²) is recommended. Both sides of the AC line are internally fused (see table for specific models). These fuses are not user replaceable.

Output: Refer to the Connector Details section for output connector wiring and signal I/O functionality. Refer to nameplate label for output current ratings. Main DC output (Vout+, Vout-) pins should use 20 AWG (0.5mm²) wire size. Individual main output pins should not be loaded to more than 5.5 A. For currents greater than 5.5 A, multiple main output pins/wires must be used in parallel. All signal I/O pins are referenced to Vout-.

EMC: ACuQor products have been tested to the EMC specifications listed in the Electrical Characteristics section. However, end use equipment must be tested to verify EMC compliance.

Hipot Testing: ACuQor products are rated for Hipot testing levels of 1500 Vac input to protective-earth, 500 Vac output to protective-earth, and 3000 Vac input to output. When performing the 3000 Vac input to output test, the test voltage must be balanced evenly 1500 Vac input and output to protective-earth. Two oppositely phased test voltage sources or a single test voltage source with external balancing impedances (capacitors) may be used to prevent overstressing input or output to protective-earth insulation per IEC/ENC 60950-1.

MODEL	Input Fuses (in Both AC Lines)	Fuses Total
AQ0300	Littelfuse 6.3A 250V 21606.3XEP	2
AQ0400	Littelfuse 6.3A 250V 21606.3XEP	2
AQ0500	Littelfuse 10.0A 250V 216010XEP	2



Technical Specification

PRELIMINARY

AC Input: 85-264 V_{RMS}
DC Output: 12/24/36/48V Semi-reg.
Power: 500 W Series
Grade: Industrial

PART NUMBERING SYSTEM

The part numbering system for SynQor's ACuQor AC/DC power supplies follows the format shown in the table below. Not all combinations make valid part numbers, please contact SynQor for availability.

Family	Output Power	Grade	Range	Output Voltage (xx=Standard; xT=Triple)	Package Type (Correlates to Output Power)	Thermal Design	Options
AQ ACuQor series of ac-dc semi-regulated output power supplies	0300: 300 W 0400: 400 W 0500: 500 W 0600: 600 W (2 x 300 W) 0800: 800 W (2 x 400 W) 0900: 900 W (3 x 300 W) 1000: 1000 W (2 x 500 W) 1200: 1200 W (3 x 400 W) 1500: 1500 W (3 x 500 W)	I: industrial	U: universal (85-264 V _{RMS})	12: 12 V 1T: 12 V / 5 & 12 V STBY 24: 24 V 2T: 24 V / 5 & 12 V STBY 36: 36 V 3T: 36 V / 5 & 12 V STBY 48: 48 V 4T: 48 V / 5 & 12 V STBY	E: 1 unit (3" x 5") R: 2 units; flat S: 2 units; stacked T: 3 units; flat U: 3 units; stacked	A: open frame C: encased Q: encased only	Industrial Grade: IND: Industrial

Example: AQ1000IU12RQIND

ACCESSORIES

SynQor offers a series of assemblies that can be ordered according to the table below. Mechanical drawings for these accessories are available for download in pdf format from the SynQor website.

Part Number	Description
AQ-CBL-INPUT1C	Input mating cable with pre-stripped wire ends (36" long).
AQ-CBL-OUT1C	Output mating cable with pre-stripped wire ends (18" long).
AQ-CBL-OUT1CD	Same as AQ-CBL-OUT1C with an additional 8-pin connector.
AQ-CBL-OUT2C	Output mating cable with connectors on both ends (18" long).
AQ-CBL-OUT2CD	Same as AQ-CBL-OUT2C with an additional 8-pin connector.
AQ-INSUL1M	Single module bottom-side Mylar insulator for open frame mounting.
AQ-EVAL-PRL3	Evaluation board for up to three paralleled modules.

APPLICATION NOTES

A variety of application notes and technical white papers can be downloaded in pdf format from the SynQor website.

PATENTS

SynQor holds the following patents, one or more of which might apply to this product:

5,999,417	6,222,742	6,545,890	6,577,109
6,594,159	6,731,520	6,894,468	6,896,526
6,927,987	7,050,309	7,072,190	7,085,146
7,119,524	7,269,034	7,272,021	7,272,023

Contact SynQor for further information:

Phone: 978-849-0600
Toll Free: 888-567-9596
Fax: 978-849-0602
E-mail: power@synqor.com
Web: www.synqor.com
Address: 155 Swanson Road
 Boxborough, MA 01719, USA

Warranty: SynQor offers a two (2) year limited warranty. Complete warranty information is listed on our website or is available upon request from SynQor.

Limitation on use: SynQor's products are not authorized for use and should not be used, without the specific prior written approval of an authorized officer of SynQor making specific reference hereto, in any life support system, nuclear facility or application, aircraft control application or any other application in which failure of the product could reasonably result in harm to life, property or the environment.

Information furnished by SynQor is believed to be accurate and reliable. However, no responsibility is assumed by SynQor for its use, nor for any infringements of patents or other rights of third parties which may result from its use. No license is granted by implication or otherwise under any patent or patent rights of SynQor.