



Description

The SE5509 series of fixed output low dropout linear regulators are designed for portable battery powered applications, which require low power consumption, low noise environment, and low dropout voltage. Each device contains a bandgap voltage reference, an error amplifier, a PMOS power transistor, and resistors for setting output voltage, and current limit and temperature limit protection circuits.

The SE5509 has been designed to be used with low cost capacitors and requires a minimum output capacitor of 1.0 μ F. The output voltages range from 1.3V to 4.4V in 100mV increments. Standard voltage versions are 1.5, 1.8, 2.5, 2.8, 3.0, and 3.3V.

Pin Configuration

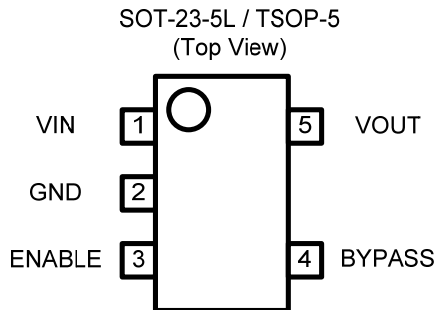

Block Diagram

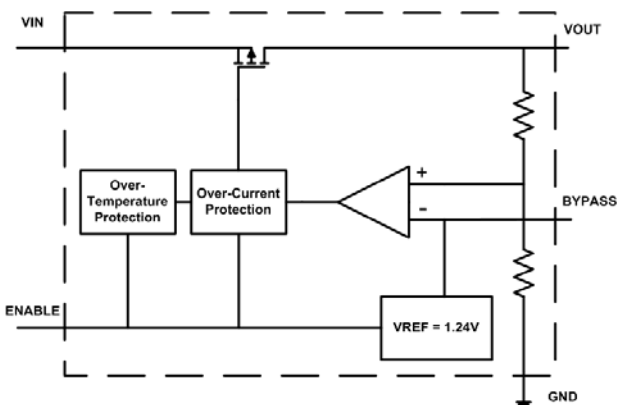

Features

- Typical 200mV Dropout Voltage at 150mA.
- Fast Enable Turn-On Time of 20 μ s (Typ.)
- Excellent Line and Load Regulation.
- High Accuracy Output Voltage of 2%.
- Ultra-Low Ground Current at 20 μ A (Typ.)
- Disable Current Less than 0.1 μ A (Typ.)
- Over Current and thermal Protection.
- No Reverse Current.
- Standard SOT-23-5L and TSOP-5 Package.

Application

- USB removable devices
- MPEG4 devices
- Wireless LAN's
- Hand-Held Instrumentation.
- Portable DVD players
- Digital camera

Ordering Information

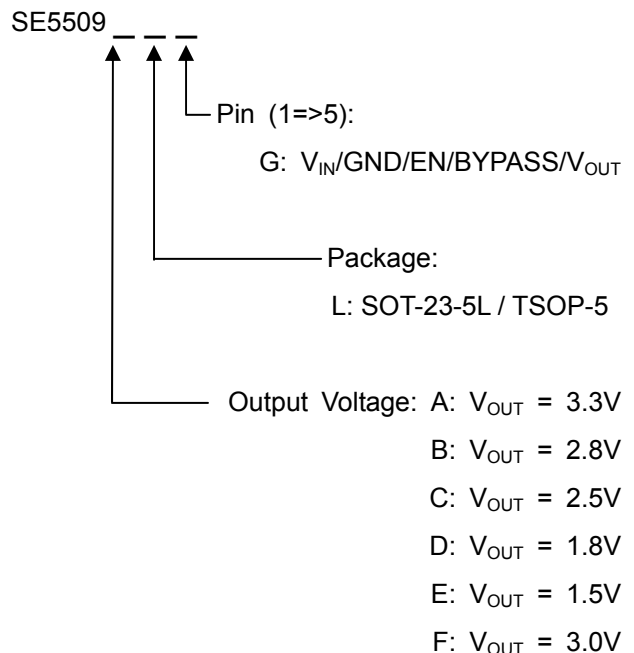



Ordering/Marking Information

Package	Ordering Information		Marking Information	
<p>SOT-23-5L / TSOP-5 (Top View)</p> <p>VIN 1 5 VOUT</p> <p>GND 2</p> <p>ENABLE 3 4 BYPASS</p>	3.3V	SE5509ALG-LF	509Alz [•]	<p>Starting with 9, a bar on top of 9 is for production year 2005, and underlined 9 is for year 2006. The naming pattern continues with consecutive characters for later years.</p> <p>The last character is the week code. (A-Z: 1-26, a-z: 27-52)</p> <p>A dot on top right corner is for lead-free process. LF: lead free.</p>
	2.8V	SE5509BLG-LF	509BLz [•]	
	2.5V	SE5509CLG-LF	509CLz [•]	
	1.8V	SE5509DLG-LF	509DLz [•]	
	1.5V	SE5509ELG-LF	509ELz [•]	
	3.0V	SE5509FLG-LF	509FLz [•]	

Absolute Maximum Rating ⁽¹⁾

Parameter	Symbol	Value	Units
Input Voltage	V _{IN}	6	V
Enable Voltage	V _{EN}	-0.3 to V _{IN}	V
Output Voltage	V _{OUT}	-0.3 to 4.6	V
Power Dissipation	P _D	Internally Limited ⁽³⁾	
Output Short Circuit Duration		Infinite	
Thermal Resistance, Junction-to-Ambient	Θ _{JA}	230	°C/W
Lead Temperature (Soldering, 5 sec.)		260	°C
Junction Temperature	T _J	0 to +150	°C
Storage Temperature	T _S	-40 to +150	°C

Operating Rating ⁽²⁾

Parameter	Symbol	Value	Units
Supply Input Voltage Range	V _{IN}	5.5	V
Junction Temperature Range	T _J	0 to +125	°C

Electrical Characteristics

V_{IN} = 5V; V_{EN}=V_{IN}; C_{IN} = 2.2μF; C_{OUT} = 2.2μF; I_{OUT} = 10mA; T_J = 25°C; unless otherwise noted

Symbol	Parameter	Conditions	Min	Typ	Max	Unit
V _{OUT}	Output Voltage Accuracy	SE5509 – 1.5 (V _{IN} =1.8V)	1.470	1.5	1.530	V
		SE5509 – 1.8 (V _{IN} =3.3V)	1.764	1.8	1.836	
		SE5509 – 2.5	2.450	2.5	2.550	
		SE5509 – 2.8	2.744	2.8	2.856	
		SE5509 – 3.0	2.940	3.0	3.060	
		SE5509 – 3.3	3.234	3.3	3.366	
ΔV _{OUT}	Line Regulation	V _{IN} = (V _{OUT} + 0.8)V to 5.5V	--	0.2	--	%/V
ΔV _{OUT}	Load Regulation ⁽⁵⁾	V _{IN} = (V _{OUT} + 0.8)V or 2.5V I _{OUT} = 10mA to 300mA	--	2.0	--	%



Electrical Characteristics (Continued)

$V_{IN} = 5V$; $C_{IN} = 2.2\mu F$; $C_{OUT} = 2.2\mu F$; $I_{OUT} = 10mA$; $T_J = 25^\circ C$; unless otherwise noted

Symbol	Parameter	Conditions	Min	Typ	Max	Unit
$\Delta V_{OUT}/\Delta T$	Output Voltage Temperature Coefficient	Note 4	--	0.1	--	mV/°C
$V_{IN} - V_{OUT}$	Dropout Voltage ⁽⁶⁾ ($V_{OUT} > 3.0V$)	$I_{OUT} = 10mA$	--	8	--	mV
		$I_{OUT} = 150mA$	--	200	--	
		$I_{OUT} = 300mA$	--	350	--	
$T_{PROTECTION}$	Thermal Protection	Thermal Protection Temperature	--	150	--	°C
		Protection Hysterisys	--	20	--	
PSRR	Ripple Rejection	$f = 10kHz, I_{OUT} = 50mA, C_{bypass} = 0.1\mu F$	--	70	--	dB
I_Q	Quiescent Current	$V_{EN} = 0.4V$	--	0.1	--	μA
		$V_{EN} = V_{IN}$	--	20	--	
$V_{TH(EN)}$	Enable Input Threshold Voltage	Voltage Raising, Output Turns On, Logic High	1.6	--	--	V
		Voltage Falling, Output Turns Off, Logic Low	--	--	0.4	
I_{LIMIT}	Current Limit		--	600	--	mA

Note 1: Exceeding the absolute maximum rating may damage the device.

Note 2: The device is not guaranteed to function outside its operating rating.

Note 3: The maximum allowable power dissipation at any T_A (ambient temperature) is calculated using: $P_{D(MAX)} = (T_{J(MAX)} - T_A)/\theta_{JA}$. Exceeding the maximum allowable power dissipation will result in excessive die temperature, and the regulator will go into thermal shutdown. See "Thermal Consideration" section for details

Note 4: Output voltage temperature coefficient is the worst case voltage change divided by the total temperature range.

Note 5: Regulation is measured at constant junction temperature using low duty cycle pulse testing. Parts are tested for load regulation in the load range from 0.1mA to 300mA. Changes in output voltage due to heating effects are covered by the thermal regulation specification.

Note 6: Dropout voltage is defined as the input to output differential at which the output voltage drops 100mV below its nominal value measured at 0.8V differential.

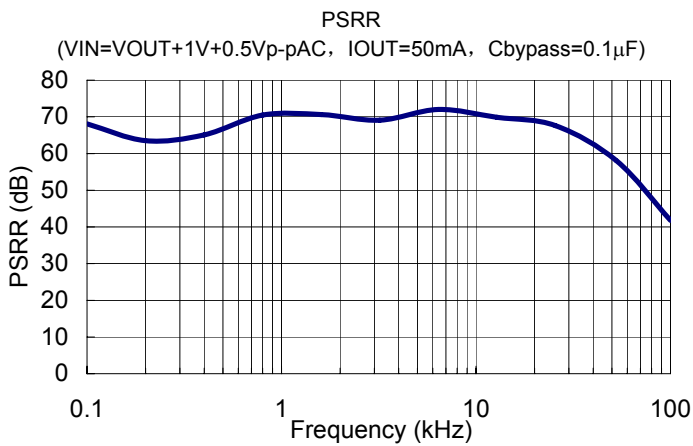
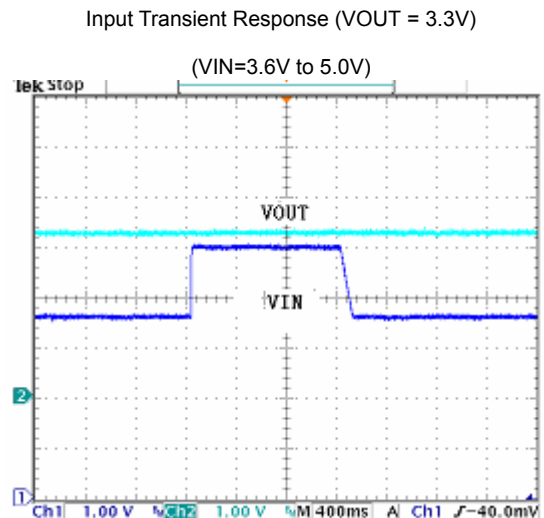
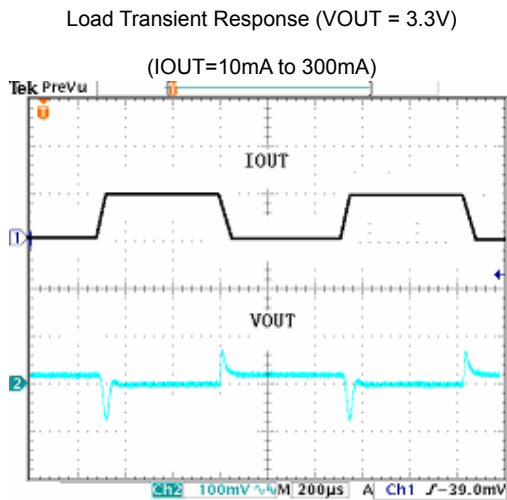
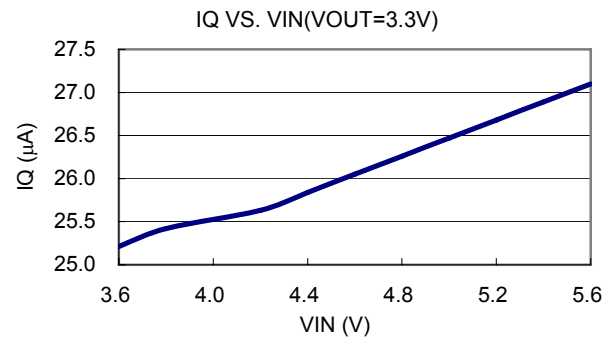
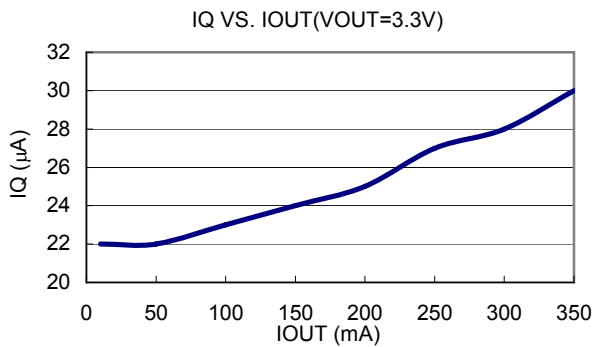
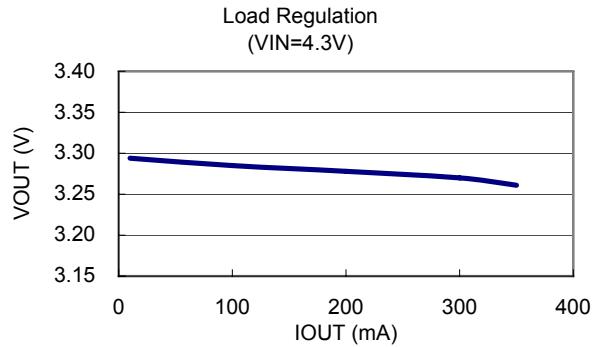
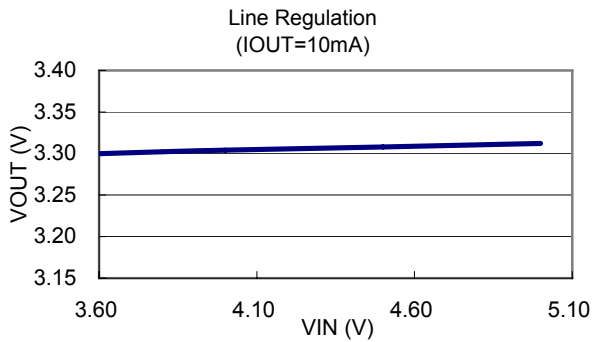



Application Hints

Like any low dropout regulator, SE5509 requires external capacitors to ensure stability. The external capacitors must be carefully selected to ensure performance.

Input Capacitor

An input capacitor of at least 1µF is required. Ceramic or Tantalum can be used. The value can be increase without upper limit.

Output Capacitor

An output capacitor is required for stability. It must be placed no more than 1 cm away from the V_{OUT} pin, and connected directly between V_{OUT} and GND pins. Electrolytical capacitor is recommended. The minimum value is 1µF but may be increase without limit. Ceramic can be used. But the value should not be more than 2.2µF.

Thermal Considerations

It is important that the thermal limit of the package is not exceeded. The SE5509 has built-in thermal protection. When the thermal limit is exceeded, the IC will enter protection, and V_{OUT} will be pulled to ground. The power dissipation for a given application can be calculated as following:

The power dissipation (P_D) is

$$P_D = I_{OUT} * [V_{IN} - V_{OUT}]$$

The thermal limit of the package is then limited to $P_{D(MAX)} = [T_J - T_A]/\Theta_{JA}$ where T_J is the junction temperature, T_A is the ambient temperature, and Θ_{JA} is around 230°C/W for SE5509. SE5509 is designed to enter thermal protection at 150°C. For example, if T_A is 25°C then the maximum P_D is limited to about 0.6W. In other words, if I_{OUT(MAX)} = 300mA, then [V_{IN} - V_{OUT}] cannot exceed 2V.

Application Diagram

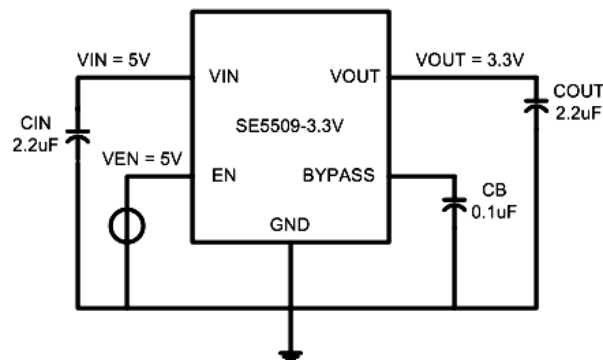



OUTLINE DRAWING SOT-23-5L

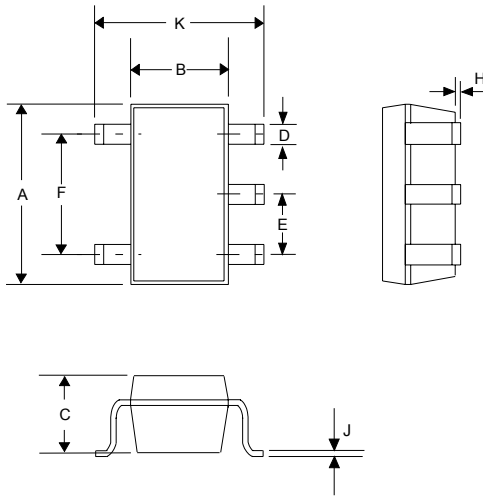

DIMENSIONS				
DIM ^N	INCHES		MM	
	MIN	MAX	MIN	MAX
A	0.110	0.120	2.80	3.05
B	0.059	0.070	1.50	1.75
C	0.036	0.051	0.90	1.30
D	0.014	0.020	0.35	0.50
E	-	0.037	-	0.95
F	-	0.075	-	1.90
H	-	0.006	-	0.15
J	0.0035	0.008	0.090	0.20
K	0.102	0.118	2.60	3.00

OUTLINE DRAWING TSOP-5

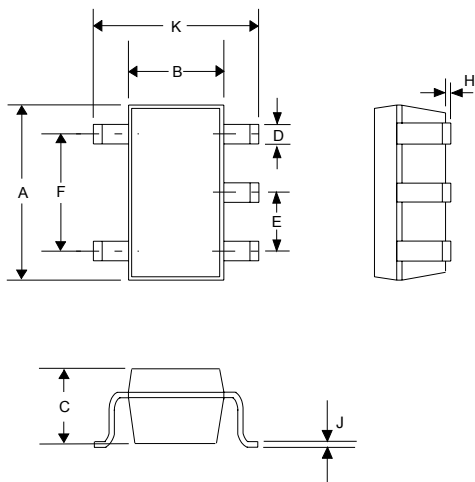

DIMENSIONS				
DIM ^N	INCHES		MM	
	MIN	MAX	MIN	MAX
A	0.110	0.120	2.80	3.05
B	0.059	0.070	1.50	1.75
C	0.036	0.040	0.90	1.00
D	0.014	0.020	0.35	0.50
E	-	0.037	-	0.95
F	-	0.075	-	1.90
H	-	0.006	-	0.15
J	0.0035	0.008	0.090	0.20
K	0.102	0.118	2.60	3.00



Customer Support

Seaward Electronics Incorporated – China

Section B, 2nd Floor, ShangDi Scientific Office Complex, #22 XinXi Road

Haidian District, Beijing 100085, China

Tel: 86-10-8289-5700/01/05

Fax: 86-10-8289-5706

Seaward Electronics Corporation – Taiwan

2F, #181, Sec. 3, Minquan East Rd,

Taipei, Taiwan R.O.C

Tel: 886-2-2712-0307

Fax: 886-2-2712-0191

Seaward Electronics Incorporated – North America

1512 Centre Pointe Dr.

Milpitas, CA95035, USA

Tel: 1-408-821-6600

Last Updated - 12/5/2008