

Precision, Low Noise FGA™ Voltage References

The ISL21060 FGA™ voltage references are low power, high precision voltage references fabricated on Intersil's proprietary Floating Gate Analog technology. A new disable feature allows the device to shut down the output and reduce supply current drain from 15µA operating to <500nA.

The ISL21060 family features guaranteed initial accuracy as low as ±1.0mV with drift down to 10ppm/°C. Noise is typically 10µV_{P-P} (10Hz BW). This combination of high initial accuracy, low power and low output noise performance of the ISL21060 enables versatile high performance control and data acquisition applications with low power consumption.

Pinout

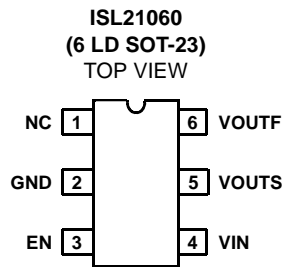

Features

- Reference Output Voltage 2.048V, 2.500V, 3.000V, 3.300V, 4.096V
- Initial Accuracy ±1.0mV, ±2.5mV
- Input Voltage Range
 - ISL21060-20 2.5V to 5.5V
 - ISL21060-25 2.7V to 5.5V
 - ISL21060-30 3.2V to 5.5V
 - ISL21060-33 3.5V to 5.5V
 - ISL21060-41 4.3V to 5.5V
- Output Voltage Noise 10µV_{P-P} (0.1Hz to 10Hz)
- Supply Current 40µA (Max)
- Tempco. 10ppm/°C, 25ppm/°C
- Output Current Capability. +10.0mA/-5mA
- Operating Temperature Range. -40°C to +125°C
- Package 6 Ld SOT-23
- Pb-Free (RoHS compliant)

Applications

- High Resolution A/Ds and D/As
- Digital Meters
- Bar Code Scanners
- Basestations
- Battery Management/Monitoring
- Industrial/Instrumentation Equipment

Pin Descriptions

PIN NUMBER	PIN NAME	DESCRIPTION
1	NC	No Connect; Do Not Connect
2	GND	Ground Connection
3	EN	Enable Input. Active High. Do not Float.
4	VIN	Input Voltage Connection
5	VOUTS	Voltage Reference Output Connection (Sense)
6	VOUTF	Voltage Reference Output Connection (Force)

Ordering Information

PART NUMBER (Note)	PART MARKING	V _{OUT} OPTION (V)	GRADE (mV)	TEMP. RANGE (ppm/°C)	PACKAGE (Pb-Free)	PKG. DWG. #
ISL21060BFH620Z-TK*	GACB	2.048	1.0	10	6 Ld SOT-23	MDP0038
ISL21060CFH620Z-TK*	GACD	2.048	2.5	25	6 Ld SOT-23	MDP0038
ISL21060BFH625Z-TK*	GAEA	2.500	1.0	10	6 Ld SOT-23	MDP0038
ISL21060CFH625Z-TK*	GAGA	2.500	2.5	25	6 Ld SOT-23	MDP0038
ISL21060BFH630Z-TK*	GAHA	3.000	1.0	10	6 Ld SOT-23	MDP0038
ISL21060CFH630Z-TK*	GAJA	3.000	2.5	25	6 Ld SOT-23	MDP0038
ISL21060CFH633Z-TK*	GAPA	3.300	2.5	25	6 Ld SOT-23	MDP0038
ISL21060BFH641Z-TK*	GACC	4.096	1.0	10	6 Ld SOT-23	MDP0038
ISL21060CFH641Z-TK*	GACE	4.096	2.5	25	6 Ld SOT-23	MDP0038

*Please refer to TB347 for details on reel specifications.

NOTE: These Intersil Pb-free plastic packaged products employ special Pb-free material sets, molding compounds/die attach materials, and 100% matte tin plate plus anneal (e3 termination finish, which is RoHS compliant and compatible with both SnPb and Pb-free soldering operations). Intersil Pb-free products are MSL classified at Pb-free peak reflow temperatures that meet or exceed the Pb-free requirements of IPC/JEDEC J STD-020.

Absolute Voltage Ratings

Max Voltage	
V_{IN} to GND	-0.5V to +6.5V
V_{OUT} to GND (10s)	-0.5V to $V_{OUT} + 1V$
Voltage on "DNC" pins	No connections permitted to these pins
ESD Rating	
Human Body Model	.5500V
Machine Model	.550V
Charged Device Model	.2kV

Thermal Information

Thermal Resistance (Typical, Note 1)	θ_{JA} (°C/W)
6 Ld SOT-23	230
Continuous Power Dissipation ($T_A = +70^\circ\text{C}$, Note 3)	
Storage Temperature Range	-65°C to +150°C
6 Ld SOT-23, derate	
5.88mW/°C above +70°C	471mW
Pb-free Reflow Profile (Note 2)	see link below
	http://www.intersil.com/pbfree/Pb-FreeReflow.asp

Recommended Operating Conditions

Temperature Range (Industrial) -40°C to +125°C

CAUTION: Do not operate at or near the maximum ratings listed for extended periods of time. Exposure to such conditions may adversely impact product reliability and result in failures not covered by warranty.

IMPORTANT NOTE: All parameters having Min/Max specifications are guaranteed. Typ values are for information purposes only. Unless otherwise noted, all tests are at the specified temperature and are pulsed tests, therefore: $T_J = T_C = T_A$

NOTE:

- θ_{JA} is measured with the component mounted on a high effective thermal conductivity test board in free air. See Tech Brief TB379 for details.
- Post-reflow drift for the ISL21060 devices will range from 100 μV to 1.0mV based on experimental results with devices on FR4 double sided boards. The design engineer must take this into account when considering the reference voltage after assembly.

Electrical Specifications (ISL21060-20, $V_{OUT} = 2.048V$) $V_{IN} = 3.0V$, $T_A = -40^\circ\text{C}$ to $+125^\circ\text{C}$, $I_{OUT} = 0$, unless otherwise specified.

PARAMETER	DESCRIPTION	CONDITIONS	MIN	TYP	MAX	UNIT
V_{OUT}	Output Voltage			2.048		V
V_{OA}	V_{OUT} Accuracy @ $T_A = +25^\circ\text{C}$	ISL21060B20	-1.0		+1.0	mV
		ISL21060C20	-2.5		+2.5	mV
TC V_{OUT}	Output Voltage Temperature Coefficient (Note 3)	ISL21060B			10	ppm/°C
		ISL21060C			25	ppm/°C
V_{IN}	Input Voltage Range		2.5		5.5	V
I_{IN}	Supply Current	$V_{EN} = V_{IN}$		16	40	μA
$\Delta V_{OUT}/\Delta V_{IN}$	Line Regulation	$2.5V \leq V_{IN} \leq 5.5V$		50	150	$\mu\text{V}/\text{V}$
$\Delta V_{OUT}/\Delta I_{OUT}$	Load Regulation	Sourcing: $0\text{mA} \leq I_{OUT} \leq 10\text{mA}$		3	50	$\mu\text{V}/\text{mA}$
		Sinking: $-5\text{mA} \leq I_{OUT} \leq 0\text{mA}$		150	400	$\mu\text{V}/\text{mA}$
I_{SC}	Short Circuit Current	$T_A = +25^\circ\text{C}$, V_{OUT} tied to GND		50		mA
t_R	Turn-on Settling Time	$V_{OUT} = \pm 0.1\%$		300		μs
	Ripple Rejection	$f = 10\text{kHz}$		75		dB
e_N	Output Voltage Noise	$0.1\text{Hz} \leq f \leq 10\text{Hz}$		10		μV_{P-P}
V_N	Broadband Voltage Noise	$10\text{Hz} \leq f \leq 1\text{kHz}$		2.5		μV_{RMS}
	Noise Density	$f = 1\text{kHz}$		60		$\text{nV}/\sqrt{\text{Hz}}$
$\Delta V_{OUT}/\Delta T_A$	Thermal Hysteresis (Note 4)	$\Delta T_A = +165^\circ\text{C}$		100		ppm
$\Delta V_{OUT}/\Delta t$	Long Term Stability (Note 5)	$T_A = +25^\circ\text{C}$		100		ppm
OUTPUT DISABLE						
V_{ENH}	Enable Logic High (ON)		1.6			V
V_{ENL}	Enable Logic Low (OFF)				0.8	V
I_{INSD}	Shutdown Supply Current	$V_{EN} \leq 0.35V$		0.4	1.5	μA

ISL21060

Electrical Specifications (ISL21060-25, $V_{OUT} = 2.500V$) $V_{IN} = 3.0V$, $T_A = -40^{\circ}C$ to $+125^{\circ}C$, $I_{OUT} = 0$, unless otherwise specified.

PARAMETER	DESCRIPTION	CONDITIONS	MIN	TYP	MAX	UNIT
V_{OUT}	Output Voltage			2.500		V
V_{OA}	V_{OUT} Accuracy @ $T_A = +25^{\circ}C$	ISL21060B25	-1.0		+1.0	mV
		ISL21060C25	-2.5		+2.5	mV
TC V_{OUT}	Output Voltage Temperature Coefficient (Note 3)	ISL21060B			10	ppm/ $^{\circ}C$
		ISL21060C			25	ppm/ $^{\circ}C$
V_{IN}	Input Voltage Range		2.7		5.5	V
I_{IN}	Supply Current	$V_{EN} = V_{IN}$		16	40	μA
$\Delta V_{OUT} / \Delta V_{IN}$	Line Regulation	$2.7V \leq V_{IN} \leq 5.5V$		50	150	$\mu V/V$
$\Delta V_{OUT} / \Delta I_{OUT}$	Load Regulation	Sourcing: $0mA \leq I_{OUT} \leq 10mA$		3	150	$\mu V/mA$
		Sinking: $-5mA \leq I_{OUT} \leq 0mA$		130	400	$\mu V/mA$
I_{SC}	Short Circuit Current	$T_A = +25^{\circ}C$, V_{OUT} tied to GND		50		mA
t_R	Turn-on Settling Time	$V_{OUT} = \pm 0.1\%$		300		μs
	Ripple Rejection	$f = 10kHz$		75		dB
e_N	Output Voltage Noise	$0.1Hz \leq f \leq 10Hz$		10		μV_{P-P}
V_N	Broadband Voltage Noise	$10Hz \leq f \leq 1kHz$		2.5		μV_{RMS}
	Noise Density	$f = 1kHz$		60		nV/\sqrt{Hz}
$\Delta V_{OUT} / \Delta T_A$	Thermal Hysteresis (Note 4)	$\Delta T_A = +165^{\circ}C$		100		ppm
$\Delta V_{OUT} / \Delta t$	Long Term Stability (Note 5)	$T_A = +25^{\circ}C$		100		ppm
OUTPUT DISABLE						
V_{ENH}	Enable Logic High (ON)		1.6			V
V_{ENL}	Enable Logic Low (OFF)				0.8	V
I_{INSD}	Shutdown Supply Current	$V_{EN} \leq 0.35V$		0.4	1.5	μA

Electrical Specifications (ISL21060-30, $V_{OUT} = 3.000V$) $V_{IN} = 3.5V$, $T_A = -40^{\circ}C$ to $+125^{\circ}C$, $I_{OUT} = 0$, unless otherwise specified.

PARAMETER	DESCRIPTION	CONDITIONS	MIN	TYP	MAX	UNIT
V_{OUT}	Output Voltage			3.000		V
V_{OA}	V_{OUT} Accuracy @ $T_A = +25^{\circ}C$	ISL21060B30	-1.0		+1.0	mV
		ISL21060C30	-2.5		+2.5	mV
TC V_{OUT}	Output Voltage Temperature Coefficient (Note 3)	ISL21060B			10	ppm/ $^{\circ}C$
		ISL21060C			25	ppm/ $^{\circ}C$
V_{IN}	Input Voltage Range		3.2		5.5	V
I_{IN}	Supply Current	$V_{EN} = V_{IN}$		16	40	μA
$\Delta V_{OUT} / \Delta V_{IN}$	Line Regulation	$3.2V \leq V_{IN} \leq 5.5V$		50	150	$\mu V/V$
$\Delta V_{OUT} / \Delta I_{OUT}$	Load Regulation	Sourcing: $0mA \leq I_{OUT} \leq 10mA$		3	50	$\mu V/mA$
		Sinking: $-5mA \leq I_{OUT} \leq 0mA$		130	400	$\mu V/mA$
I_{SC}	Short Circuit Current	$T_A = +25^{\circ}C$, V_{OUT} tied to GND		50		mA
t_R	Turn-on Settling Time	$V_{OUT} = \pm 0.1\%$		300		μs
	Ripple Rejection	$f = 10kHz$		75		dB
e_N	Output Voltage Noise	$0.1Hz \leq f \leq 10Hz$		10		μV_{P-P}

ISL21060

Electrical Specifications (ISL21060-30, $V_{OUT} = 3.000V$) $V_{IN} = 3.5V$, $T_A = -40^{\circ}C$ to $+125^{\circ}C$, $I_{OUT} = 0$, unless otherwise specified.
(Continued)

PARAMETER	DESCRIPTION	CONDITIONS	MIN	TYP	MAX	UNIT
V_N	Broadband Voltage Noise	$10Hz \leq f \leq 1kHz$		2.5		μV_{RMS}
	Noise Density	$f = 1kHz$		60		nV/\sqrt{Hz}
$\Delta V_{OUT}/\Delta T_A$	Thermal Hysteresis (Note 4)	$\Delta T_A = +165^{\circ}C$		100		ppm
$\Delta V_{OUT}/\Delta t$	Long Term Stability (Note 5)	$T_A = +25^{\circ}C$		100		ppm
OUTPUT DISABLE						
V_{ENH}	Enable Logic High (ON)		1.6			V
V_{ENL}	Enable Logic Low (OFF)				0.8	V
I_{INSD}	Shutdown Supply Current	$V_{EN} \leq 0.35V$		0.4	1.5	μA

Electrical Specifications (ISL21060-33, $V_{OUT} = 3.300V$) $V_{IN} = 5.0V$, $T_A = -40^{\circ}C$ to $+125^{\circ}C$, $I_{OUT} = 0$, unless otherwise specified.

PARAMETER	DESCRIPTION	CONDITIONS	MIN	TYP	MAX	UNIT
V_{OUT}	Output Voltage			3.300		V
V_{OA}	V_{OUT} Accuracy @ $T_A = +25^{\circ}C$	ISL21060C33	-2.5		+2.5	mV
TC V_{OUT}	Output Voltage Temperature Coefficient (Note 3)	ISL21060C			25	ppm/ $^{\circ}C$
V_{IN}	Input Voltage Range		3.5		5.5	V
I_{IN}	Supply Current	$EN = V_{IN}$		18	40	μA
$\Delta V_{OUT}/\Delta V_{IN}$	Line Regulation	$3.5V \leq V_{IN} \leq 5.5V$		20	150	$\mu V/V$
$\Delta V_{OUT}/\Delta I_{OUT}$	Load Regulation	Sourcing: $0mA \leq I_{OUT} \leq 10mA$		10	50	$\mu V/mA$
		Sinking: $-5mA \leq I_{OUT} \leq 0mA$		120	400	$\mu V/mA$
I_{SC}	Short Circuit Current	$T_A = +25^{\circ}C$, V_{OUT} tied to GND		50		mA
t_R	Turn-on Settling Time	$V_{OUT} = \pm 0.1\%$		300		μs
	Ripple Rejection	$f = 10kHz$		75		dB
e_N	Output Voltage Noise	$0.1Hz \leq f \leq 10Hz$		10		μV_{P-P}
V_N	Broadband Voltage Noise	$10Hz \leq f \leq 1kHz$		2.5		μV_{RMS}
	Noise Density	$f = 1kHz$		60		nV/\sqrt{Hz}
$\Delta V_{OUT}/\Delta T_A$	Thermal Hysteresis (Note 4)	$\Delta T_A = +165^{\circ}C$		100		ppm
$\Delta V_{OUT}/\Delta t$	Long Term Stability (Note 5)	$T_A = +25^{\circ}C$		100		ppm
OUTPUT DISABLE						
V_{ENH}	Enable Logic High (ON)		1.6			V
V_{ENL}	Enable Logic Low (OFF)				0.8	V
I_{INSD}	Shutdown Supply Current	$V_{EN} \leq 0.35V$		0.4	1.5	μA

ISL21060

Electrical Specifications (ISL21060-41, $V_{OUT} = 4.096V$) $V_{IN} = 5.0V$, $T_A = -40^{\circ}C$ to $+125^{\circ}C$, $I_{OUT} = 0$, unless otherwise specified.

PARAMETER	DESCRIPTION	CONDITIONS	MIN	TYP	MAX	UNIT
V_{OUT}	Output Voltage			4.096		V
V_{OA}	V_{OUT} Accuracy @ $T_A = +25^{\circ}C$	ISL21060B41	-1.0		+1.0	mV
		ISL21060C41	-2.5		+2.5	mV
TC V_{OUT}	Output Voltage Temperature Coefficient (Note 3)	ISL21060B			10	ppm/ $^{\circ}C$
		ISL21060C			25	ppm/ $^{\circ}C$
V_{IN}	Input Voltage Range		4.3		5.5	V
I_{IN}	Supply Current	$EN = V_{IN}$		20	40	μA
$\Delta V_{OUT} / \Delta V_{IN}$	Line Regulation	$4.3V \leq V_{IN} \leq 5.5V$		50	150	$\mu V/V$
$\Delta V_{OUT} / \Delta I_{OUT}$	Load Regulation	Sourcing: $0mA \leq I_{OUT} \leq 10mA$		10	50	$\mu V/mA$
		Sinking: $-5mA \leq I_{OUT} \leq 0mA$		130	400	$\mu V/mA$
I_{SC}	Short Circuit Current	$T_A = +25^{\circ}C$, V_{OUT} tied to GND		50		mA
t_R	Turn on Settling Time	$V_{OUT} = \pm 0.1\%$		300		μs
	Ripple Rejection	$f = 10kHz$		75		dB
e_N	Output Voltage Noise	$0.1Hz \leq f \leq 10Hz$		10		μV_{P-P}
V_N	Broadband Voltage Noise	$10Hz \leq f \leq 1kHz$		2.5		μV_{RMS}
	Noise Density	$f = 1kHz$		60		nV/\sqrt{Hz}
$\Delta V_{OUT} / \Delta T_A$	Thermal Hysteresis (Note 4)	$\Delta T_A = +165^{\circ}C$		100		ppm
$\Delta V_{OUT} / \Delta t$	Long Term Stability (Note 5)	$T_A = +25^{\circ}C$		100		ppm
OUTPUT DISABLE						
V_{ENH}	Enable Logic High (ON)		1.6			V
V_{ENL}	Enable Logic Low (OFF)				0.8	V
I_{INSD}	Shutdown Supply Current	$V_{EN} \leq 0.35V$		0.4	1.5	μA

NOTES:

- Over the specified temperature range. Temperature coefficient is measured by the box method whereby the change in V_{OUT} is divided by the temperature range; in this case, $-40^{\circ}C$ to $+125^{\circ}C = +165^{\circ}C$.
- Thermal Hysteresis is the change of V_{OUT} measured @ $T_A = +25^{\circ}C$ after temperature cycling over a specified range, ΔT_A . V_{OUT} is read initially at $T_A = +25^{\circ}C$ for the device under test. The device is temperature cycled and a second V_{OUT} measurement is taken at $+25^{\circ}C$. The difference between the initial V_{OUT} reading and the second V_{OUT} reading is then expressed in ppm. For $\Delta T_A = +165^{\circ}C$, the device under test is cycled from $+25^{\circ}C$ to $+125^{\circ}C$ to $-40^{\circ}C$ to $+25^{\circ}C$.
- Long term drift is logarithmic in nature and diminishes over time. Drift after the first 1000 hours will be approximately $10ppm/\sqrt{1khrs}$.

Typical Performance Curves (ISL21060-30) ($R_{EXT} = 100k\Omega$)

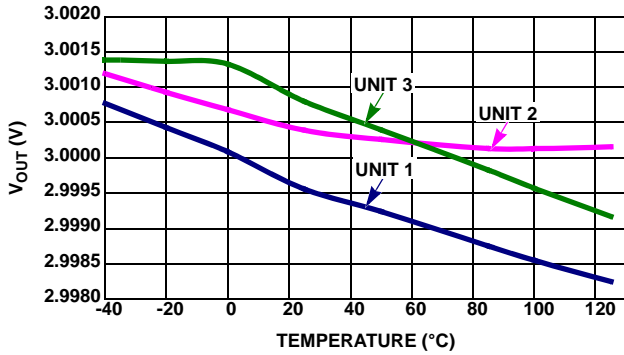

FIGURE 1. V_{OUT} vs TEMPERATURE, 3 UNITS

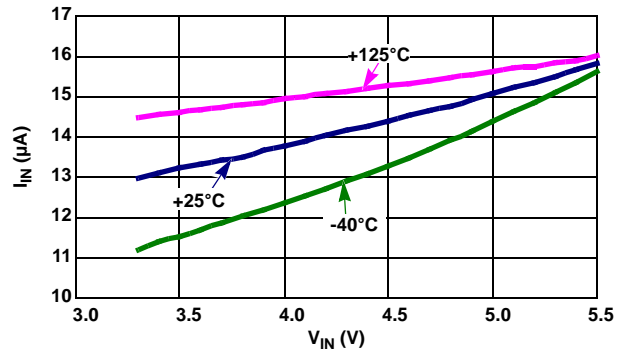

FIGURE 2. I_{IN} vs V_{IN} , 3 TEMPERATURES

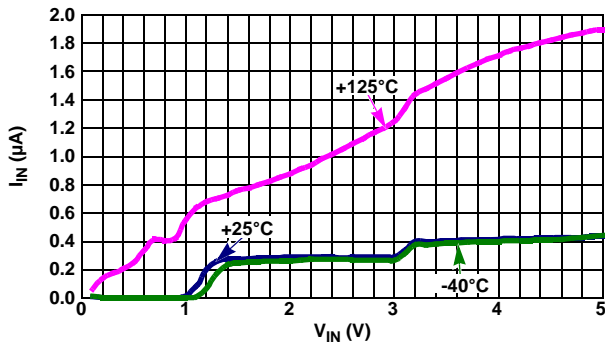

FIGURE 3. I_{IN} vs V_{IN} [SLEEP MODE], 3 TEMPERATURES

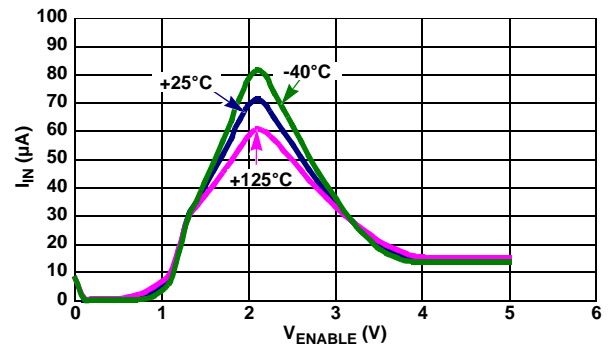

FIGURE 4. I_{IN} vs V_{ENABLE} , 3 TEMPERATURES

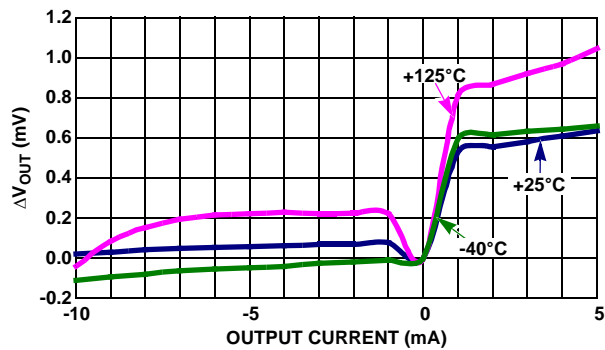

FIGURE 5. LOAD REGULATION

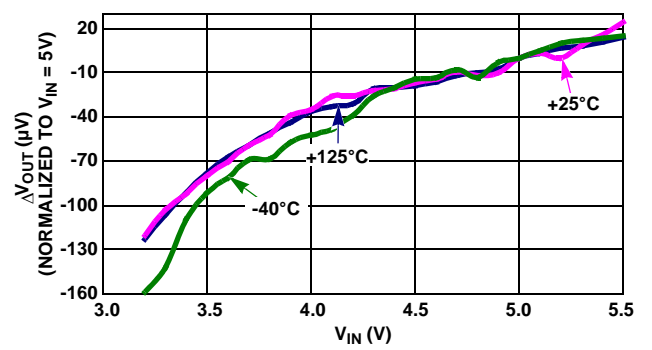

FIGURE 6. LINE REGULATION OVER-TEMPERATURE

Typical Performance Curves (ISL21060-30) ($R_{EXT} = 100k\Omega$) (Continued)

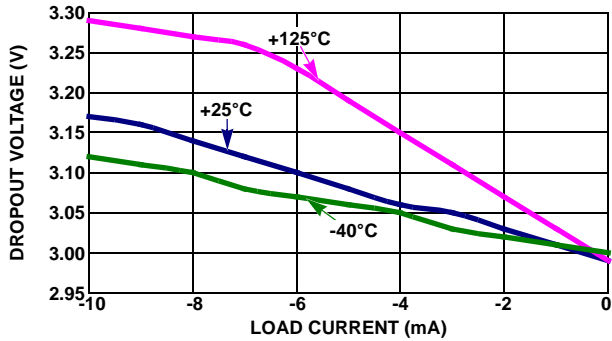

FIGURE 7. LOAD CURRENT vs DROPOUT

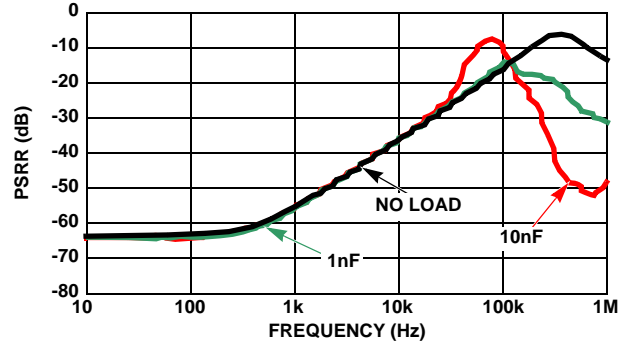

FIGURE 8. PSRR AT DIFFERENT CAPACITIVE LOADS

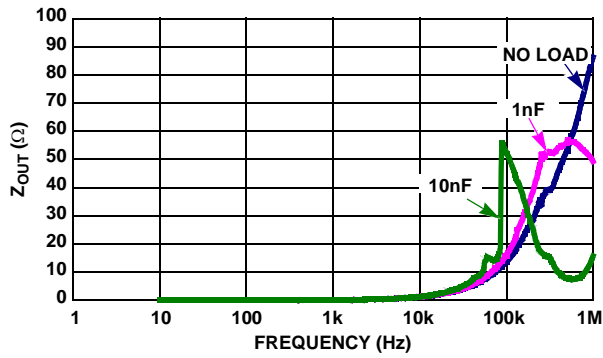

FIGURE 9. Z_{OUT} vs FREQUENCY

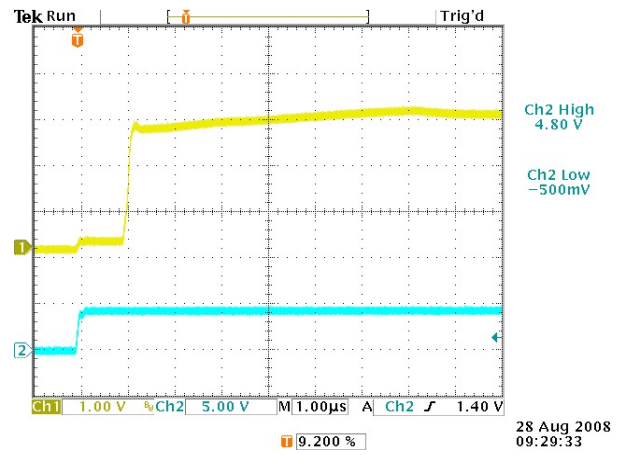

FIGURE 10. TURN-ON TIME, NO LOAD

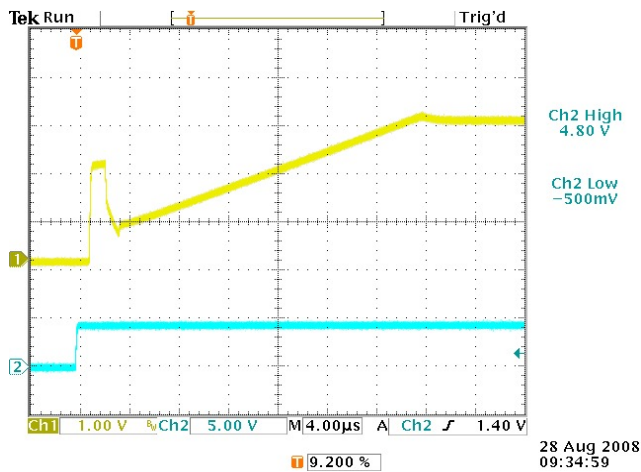

FIGURE 11. TURN-ON TIME, $1k\Omega$

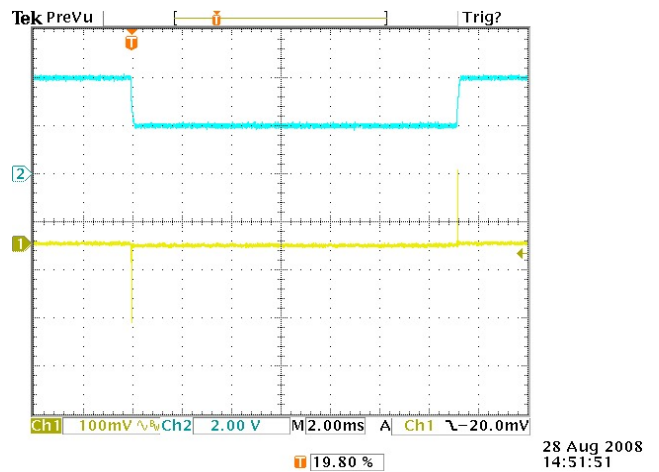

FIGURE 12. LOAD TRANSIENT RESPONSE, $1nF$ LOAD CAPACITANCE

Typical Performance Curves (ISL21060-30) ($R_{EXT} = 100k\Omega$) (Continued)

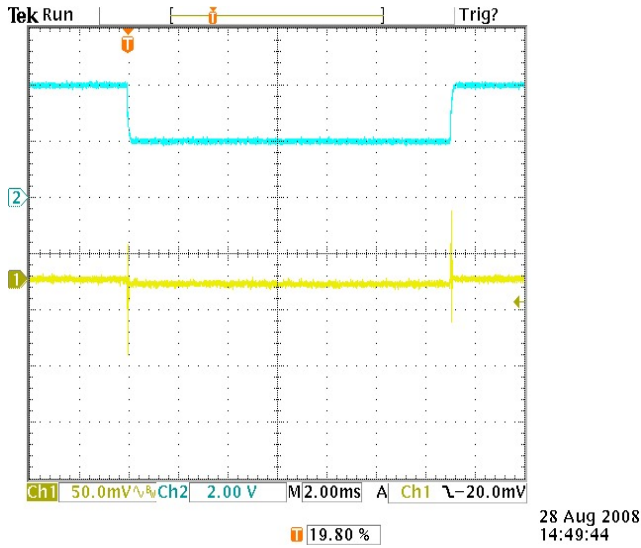

FIGURE 13. LOAD TRANSIENT RESPONSE, 100nF LOAD CAPACITANCE

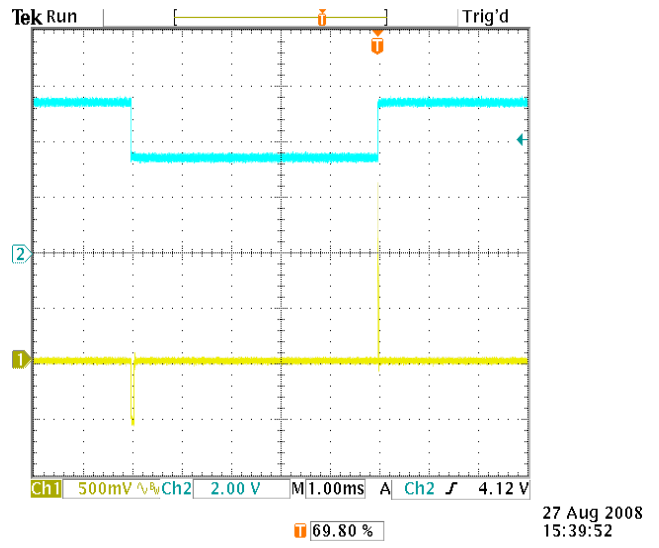

FIGURE 14. LINE TRANSIENT RESPONSE, 1nF LOAD

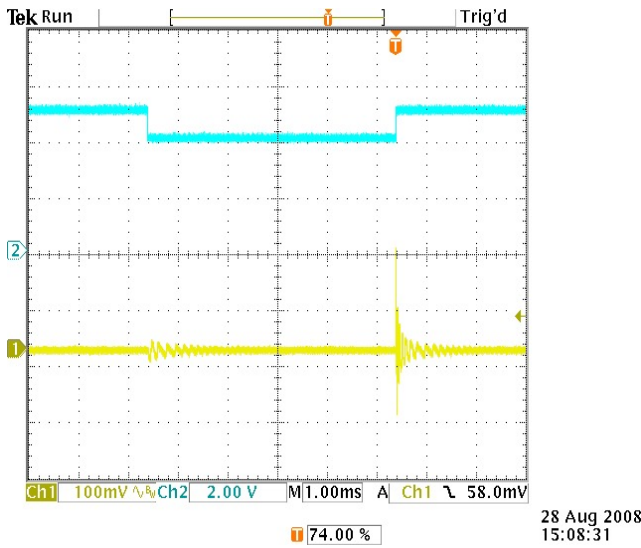

FIGURE 15. LINE TRANSIENT RESPONSE, 100nF

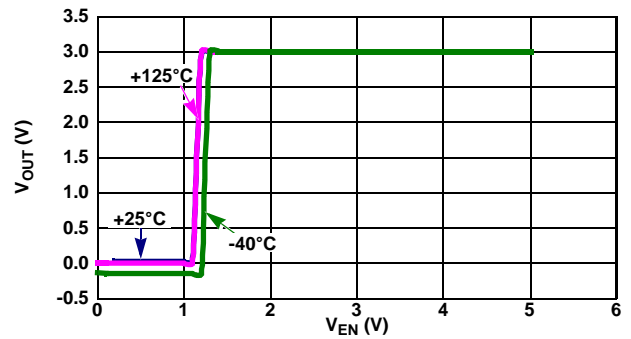

FIGURE 16. V_{OUT} VS V_{ENABLE}

Typical Performance Curves (ISL21060-41) ($R_{EXT} = 100k\Omega$)

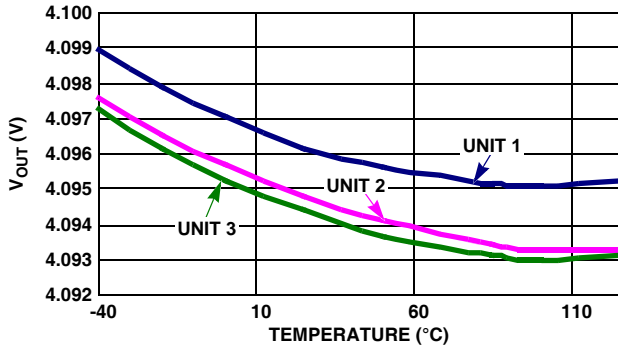

FIGURE 17. V_{OUT} vs TEMPERATURE, 3 UNITS

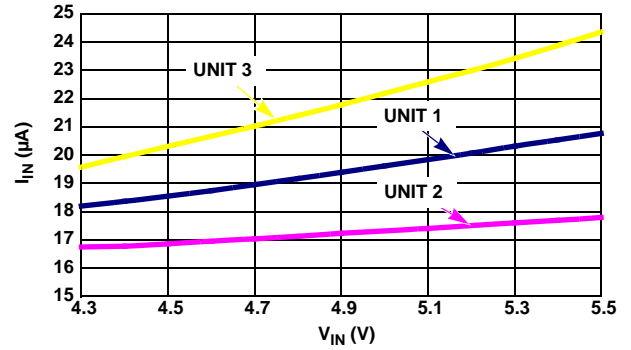

FIGURE 18. I_{IN} vs V_{IN} , 3 TEMPERATURES

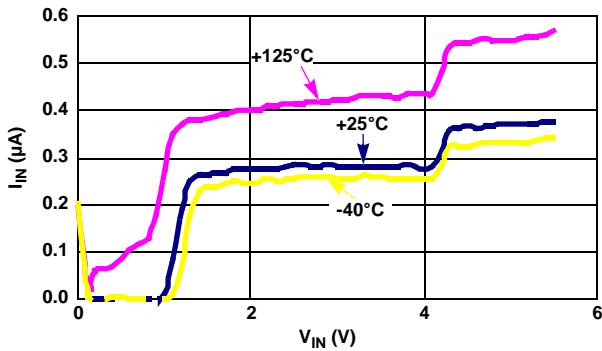

FIGURE 19. I_{IN} vs V_{IN} [SLEEP MODE], 3 TEMPERATURES

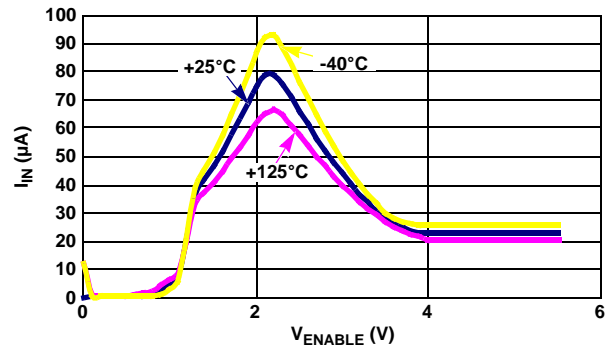

FIGURE 20. I_{IN} vs V_{ENABLE} , 3 TEMPERATURES

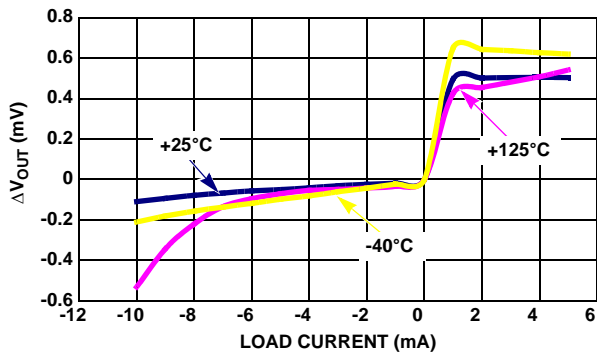

FIGURE 21. LOAD REGULATION

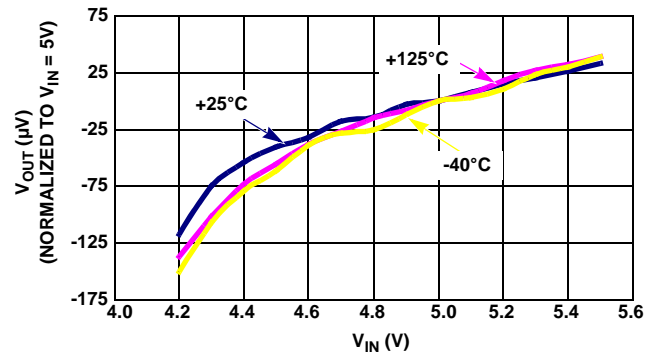

FIGURE 22. LINE REGULATION OVER-TEMPERATURE

Typical Performance Curves (ISL21060-41) ($R_{EXT} = 100k\Omega$) (Continued)

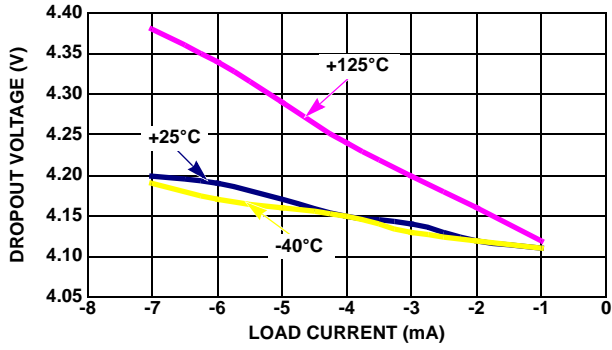

FIGURE 23. LOAD CURRENT vs DROPOUT

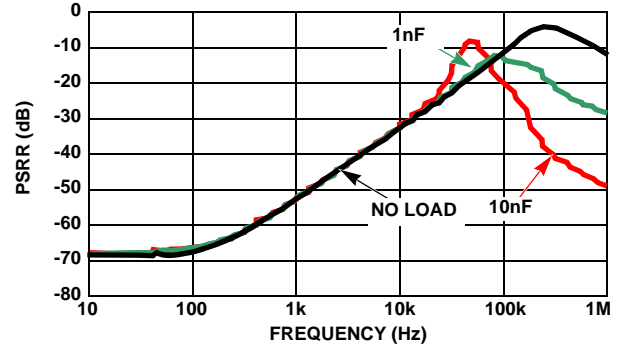

FIGURE 24. PSRR AT DIFFERENT CAPACITIVE LOADS

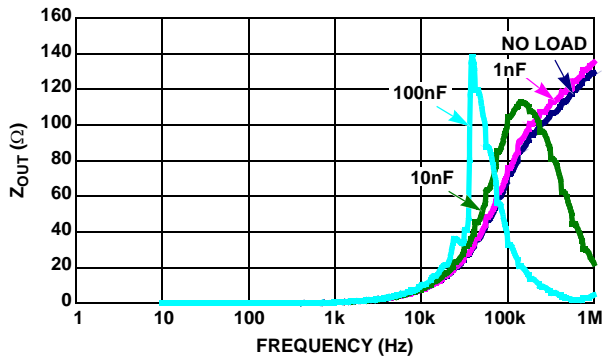

FIGURE 25. Z_{OUT} vs FREQUENCY

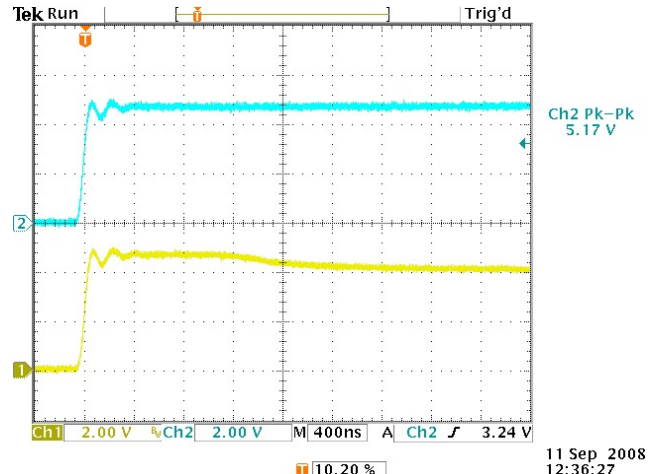

FIGURE 26. TURN-ON TIME, NO LOAD

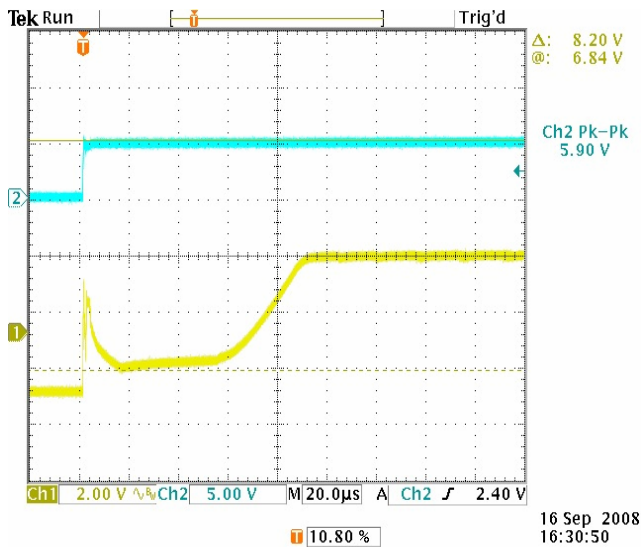

FIGURE 27. TURN-ON TIME, $1k\Omega$

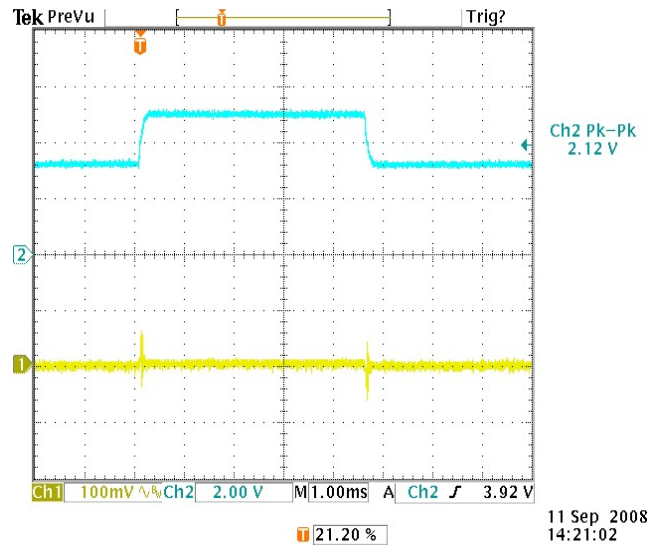

FIGURE 28. LOAD TRANSIENT RESPONSE, $100nF$ LOAD CAPACITANCE

Typical Performance Curves (ISL21060-41) ($R_{EXT} = 100k\Omega$) (Continued)

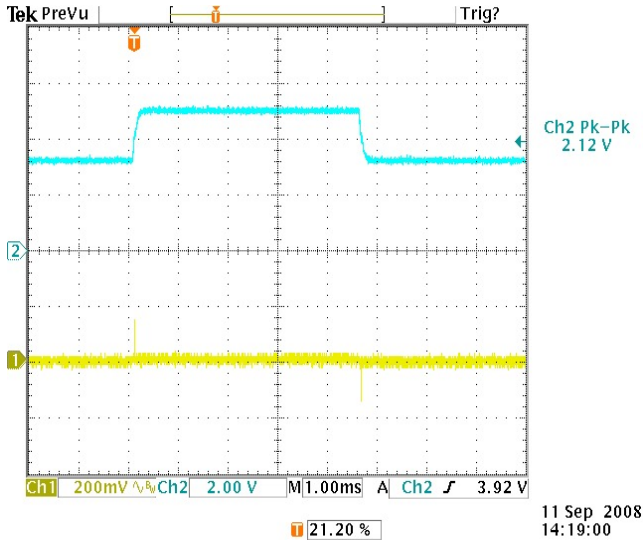

FIGURE 29. LOAD TRANSIENT RESPONSE, 1nF LOAD CAPACITANCE

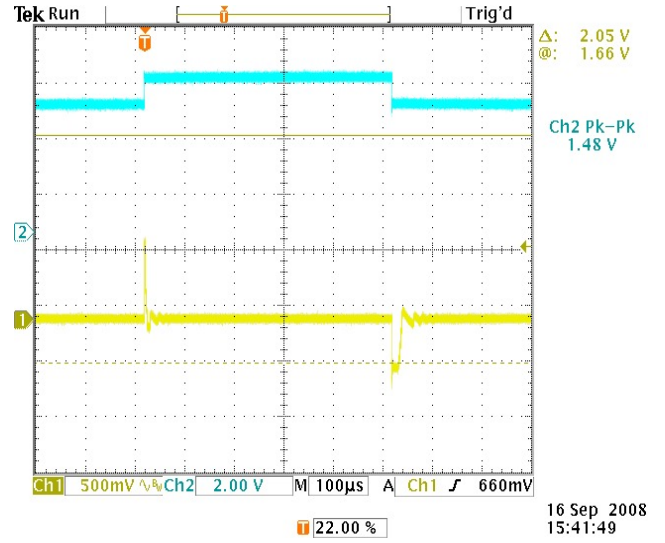

FIGURE 30. LINE TRANSIENT RESPONSE, 1nF LOAD

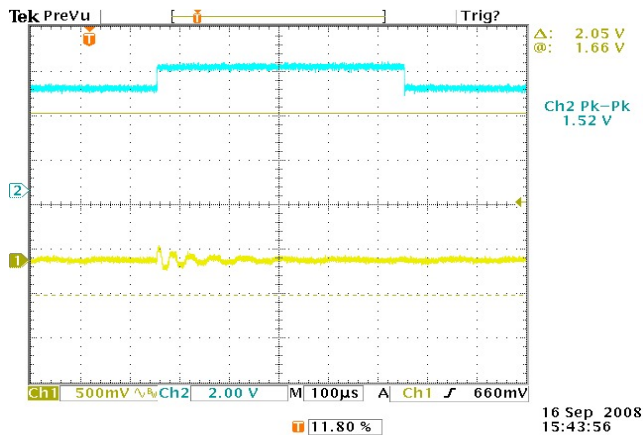

FIGURE 31. LINE TRANSIENT RESPONSE, 100nF LOAD CAPACITANCE

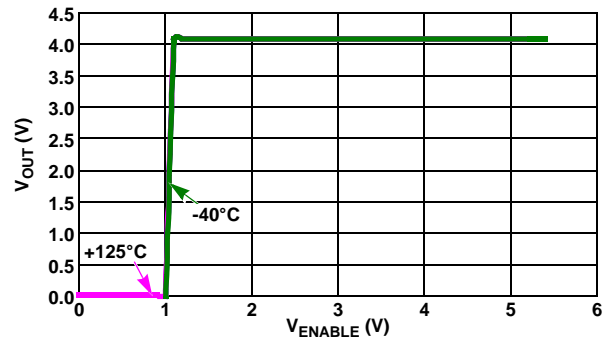

FIGURE 32. V_{OUT} vs V_{ENABLE}

Typical Performance Curves (ISL21060-25) ($R_{EXT} = 100k\Omega$)

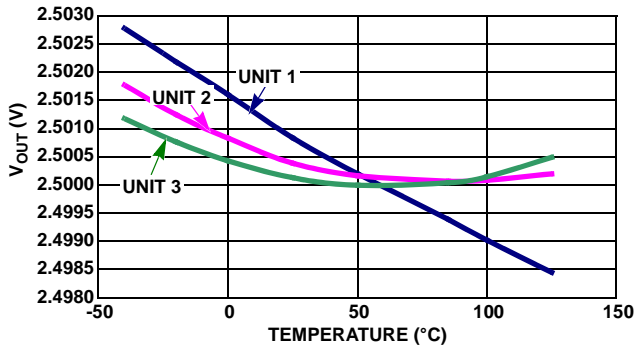

FIGURE 33. V_{OUT} vs TEMPERATURE, 3 UNITS

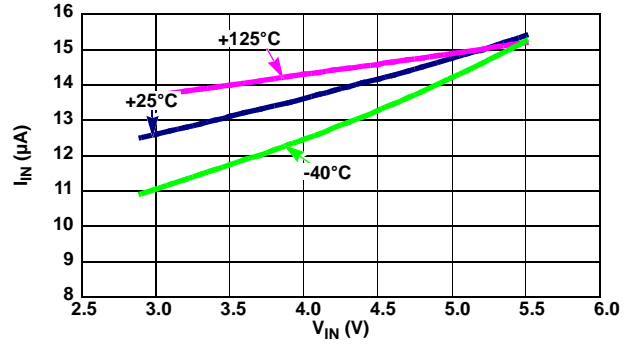

FIGURE 34. I_{IN} vs V_{IN} , 3 TEMPERATURES

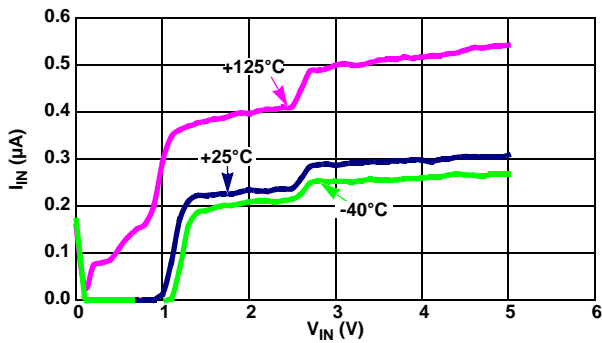

FIGURE 35. I_{IN} vs V_{IN} [SLEEP MODE], 3 TEMPERATURES

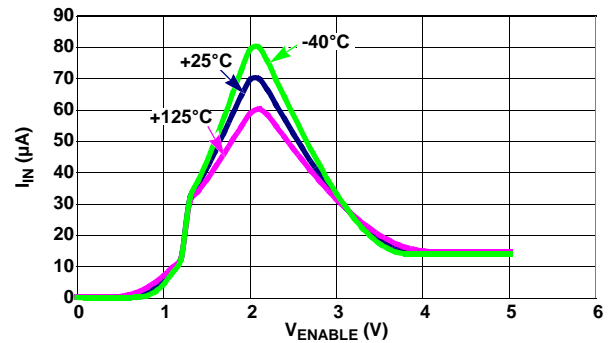

FIGURE 36. I_{IN} vs V_{ENABLE} , 3 TEMPERATURES



FIGURE 37. LOAD REGULATION

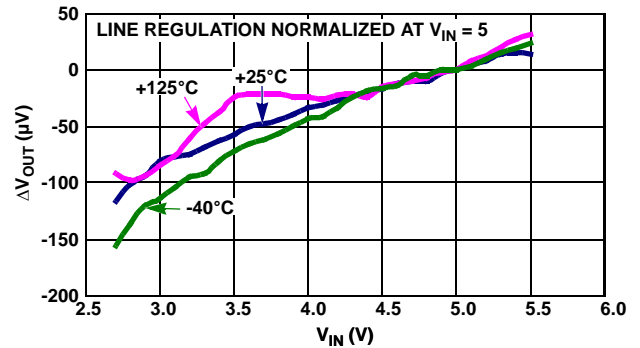

FIGURE 38. LINE REGULATION OVER-TEMPERATURE

Typical Performance Curves (ISL21060-25) ($R_{EXT} = 100k\Omega$) (Continued)

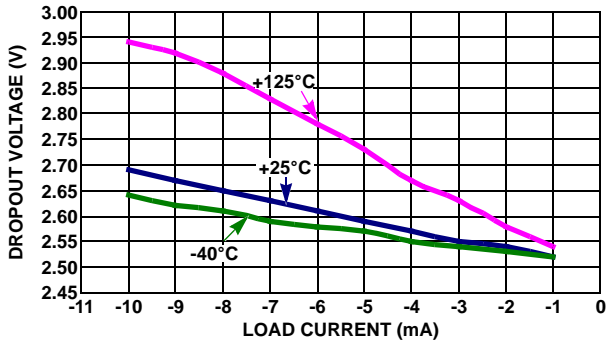

FIGURE 39. LOAD CURRENT vs DROPOUT

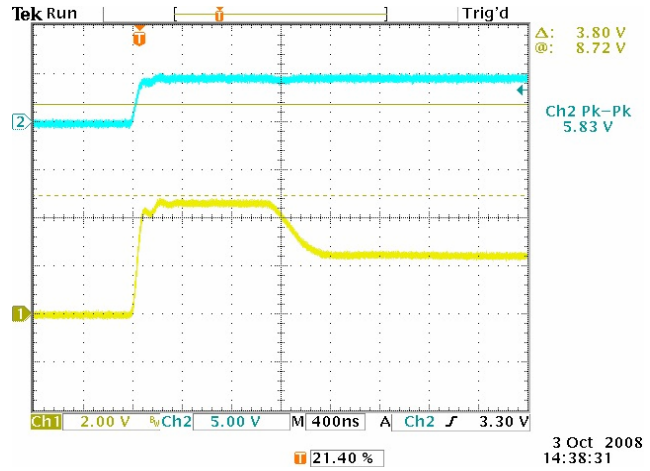

FIGURE 40. TURN-ON TIME, NO LOAD

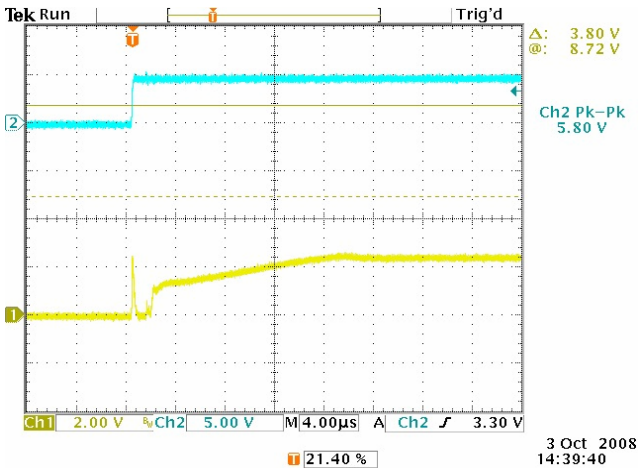

FIGURE 41. TURN-ON TIME, 1kΩ

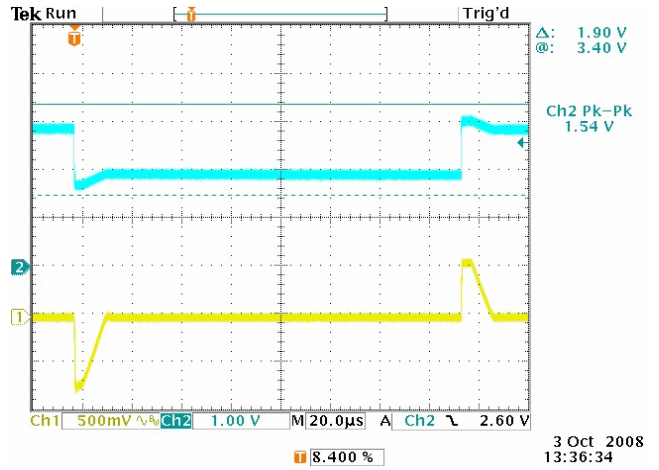

FIGURE 42. LOAD TRANSIENT RESPONSE, 1nF LOAD CAPACITANCE

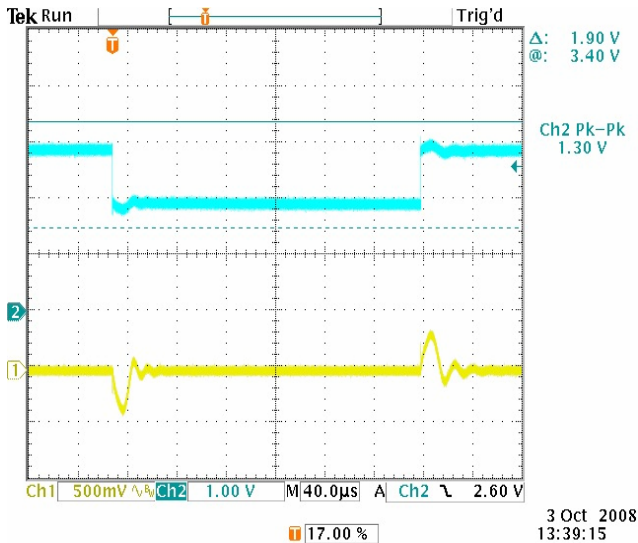

FIGURE 43. LOAD TRANSIENT RESPONSE, 100nF LOAD CAPACITANCE

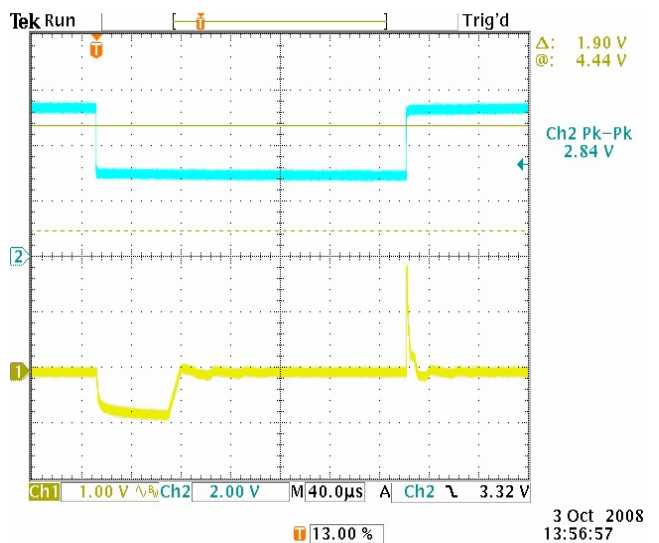

FIGURE 44. LINE TRANSIENT RESPONSE, 1nF LOAD

Typical Performance Curves (ISL21060-25) ($R_{EXT} = 100k\Omega$) (Continued)

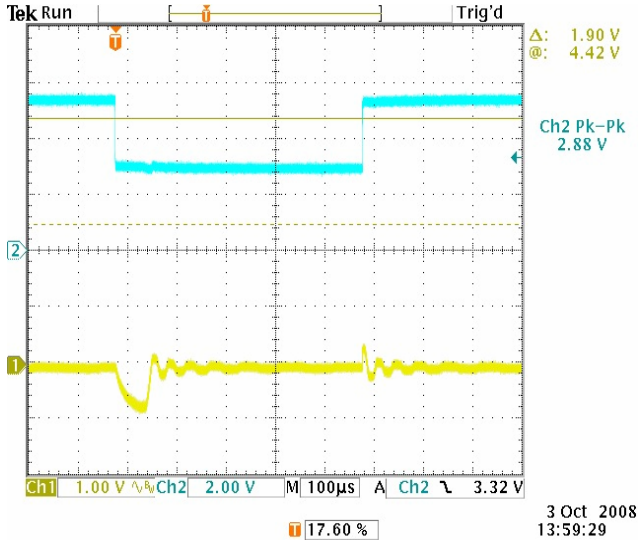

FIGURE 45. LINE TRANSIENT RESPONSE, 100nF

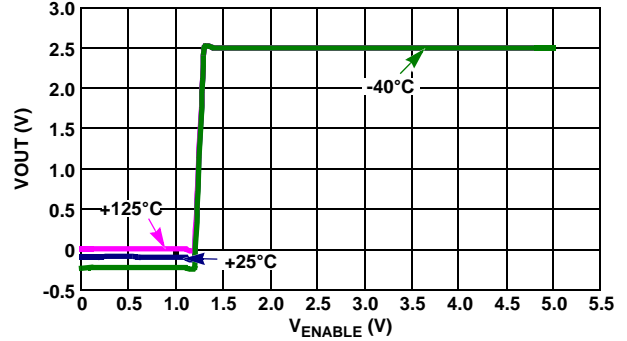

FIGURE 46. V_{OUT} VS V_{ENABLE}

Typical Performance Curves (ISL21060-20) ($R_{EXT} = 100k\Omega$)

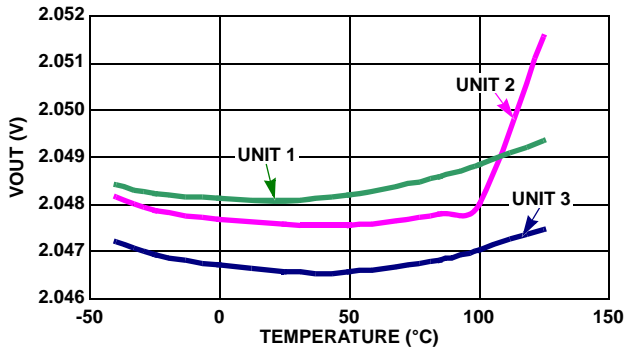

FIGURE 47. V_{OUT} VS TEMPERATURE, 3 UNITS

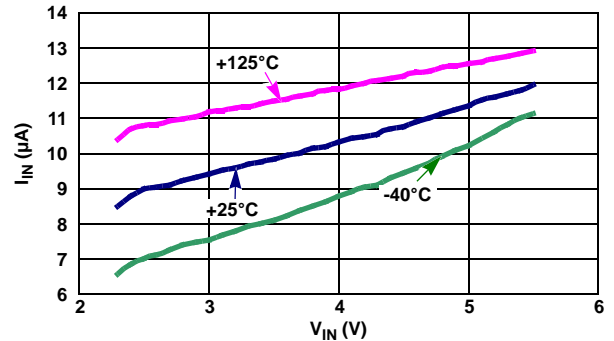

FIGURE 48. I_{IN} VS V_{IN} , 3 TEMPERATURES

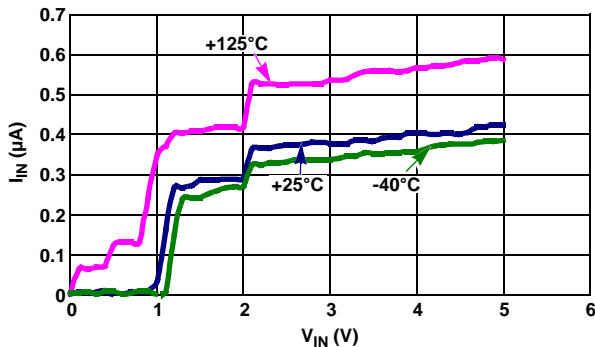

FIGURE 49. I_{IN} VS V_{IN} [SLEEP MODE], 3 TEMPERATURES

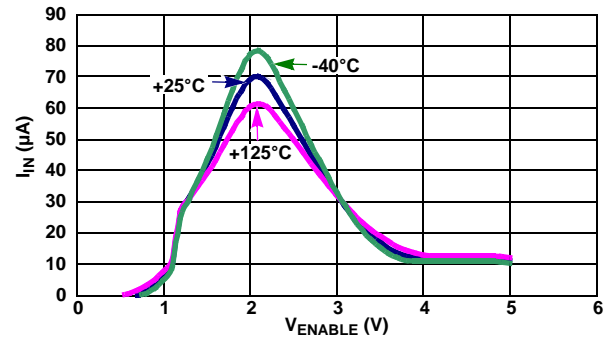

FIGURE 50. I_{IN} VS V_{ENABLE} , 3 TEMPERATURES

Typical Performance Curves (ISL21060-20) ($R_{EXT} = 100k\Omega$) (Continued)

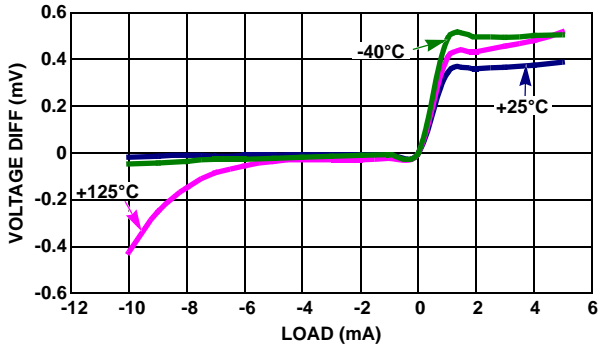

FIGURE 51. LOAD REGULATION

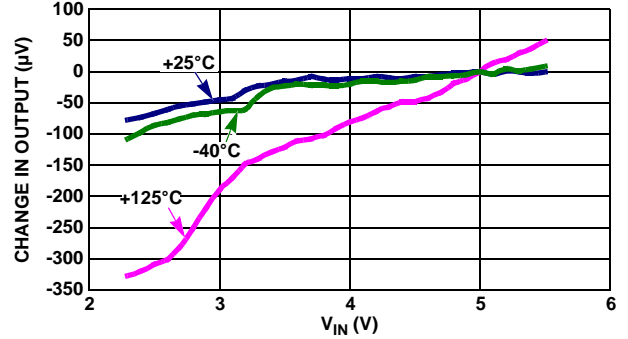

FIGURE 52. LINE REGULATION OVER-TEMPERATURE

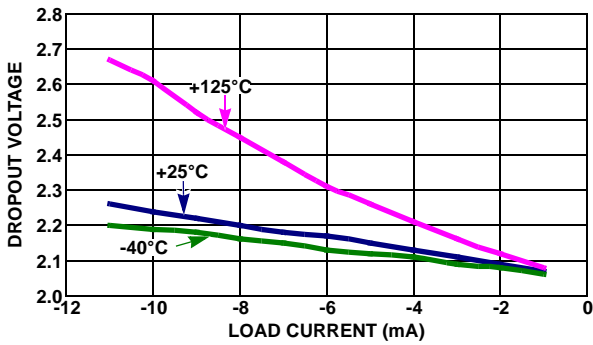

FIGURE 53. LOAD CURRENT vs DROPOUT

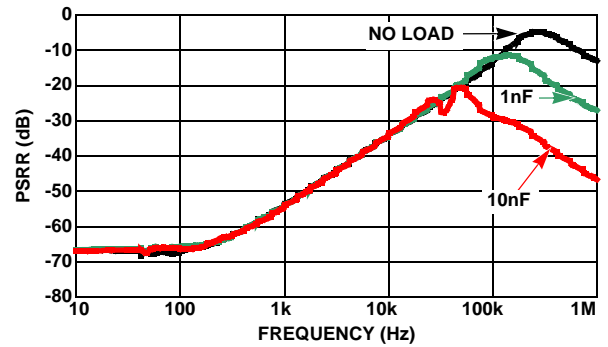

FIGURE 54. PSRR AT DIFFERENT CAPACITIVE LOADS

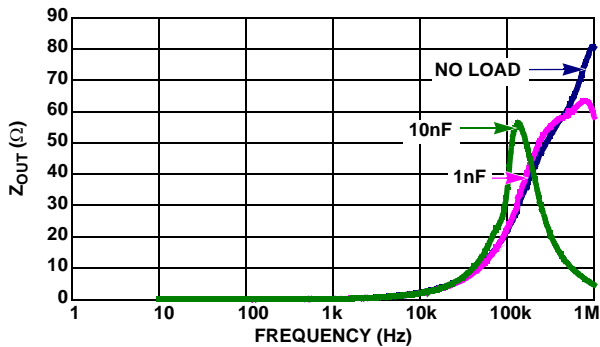

FIGURE 55. Z_{OUT} vs FREQUENCY

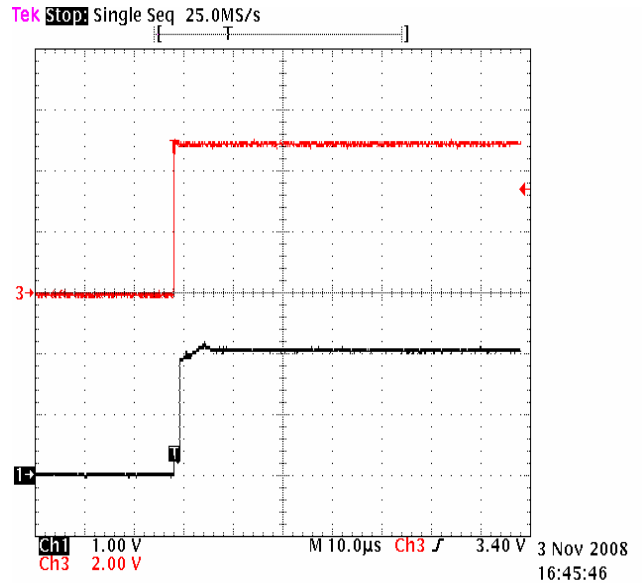

FIGURE 56. TURN-ON TIME, NO LOAD

Typical Performance Curves (ISL21060-20) ($R_{EXT} = 100k\Omega$) (Continued)

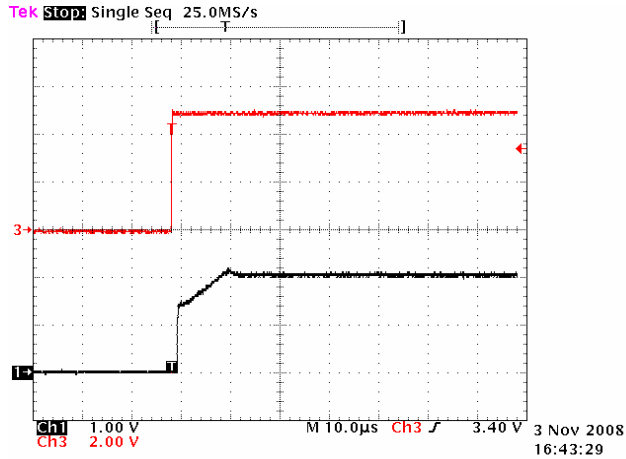

FIGURE 57. TURN-ON TIME, 1kΩ

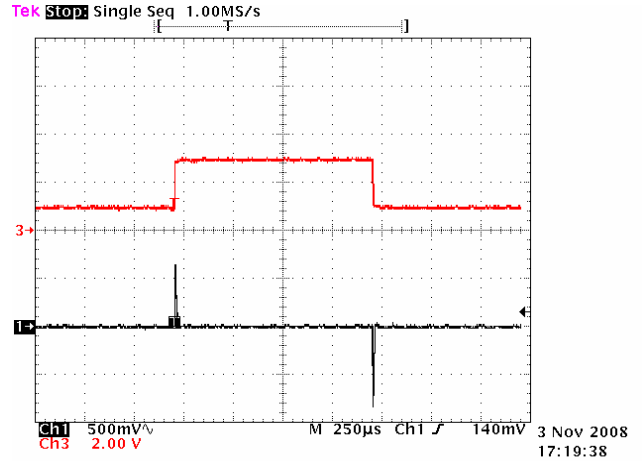

FIGURE 58. LOAD TRANSIENT RESPONSE, 1nF LOAD CAPACITANCE

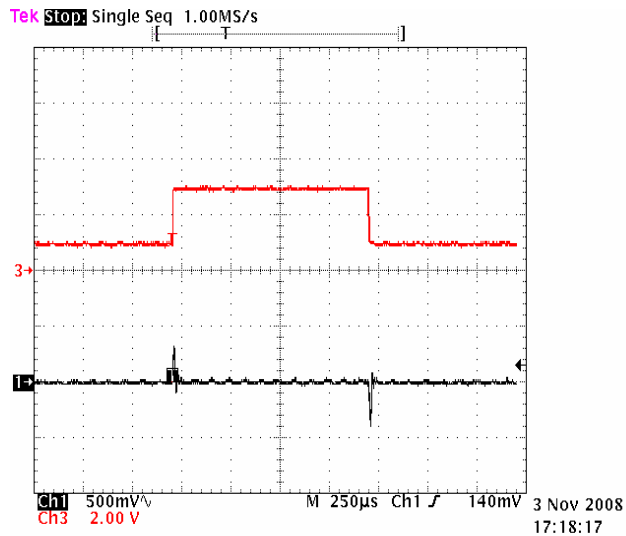

FIGURE 59. LOAD TRANSIENT RESPONSE, 100nF LOAD CAPACITANCE

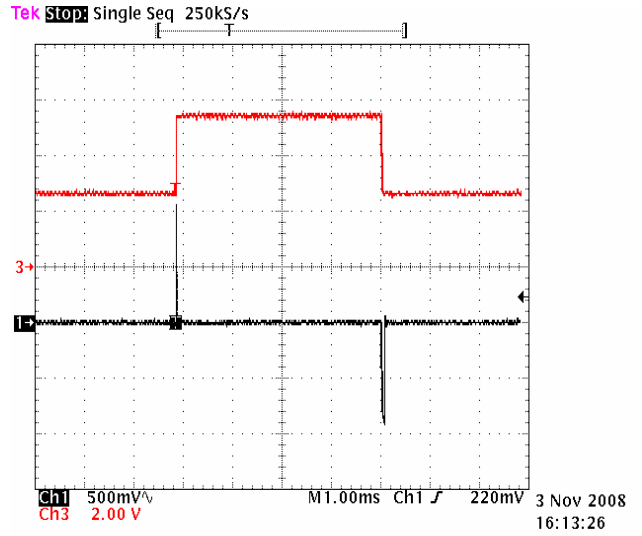

FIGURE 60. LINE TRANSIENT RESPONSE, 1nF LOAD

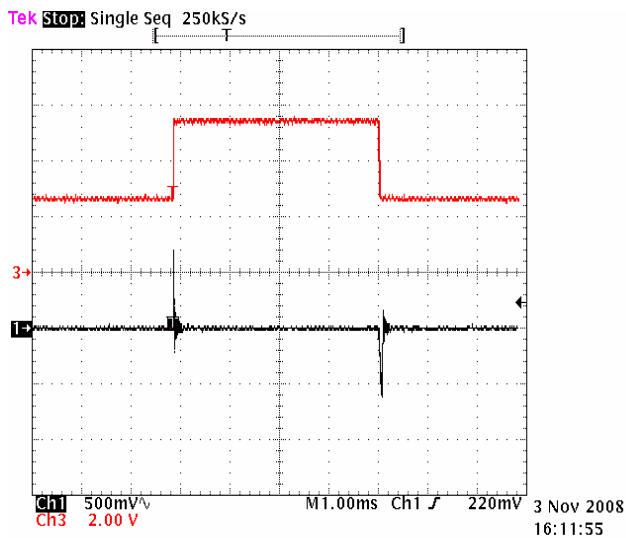

FIGURE 61. LINE TRANSIENT RESPONSE, 100nF

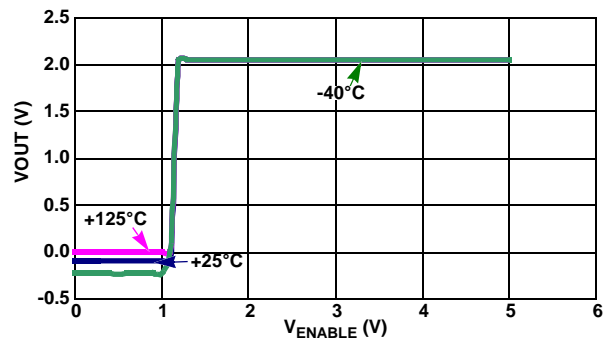

FIGURE 62. V_{OUT} VS V_{ENABLE}

FGA Technology

The ISL21060 voltage reference floating gate references passes very low drift and supply current. The charge stored on a floating gate cell is set precisely in manufacturing. The reference voltage output itself is a buffered version of the floating gate voltage. The resulting reference device has excellent characteristics which are unique in the industry and include very low temperature drift, high initial accuracy, and almost zero supply current. Also, the reference voltage itself is not limited by voltage bandgaps or zener settings, so a wide range of reference voltages can be programmed (standard voltage settings are provided, but customer-specific voltages are available).

The process used for these reference devices is a floating gate CMOS process, and the amplifier circuitry uses CMOS transistors for amplifier and output drive. This circuitry provides excellent accuracy with a trade-off in output noise level and load regulation due to the MOS device characteristics. These limitations are addressed with circuit techniques discussed in other sections.

Micropower Supply Current and Output Enable

The ISL21060 consumes extremely low supply current due to the proprietary FGA technology. Low noise performance is achieved using optimized biasing techniques. Supply current is typically 16 μ A and noise is 10 μ V_{P-P}, benefitting precision, low noise portable applications, such as handheld meters and instruments.

The ISL21060 devices have the EN pin, which is used to Enable/Disable the output of the device. When disabled, the reference circuitry itself remains biased at a highly accurate and reliable state. When enabled, the output is driven to the reference voltage in a relatively short time (about 300 μ s). This feature allows multiple references to be connected and one of them selected. Another application is to disable any loads that draw significant current, saving power in standby or shutdown modes.

Board Mounting Considerations

For applications requiring the highest accuracy, board mounting location should be reviewed. The device uses a plastic SOIC package, which will subject the die to mild stresses when the PC board is heated and cooled and slightly changes shape. Placing the device in areas subject to slight twisting can cause degradation of the accuracy of the reference voltage due to these die stresses. It is normally best to place the device near the edge of a board, or the shortest side, as the axis of bending is most limited at that location. Mounting the device in a cutout also minimizes flex. Obviously, mounting the device on flexprint or extremely thin PC material will likewise cause loss of reference accuracy.

Noise Performance and Reduction

The output noise voltage in a 0.1Hz to 10Hz bandwidth is typically 10 μ V_{P-P}. The noise measurement is made with a

bandpass filter made of a 1-pole high-pass filter with a corner frequency at 0.1Hz and a 2-pole low-pass filter with a corner frequency at 12.6Hz to create a filter with a 9.9Hz bandwidth. Noise in the 10kHz to 1MHz bandwidth is approximately 100 μ V_{P-P} with no capacitance on the output. This noise measurement is made with a 2 decade bandpass filter made of a 1-pole high-pass filter with a corner frequency at 1/10 of the center frequency and 1-pole low-pass filter with a corner frequency at 10x the center frequency. Load capacitance up to 1 μ F can be added to improve transient response.

Turn-On Time

The ISL21060 devices have low supply current and thus the time to bias-up internal circuitry to final values will be longer than with higher power references. Normal turn-on time is typically 300 μ s. Circuit design must take this into account when looking at power-up delays or sequencing.

Temperature Coefficient

The limits stated for temperature coefficient (tempco) are governed by the method of measurement. The overwhelming standard for specifying the temperature drift of a reference is to measure the reference voltage at two temperatures take the total variation, ($V_{HIGH} - V_{LOW}$), and divide by the temperature extremes of measurement ($T_{HIGH} - T_{LOW}$). The result is divided by the nominal reference voltage (at $T = +25^{\circ}C$) and multiplied by 10^6 to yield ppm/ $^{\circ}C$. This is the "Box" method for specifying temperature coefficient.

VOUT Kelvin Sensing

The voltage output for the ISL21060 has both a force and a sense output. This enables remote kelvin sensing for highly accurate voltage setting with long traces and higher current loads. The VOUTF (force) can be routed to the load with the shortest, widest trace possible. The VOUTS (sense) is routed with a narrower trace to the point of the actual load where it is connected to the VOUTF trace.

The VOUTF and VOUTS traces must always be connected. If there is only a short trace to the load or even a very light load, then they can be connected at or near the ISL21060 device.

Typical Application Circuits

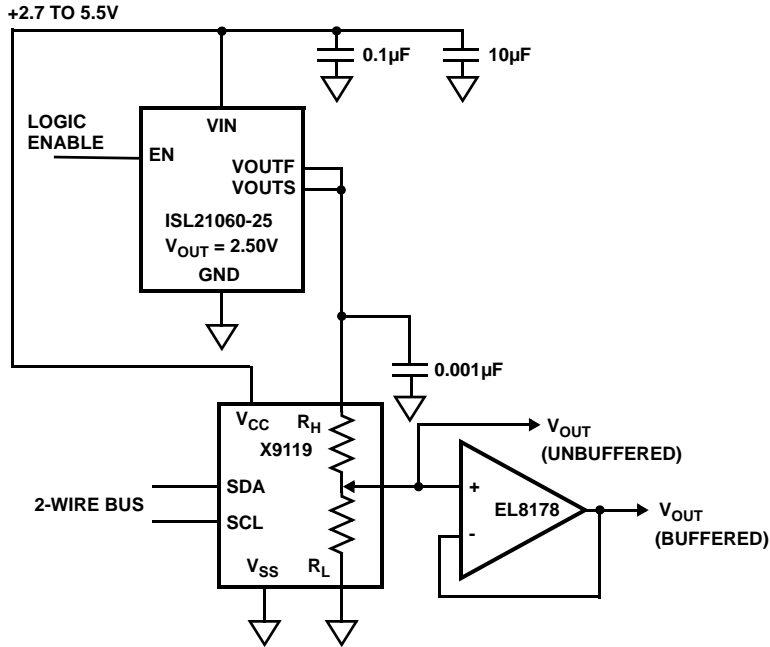

FIGURE 63. 2.5V FULL SCALE LOW-DRIFT, 10-BIT ADJUSTABLE VOLTAGE SOURCE WITH LOW POWER DISABLE

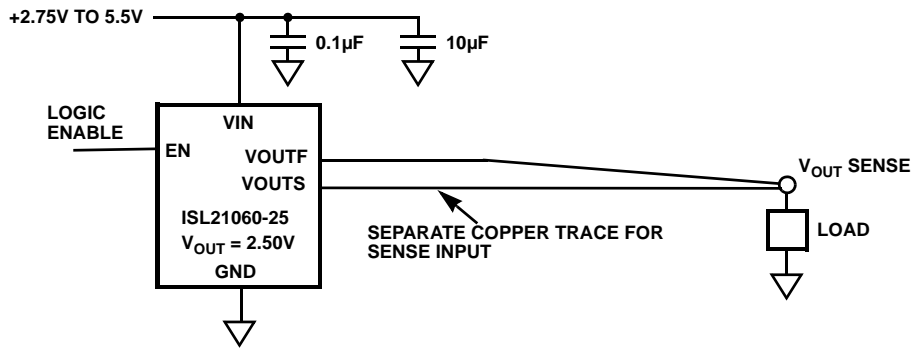
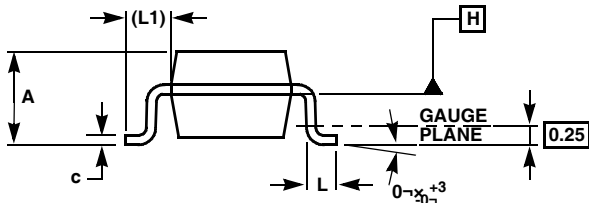
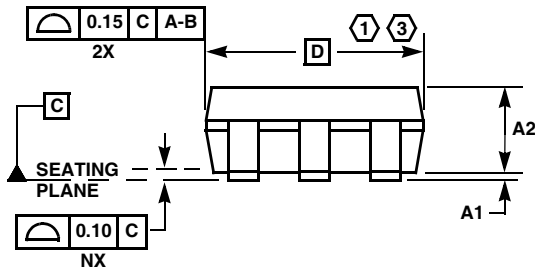
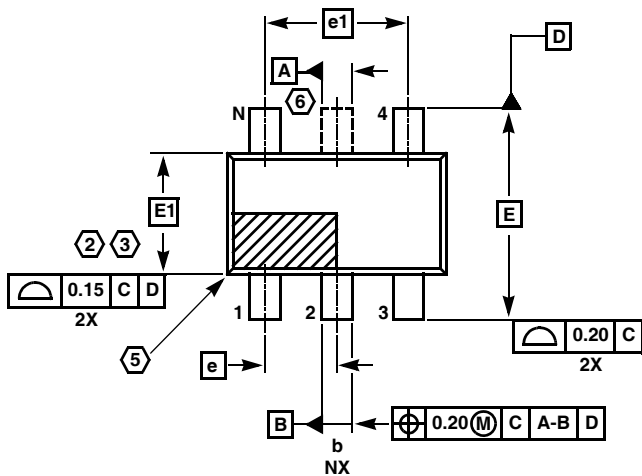

FIGURE 64. KELVIN SENSED LOAD

SOT-23 Package Family



MDP0038

SOT-23 PACKAGE FAMILY

SYMBOL	MILLIMETERS		TOLERANCE
	SOT23-5	SOT23-6	
A	1.45	1.45	MAX
A1	0.10	0.10	±0.05
A2	1.14	1.14	±0.15
b	0.40	0.40	±0.05
c	0.14	0.14	±0.06
D	2.90	2.90	Basic
E	2.80	2.80	Basic
E1	1.60	1.60	Basic
e	0.95	0.95	Basic
e1	1.90	1.90	Basic
L	0.45	0.45	±0.10
L1	0.60	0.60	Reference
N	5	6	Reference

Rev. F 2/07

NOTES:

1. Plastic or metal protrusions of 0.25mm maximum per side are not included.
2. Plastic interlead protrusions of 0.25mm maximum per side are not included.
3. This dimension is measured at Datum Plane "H".
4. Dimensioning and tolerancing per ASME Y14.5M-1994.
5. Index area - Pin #1 I.D. will be located within the indicated zone (SOT23-6 only).
6. SOT23-5 version has no center lead (shown as a dashed line).

All Intersil U.S. products are manufactured, assembled and tested utilizing ISO9000 quality systems. Intersil Corporation's quality certifications can be viewed at www.intersil.com/design/quality

Intersil products are sold by description only. Intersil Corporation reserves the right to make changes in circuit design, software and/or specifications at any time without notice. Accordingly, the reader is cautioned to verify that data sheets are current before placing orders. Information furnished by Intersil is believed to be accurate and reliable. However, no responsibility is assumed by Intersil or its subsidiaries for its use; nor for any infringements of patents or other rights of third parties which may result from its use. No license is granted by implication or otherwise under any patent or patent rights of Intersil or its subsidiaries.

For information regarding Intersil Corporation and its products, see www.intersil.com